



# ARGO NAVIS™

## User Manual

Edition 11, Dec 2014, for ARGO NAVIS™ Model 102 & 102B,  
Firmware version 3.0.0



ARGO NAVIS™

## Congratulations

You have purchased one of the most sophisticated devices for rapidly and confidently locating celestial objects. The ARGO NAVIS™ Digital Telescope Computer (DTC) brings not only accurate positioning information to your telescope but also provides an enormous detailed database of tens of thousands of objects.

Stars, galaxies, galaxy clusters, globular clusters, open clusters, planetary nebulae, nebulae, planets, asteroids, comets, earth-orbiting satellites and more.

Magnitudes, surface brightness, object sizes, common names, stellar classifications, stellar luminosity classes, double star separations, variable star periods, Hubble galaxy morphologies, constellation, detailed parameters of planets, comets, asteroids, satellites, Moon phases and a wealth of other information are available at your fingertips with a simple spin of the dial.

A large range of mounts can accommodate the ARGO NAVIS™ including Dobsonians, Forks, German Equatorials and Equatorial Tables.

Handheld and powered by AA batteries, or an optional external DC source, ARGO NAVIS™ operates completely standalone.

After fitting a pair of optical encoders to your mount, using the ARGO NAVIS™ is simple. Perform a quick star alignment and off you go. There is no need to level or accurately polar align your mount. It's fast and easy.

Using the innovative, *Intelligent Editing System™*, objects from the in-built

catalogs can be accessed quickly and easily by name. You can select a particular object and then ARGO NAVIS™ can provide you with “guiding” information that will allow you to zero-in on it by simply manually turning the scope.

Alternatively, objects of interest can be reported to you on the display in real-time as you move your scope. ARGO NAVIS™ has a powerful 32-bit CPU at its heart that will easily allow you to continuously track satellites. The sophisticated software even accounts for precession, nutation and atmospheric refraction. A battery backed real-time clock provides local time, UTC time, Julian date and sidereal time.

The versatile and powerful tour mode allows you to tailor your searches of the sky so that you may seek to find the types of objects that interest you the most, be they easy or highly challenging.

Though designed for standalone use, ARGO NAVIS™ can also be interfaced to your PC, laptop, tablet or smartphone which brings about a wealth of additional features. It can operate with many of the popular sky charting packages to provide you with a tracking cursor display. Using the supplied ARGONAUT™ utility, it even lets you store into its FLASH memory over a thousand of your own user-defined objects including magnitudes and descriptions. You can erase them and store new ones as often as you like.

This User Manual shows how the ARGO NAVIS™ Digital Telescope Computer can make your observing sessions more enjoyable and rewarding.



# Contents

This manual .....	6
The ARGO NAVIS interfaces .....	8
The user interface .....	8
The encoder interface .....	9
The serial interface.....	10
Initial setup of the ARGO NAVIS .....	12
Power sources .....	12
Setting the initial mount type .....	14
Setting encoder steps (resolution).....	14
Setting altitude steps.....	15
Setting azimuth steps.....	15
Testing encoder communication.....	16
Determining encoder direction senses .....	17
Setting the final mount type.....	18
Setting the local time zone, date and time.....	20
Setting the location.....	22
Setting refraction modelling.....	24
Alignment procedures.....	25
Purpose of alignment .....	25
Fork Exact Align and German Equatorial Exact Align Mounts .....	25
Alt/Az Dobsonian Mounts including on Equatorial Tables.....	26
Fork Rough Align Mounts.....	28
GEM Rough Align .....	29
An introductory run .....	32
Operating modes .....	37
MODE ALIGN .....	38
MODE ALIGN STAR.....	40
MODE AZ ALT .....	44
MODE CATALOG.....	45
MODE ENCODER .....	52
MODE EQ TABLE.....	56
MODE FIX ALT REF .....	59
MODE IDENTIFY.....	63
MODE RA DEC.....	69
MODE SETUP .....	71
MODE SIDEREAL .....	73
MODE STATUS.....	74
MODE TIME .....	75
MODE TIMER.....	76
MODE TOUR.....	77
SETUP ALIGN PICK.....	84



SETUP ALT REF .....	86
SETUP ALT STEPS.....	88
SETUP ARCHIVE.....	89
SETUP ATLAS .....	94
SETUP AZ STEPS.....	96
SETUP BRIGHTNESS.....	97
SETUP CONTRAST .....	98
SETUP DATE/TIME.....	99
SETUP DEBUG .....	102
SETUP DEFAULTS .....	103
SETUP ENC TIMING.....	104
SETUP EQ TABLE .....	107
SETUP GOTO .....	109
SETUP GUIDE MODE.....	112
SETUP LCD HEATER .....	115
SETUP LOAD CAT .....	116
SETUP LOCATION.....	118
SETUP MOUNT.....	121
SETUP MNT ERRORS.....	122
SETUP REFRACTION.....	150
SETUP SCRATCH.....	152
SETUP SCROLL.....	154
SETUP SERIAL .....	155
ARGONAUT software utility Version 2.0 .....	159
ARGONAUT™ Version 2.0 introduction.....	159
What does ARGONAUT™ do?.....	159
What else do I need besides ARGONAUT™? .....	159
Installing ARGONAUT™ .....	160
Launching ARGONAUT™ .....	168
Establishing communication.....	168
Where to obtain Asteroid, Comet or Satellite Orbital Element Files .....	173
How to create your own User catalog files.....	174
Transferring catalog files .....	176
Updating catalog entries.....	179
Deleting loadable catalogs .....	180
Querying loadable catalog free memory.....	181
Transferring setups .....	181
Transferring firmware files.....	186
Setting the date/time from your PC to ARGO NAVIS™ .....	188
Scaling the ARGO NAVIS™ time-of-day clock.....	190
Linux™ operating system file transfer utilities .....	196
Mac OS X™ operating system file transfer utility .....	197
Using ARGO NAVIS with the <i>ServoCAT</i> Track/GOTO Controller.....	198



ARGO NAVIS™

<i>ServoCAT</i> introduction.....	198
Interfacing to <i>ServoCAT</i> <sup>™</sup> and setups configuration .....	198
Operation with <i>ServoCAT</i> <sup>™</sup> .....	199
SmartTrack <sup>™</sup> .....	199
Tracking artificial satellites .....	200
Programmer's reference .....	203
asteroid.....	204
comet.....	205
date.....	206
enc.....	207
encctl .....	208
event.....	209
fp .....	210
meade.....	211
navis .....	213
pbt.....	214
rad .....	215
samples .....	216
satellite .....	217
servocat .....	218
setups .....	219
sitech .....	220
skycomm.....	221
tangent.....	222
therm .....	223
uptime.....	224
user.....	225
Appendix A—Catalogs.....	226
Appendix B—Technical specifications .....	228
Appendix C—Port pin descriptions.....	230
Appendix D—Factors that affect pointing accuracy.....	231
Appendix E—Factors that affect encoder direction senses .....	232
Appendix F—How to replace the lithium coin cell battery.....	233
Appendix G—Troubleshooting guide .....	236
Appendix H—How ARGO NAVIS orders its symbols .....	239
Appendix I—World time zones.....	240
Appendix J—Warranty.....	249
Appendix K—Conformance.....	251
Appendix L—Glossary .....	254
Index.....	<b>Error! Bookmark not defined.</b>



## This manual

This section describes the content of the manual and how to use it.

### Introduction

This manual is divided into 10 main sections:

- How to use this manual
- [The ARGO NAVIS™ interfaces](#)
- [Initial setup of the ARGO NAVIS™](#);
- [Alignment procedures](#)
- [An introductory run](#)
- [Operating modes](#)
- [The ARGONAUT™ software utility](#)
- [Using ARGO NAVIS™ with the ServoCAT Track/GOTO controller](#)
- [Programmer's reference](#)
- [Appendices](#)

### Content of the manual

**The ARGO NAVIS™ interfaces** describes the front panel of the ARGO NAVIS™, including the **DIAL**, the **EXIT** and **ENTER** buttons, and the ports on top of the ARGO NAVIS™.

**Initial setup of the ARGO NAVIS™** describes the once-only requirements for setting-up the ARGO NAVIS™ to suit your mount-type and your individual requirements.

**Alignment procedures** describes how to align ARGO NAVIS™ rapidly for use each night.

**An introductory run** describes how to use the ARGO NAVIS™ to find objects once the initial setup has been performed and ARGO NAVIS™ have been aligned.

**Operating modes** describes the purpose of each mode in the ARGO NAVIS™ firmware and how to use them, and provides examples.

**The ARGONAUT™ software utility** describes the use of the supplied ARGONAUT™ program, which runs on a PC. This software allows you to download to your unit asteroid, comet and satellite orbital elements as well your own user catalogs. You also use ARGONAUT™ to upgrade your ARGO NAVIS™ firmware and in-built catalogs.

The **Using ARGO NAVIS™ with the ServoCAT Track/GOTO controller section** describes how to interface ARGO NAVIS™ with a *ServoCAT* to provide fully motorized operation of your mount.

The **Programmer's reference** is designed for software developers who would like to write applications that can interface with ARGO NAVIS™.

The **Appendices** contain additional information on the ARGO NAVIS™.

### How to use this manual

Don't be daunted by the size of this manual. If you just want to get going, it is suggested that you read:

- [Initial setup of the ARGO NAVIS™](#);
- [Alignment procedures](#) and
- [An introductory run](#)

If you want to know all of the features of the ARGO NAVIS™, it is suggested that you read all of the chapters sequentially.



Don't forget there is a [glossary](#) and an [index](#) if you need it, and the [operating modes](#) are all fully described. If you are reading this manual online as a PDF file, be sure to make use of the hyperlinks and

the Acrobat Bookmarks navigation menu to help find your way around. Watch for updates of this manual at the [Wildcard Innovations](#) web site.



## The ARGO NAVIS interfaces

This section describes the various interfaces of the ARGO NAVIS™.

### Types of interface

The ARGO NAVIS™ has 3 interfaces:

- the user interface;
- the encoder interface;
- the serial interface.

Each type of interface is described below.

### The user interface

The user interface is the front panel and consists of five elements as shown in [Figure 1](#).

- the **ON/OFF** switch;
- the liquid crystal display (**LCD**);
- the **DIAL**;
- the **ENTER** button;
- the **EXIT** button.

The **ON/OFF** switch is located at the top, left-hand of the front panel - **ON** is marked with “I”; **OFF** is marked with “O”.

The **LCD** is the horizontal window located near the top of the front panel. When the power is off the LCD will appear to be a blue colour. When the power is on the display will appear to be a red colour. ARGO NAVIS™ uses a red display because this colour is less likely to impact upon your night vision, which is important when you want to view faint celestial objects. The brightness of the display can also be altered to suit your current viewing conditions (see page [SETUP BRIGHTNESS](#)).

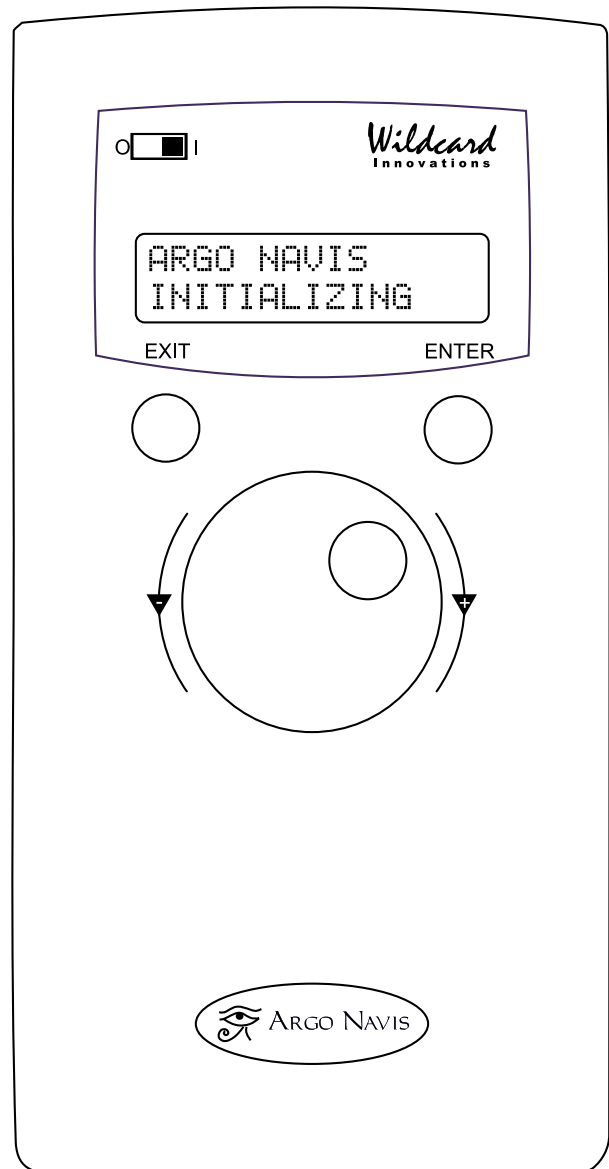

Figure 1 (ARGO NAVIS™ Model 102B shown)



“Firmware” is the term used to describe the software in an electronic appliance. The ARGO NAVIS™ firmware is organized as a set of menus which you can navigate by using the **DIAL** and the **ENTER** and **EXIT** buttons.

The **DIAL** is located in the centre of the front panel. It is used to scroll through the menus, to alter an item within a menu and to manually scroll long text messages. The **DIAL** has what are known as “detent clicks” (see [Glossary](#)). Sometimes you will need to move the **DIAL** one detent “click” at a time.

The **ENTER** button is located on the right-hand side of the front panel. It is used to enter a particular menu you have selected with the **DIAL** and to select a particular item within a menu.

The **EXIT** button is located on the left-hand side of the front panel. It is used to exit from menu selections.

### The encoder interface

The encoder interface is the receptacle

found on top of the unit and marked by the label “ENCODERS”. See [Figure 2](#). If you study your encoder cable, you will find one end has an 8-way RJ-45 plug from which two 4-way cables split. Insert this plug into the encoder interface receptacle.

If you have an encoder cable assembly supplied by [Wildcard Innovations](#), the 4-way cable that has a white sleeve near the encoder end will go to the Altitude axis encoder. The other 4-way cable will go to the Azimuth axis encoder.

The ARGO NAVIS™ Digital Telescope Computer (DTC) encoder interface was designed to be [pin and electrically compatible](#) with that used on the older JMI NGC-MAX™, Celestron Advanced Astromaster™, Lumicom Sky Vector™, SkyComm Engineering Sky Commander™ and similar Digital Setting Circle (DSC) units. Therefore, if you are upgrading to an ARGO NAVIS™ from one of these older units, you can retain your existing encoders and cable. Note, however, that the ARGO NAVIS™ supports a higher encoder sampling rate

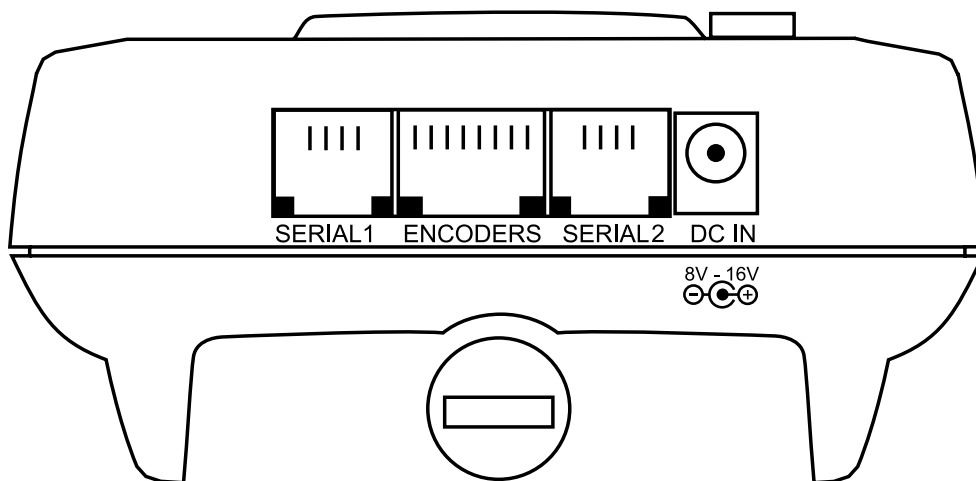

Figure 2 (ARGO NAVIS™ Model 102B shown)



than these older units and therefore will reliably support higher resolution encoders. Though ARGO NAVIS™ will work with lower resolution encoders, [Wildcard Innovations](#) recommends that you consider upgrading to 10,000 step encoders if you would like to achieve potentially finer pointing accuracy.

### The serial interface

ARGO NAVIS™ has two [RS-232](#) serial ports on top of the unit marked **SERIAL1** and **SERIAL2**. See [Figure 2](#). ARGO NAVIS™ can be used completely standalone. However, it is also possible to interface it to a PC, Macintosh™ or Linux computer assuming your PC/Mac has an RS-232 serial port or a USB port.

To interface to a computer with an RS-232 serial port use the ARGO NAVIS™ serial port cable ([Wildcard Innovations](#) Part No. pn-ser-cbl).

If your PC/Mac does not have a RS-232 serial port but is equipped with a USB port, Wildcard Innovations have available a USB to RS-232 Serial Port Adaptor ([Wildcard Innovations](#) Part No. pn-usb) which works in conjunction with the optional RS-232 serial cable (pn-ser-cbl).

By communicating with your PC/Mac, you can perform the following tasks:

- Download firmware & in-built catalog upgrades to the unit. See the page on [Transferring firmware files](#) for details.
- Download asteroid, comet and satellite orbital elements. See the page on [Where to obtain Asteroid, Comet or Satellite Orbital Element Files](#) for details.

- Download your own user objects. See the page on [How to create your own User catalog files](#) for details.
- [Save and restore your ARGO NAVIS™ setups](#).
- Communicate with all known popular star charting, planning & ephemeris programs such as Sky Safari™, Star-Atlas PRO™, The Sky™, SkyMap Pro™, Astroplanner™, Deepsky™, KStars™, Starry Night Pro™, Cartes du Ciel™, SkyTools™, MegaStar™, SkySafari™, Stellarium™, Xephem™, any ASCOM compliant planetarium program and many more, to have a “tracking cursor” display. See the [SETUP SERIAL](#) page for details.

ARGO NAVIS™ can communicate to an Android™ tablet or iPad™ or to a smartphone/iPhone™ by interfacing the ARGO NAVIS™ serial port cable ([Wildcard Innovations](#) Part No. pn-ser-cbl) to third party serial to WiFi adapters such as the Microchip/Roving Networks RN-340 and RN-370 or third party serial to Bluetooth adapters such as the Microchip/Roving Networks RN-270M. It can then be used with apps such as Sky Safari™.

ARGO NAVIS™ serial ports can be interfaced to [ServoCAT™ servo controllers](#), Starmaster Star Tracker™ GOTO controllers and Sidereal Technology SiTech™ GOTO controllers. In each instance, a special serial cable, distinct from the ARGO NAVIS™ serial



ARGO NAVIS™

port cable ([Wildcard Innovations](#) Part No. pn-ser-cbl), needs to be used. Contact Wildcard Innovations for details as to the correct cable to use.

The two serial ports operate completely independently. Their [Baud](#) rates (communications speeds) can be set from the ARGO NAVIS™ front panel. See the [SETUP SERIAL](#) page.

For all operations, except downloading new firmware, either serial port can be used. For [downloading firmware](#), **SERIAL1** is special and is the only port that can be used for this purpose.

**WARNING:** The pin assignment on the ARGO NAVIS™ serial ports is not compatible with those of the SkyComm Engineering Sky Commander™. However, they are compatible with those on the JMI NGC-MAX™, Celestron Advanced Astromaster™, Lumicom Sky Vector™ and similar Digital Setting Circle (DSC) units. (See [Port pin descriptions](#)). To avoid possible damage to your ARGO NAVIS™ or PC, we recommend you use only a genuine ARGO NAVIS™ optional serial interface cable ([Wildcard Innovations](#) Part No. pn-ser-cbl).

**WARNING:** When interfacing your ARGO NAVIS™ to a PC, you should be aware of the possibility of electrostatic discharge that could result in damage to your ARGO NAVIS™, PC and associated peripherals. Be sure to ground yourself adequately prior to interfacing any two pieces of

equipment. Be particularly careful in static prone environments, especially in low humidity conditions or while walking on carpets. Wildcard Innovations bears no liability for loss or damage caused to your equipment from static discharge.

**WARNING:** It is your responsibility to ensure that any cables connected to your ARGO NAVIS™ do not pose a hazard to yourself and others. Ensure that it is not possible for yourself or others to trip over your cabling. You should be aware that cabling could be a hazard to persons especially at night-time and when outdoors. Wildcard Innovations bears no liability for loss, damage or injury caused by persons tripping over your cabling.



ARGO NAVIS™

## Initial setup of the ARGO NAVIS

This section describes the once-only requirements for setting-up the ARGO NAVIS™ to suit your scope and your individual requirements. This includes:

- setting up the power sources;
- setting your initial mount type;
- setting your encoder resolution;
- setting your encoder senses;
- setting your final mount type;
- setting the local time zone, date and time;
- setting your location;
- enabling refraction modelling;

### Power sources

There are two types of power source:

- internal battery power; and,
- external battery power.

#### Internal Battery Power

4 “AA”, 1.5V batteries provide the internal battery power. These should be alkaline, lithium or rechargeable NiMH batteries. Since NiMH batteries have reduced capacity below 20C (68F), their use is not recommended in cool or cold climates. Do not use NiCd or regular/heavy-duty zinc-oxide batteries.

To install batteries, refer to [Figure 3](#). Using a coin, remove & retain the battery

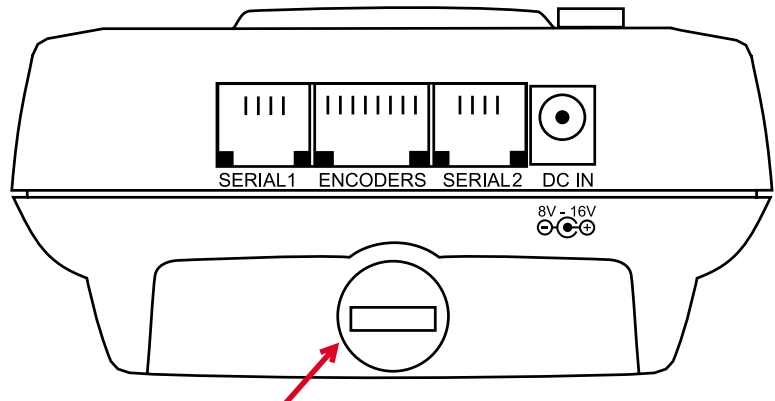

Battery hatch thumbscrew

**Figure 3 (ARGO NAVIS™ Model 102B shown)**

hatch thumbscrew on the battery housing (the raised section at the top of the back) of the ARGO NAVIS™. Gently slide the battery cover slightly toward the top of the unit by about 1cm and then lift it off.

To place the batteries in, refer to [Figure 4](#). Observe the polarity indicators inside the battery housing (+ on the battery should be placed at the same end as the + on the markings inside the battery housing). Replace the battery hatch cover and thumbscrew.

- Ensure batteries are removed from the ARGO NAVIS™ if it is to be stored or not used for prolonged periods in case of battery leakage.
- Do not charge rechargeable batteries whilst in battery housing.



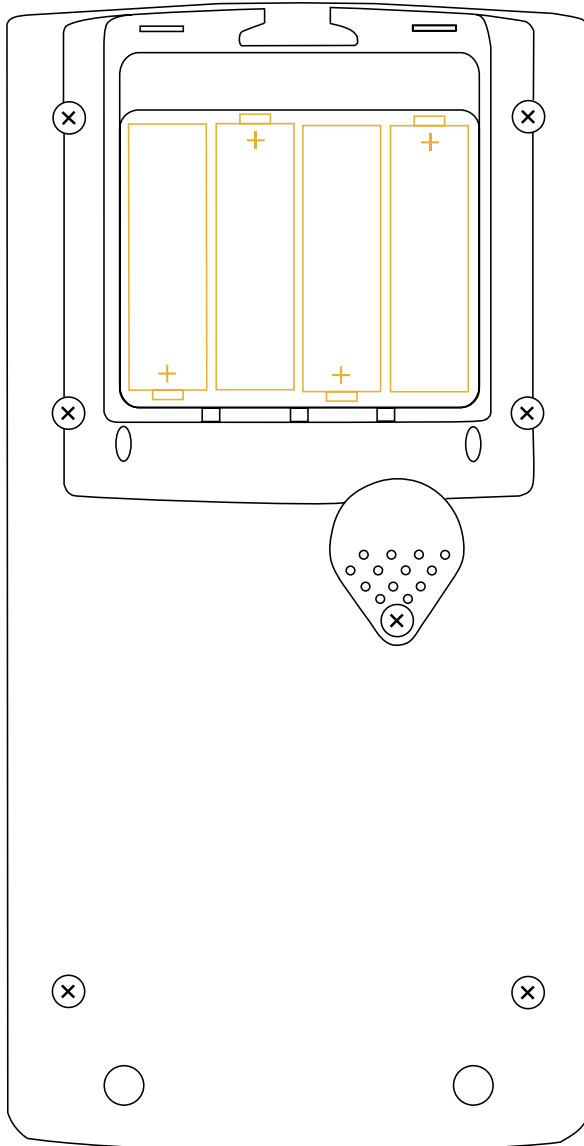

Figure 4 (ARGO NAVIS™ Model 102B shown)

- Do not connect any other form of power supply to battery terminals.  
Fresh alkaline batteries with the display fully dimmed can provide from 12 to 40 hours usage of the unit depending on several additional factors including what type of encoders are installed.

### External battery power

The optional external DC power cable allows you the convenience to power the ARGO NAVIS™ from an external battery source such as a 12V car battery. The external power receptacle is [found on the top](#) of the unit and is marked DC IN. The external battery voltage should be in the range of 8V to 16V DC. An incorrect power voltage source or polarity could cause damage to your unit and void your warranty. Use only the optional external DC power cable supplied by [Wildcard Innovations](#) (Part No. pn-pwr-cbl) for supplying external power to your unit. Though ARGO NAVIS™ provides in-built reverse polarity and short circuit protection, the optional cable contains a 350mA fuse for additional safety.

**WARNING:** Never use a cable with an incorrect fuse (we recommend 315mA) and never bypass the fuse protection. Observe all safety procedures when working with external batteries. Many contain dangerous acids that can be spilt and some batteries are capable of delivering very large currents that can destroy equipment or cause a fire if they are short-circuited.

**WARNING:** Be careful not to trip or allow others to trip over the external power cable or any other cables from your unit.

## Setting the initial mount type

ARGO NAVIS™ requires you to specify what style of mount your telescope is on.

**However, for the purpose of this once-only initial setup procedure, you will be asked to set your mount type to the FORK EXACT ALIGN setting, irrespective of what type of mount you really have.**

**Later, you will be asked to set the mount type to match the type of mount you are using.**

Power the unit on. Turn the **DIAL** clockwise until you see -

**MODE SETUP**

Press **ENTER**. Now turn the **DIAL** clockwise until you see -

**SETUP MOUNT**

Notice how ARGO NAVIS™ orders its various menus alphabetically so you can find a particular one logically and quickly.

Now press **ENTER**. The display might then show -

**ALTAZ/DOBSONIAN**

where the whole line will be flashing. Spin the **DIAL** until the display shows -

**FORK EXACT ALIGN**

Then press **EXIT** or **ENTER**. ARGO NAVIS™ will briefly display the words

**SAVING ...**

while it saves your settings into its memory (EEROM device) and then display the message -

**SETUP MOUNT**

## Setting encoder steps (resolution)

Before you can perform an alignment, you need to set up in ARGO NAVIS™ the resolution and “direction senses” of your altitude and azimuth encoders.

### Encoder operation background

Most optical encoders will have a printed label specifying either their part number or their resolution. For example, if you have an encoder marked with the part number S2-2500, this is a 10,000-step encoder (10,000 is 4 times 2500 - this style of encoder is technically known as a Quadrature Encoder).

When an encoder rotates, it transmits electrical pulses or ‘steps’. A 10,000-step encoder will produce 10,000 steps when it is rotated 360°. Therefore, one ‘step’ on such an encoder corresponds to an angle of rotation of about 2.16 arc minutes.

Encoders can be geared to produce a higher or lower number of ‘steps’ when the telescope mount bearing they are attached to rotates through 360°.

In any case, you need to establish how many steps your encoders produce when the bearing they are attached to is rotated through 360°. In many cases, bearings, particularly altitude (declination) bearings, may be incapable of being rotated through a full 360°. Nonetheless, you will still need to establish how many steps the encoder





would produce if the bearing could be rotated through a full 360°.

If the shaft of your encoder is attached directly to the axis of rotation of the bearing and is not geared, then the number of steps for that particular encoder is simply its rated number of steps.

### Setting altitude steps

Having established how many steps each encoder is, spin the **DIAL** within the **SETUP** menu-level until you see -

**SETUP ALT STEPS**

Press **ENTER** and the display might show something like this -

**ALT=+0010000**

where the '+' sign will be flashing. Leave the sign as a '+' for now and press **ENTER** and edit the fields as need be by using the **DIAL** to change a value and **ENTER** to advance to the next field. When the correct number of steps is displayed, press either **ENTER** or **EXIT** and if the value has changed from what it originally was, **ARGO NAVIS™** will briefly display the words -

**SAVING ...**

while it saves your settings into its memory (EEROM device) and then display the message -

**SETUP ALT STEPS**

You have now set your altitude encoder step setting. However, as will be explained later, you may need to come

back and change the encoder 'direction sense' (the '+' sign or '-' sign) depending upon your circumstances.

### Setting azimuth steps

Using the **DIAL**, go to -

**SETUP AZ STEPS**

Press **ENTER** again and the display might show something like this -

**AZ=+0010000**

where the '+' sign will be flashing. Leave the sign as a '+' for now and press **ENTER** and edit the fields as need be by using the **DIAL** to change a value and **ENTER** to advance to the next field. When the correct number of steps is displayed, press either **ENTER** or **EXIT** and if the value has changed from what it originally was, **ARGO NAVIS™** will briefly display the words -

**SAVING ...**

while it saves your settings into its memory (EEROM device) and then display the message -

**SETUP AZ STEPS**

You have now set your azimuth encoder step setting. However, as will be explained later, you may need to come back and change the encoder 'direction sense' (the '+' sign or '-' sign) depending upon your circumstances.



**ARGO NAVIS™**

## Testing encoder communication

Power ARGO NAVIS™ off. Make sure that your encoders are installed on your mount and that your encoder cable is connected both to them and into the **ENCODERS** port of the ARGO NAVIS™. (See [Figure 2](#).)

Power ARGO NAVIS™ on and use the **DIAL** to go to -

### MODE ENCODER

Press **ENTER**. The display should show something like this -

```
AZ/ALT ENC ANGLE  
000.00° +000.00°
```

The display is showing the angle of the azimuth encoder on the bottom left of the display and that of the altitude encoder on the bottom right.

Move the scope in azimuth (Right Ascension). Make sure that the AZ angle on the display changes. Now move the scope in altitude (Declination). Make sure that the ALT angle changes. If the ALT reading changes when you move the scope in azimuth and vice versa, you have the encoder cables swapped around. On most encoder cables supplied by [Wildcard Innovations](#), the cable that has the white sleeve near its encoder end should go to the altitude encoder.

If neither or only one angle changes on the display check that the connections to the encoders are correct, in particular making sure that the plug that connects to the encoder pin header is inserted the right way up. On encoders and cables supplied by [Wildcard Innovations](#), the

correct orientation can be ascertained by matching the small circular sticker on the plug with the same type of sticker on top of the encoder (the side opposite that from which the shaft protrudes). Also, ensure that any set-screw holding the encoder shaft in place is firm and is not allowing the encoder shaft to slip. Finally, check the batteries in your ARGO NAVIS™ and replace them if necessary.

If you are performing the above test without having installed the encoders on your mount and you are simply turning the encoder shafts with your fingers, you may see one of the following messages on the display -

- AZ ENCODER ERROR
- ALT ENCODER ERR
- BOTH ENCODER ERR

This simply means that you have turned the encoders too quickly and have exceeded their sampling rate, thus missing counts. ARGO NAVIS™ typically samples the encoders at a very high rate (much higher than older Digital Setting Circle, or 'DSC', units) and when the encoders are installed on your mount, you should not see these errors during normal operation. If the encoders are installed on your mount and you do see these errors, check the batteries in ARGO NAVIS™ and the connections on your encoders. Otherwise see the [Troubleshooting guide](#).

Once you have established that your ARGO NAVIS™ can reliably communicate with your encoders, you are ready to proceed.





## Determining encoder direction senses

When you were initially setting your encoder resolution with [SETUP ALT STEPS](#) and [SETUP AZ STEPS](#), you were asked to ignore the flashing '+' sign. Using the **DIAL**, the sign can be made to be either a '+' or a '-'. It determines the way that ARGO NAVIS™ interprets the 'direction sense' of the applicable encoder.

Setting the correct direction senses of your encoders is very important. Many [factors influence the setting of encoder direction senses](#). For example, in the case of an altitude encoder, whether it is mounted on the left or right-hand side of the mount and whether it has been geared an even or odd number of times are just two of the factors. The section named Factors affecting encoder direction sense details these. For this reason, determining the correct direction senses of your encoders may not be simply intuitive. Fortunately, you can perform a test with your scope that will tell you what the correct senses are. Once you have patiently worked through the test and have determined the correct settings for the encoders on your mount, you should never need to change them again.

To determine the direction senses of your encoders, follow these instructions.

Power off your ARGO NAVIS™, and then power it back on. After it initializes, you should see –

**MODE ALIGN STAR**

then press **ENTER**. The display should show something like -

**ALIGN ACHERNAR**

If your scope is on a Fork Mount, roughly polar align it. Orient the tube so that it is the "way-up" you normally observe, thus –

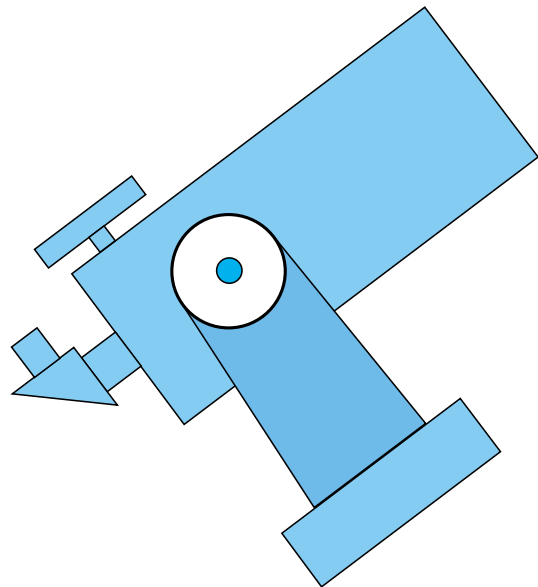

Fork tube oriented "normal" way up.

**Figure 5**

If your scope is on a German Equatorial Mount (GEM), roughly polar align it. If you are in the Northern Hemisphere, place the tube on the West side of the mount. If you are in the Southern Hemisphere, place the tube on the East side of the mount.

If your scope is on an Alt/Az Mount, such as a Dobsonian, just continue reading. If your Alt/Az mount is mounted on top of an equatorial table, accurately polar align the table, move the table to the start position and switch it off for now.



**ARGO NAVIS™**

Look up at the sky and pick a familiar bright star not far from the Celestial Equator (the imaginary line in the sky where Declination = 0°.) Spin the **DIAL** and look for that star's name. There are 35 to choose from. The [MODE ALIGN STAR](#) reference page lists the alignment stars. If you cannot find the star you have chosen in the list, pick another that is in the list that is not too far from the Celestial Equator. For example, say you have chosen Sirius. Spin the **DIAL** until you see -

**ALIGN SIRIUS**

Centre Sirius in the eyepiece, then press **ENTER**. The display will briefly show something like this –

**ALIGN SIRIUS**  
**WARP= +0.00**

Now press **EXIT** and spin the **DIAL** until the display shows –

**MODE RA DEC**

then press **ENTER**. The display should show the approximate Right Ascension and Declination of the last star you aligned on. In the example of Sirius, the display might show something like this -

**06:45.3 -16°43'**  
**CANIS MAJOR**

While watching the RA reading on the display, rotate the scope slowly in an Easterly direction. The RA value should increase. If instead it decreases, take note of that fact and continue for now.

While watching the Dec reading on the display, rotate the scope slowly in a Northerly direction. The Dec value should increase (a negative Dec value that becomes more and more negative is in fact decreasing). If the Dec value is decreasing, take note of that fact and continue.

If the Right Ascension and Declination directions were consistent with the above procedure, you do not need to alter the **SETUP ALT STEPS** or **SETUP AZ STEPS** direction senses.

If the Right Ascension reading decreased as the scope was moved towards the East, then go back to **SETUP AZ STEPS** and change the direction sense sign.

If the Declination reading decreased as the scope was moved towards the North, then go back to **SETUP ALT STEPS** and change the direction sense sign.

If you changed either or both signs, power the unit off and then on and repeat the procedure to verify that the new encoder direction senses are correct.

### Setting the final mount type

During the initial once-only setup procedure, you were asked to set the mount type to **FORK EXACT ALIGN**. You will now need to set your mount type to match your actual mount. If you have a Fork mount that is exactly polar aligned, you obviously do not need to change the setting.

Otherwise, power the unit off, then on. Turn the **DIAL** clockwise until you see -

**MODE SETUP**



Press **ENTER**. Now turn the **DIAL** clockwise until you see -

**SETUP MOUNT**

Now press **ENTER**. The display should show -

**FORK EXACT ALIGN**

where the whole line will be flashing. Spin the **DIAL** and select your mount type. The various mount types are tabled below.

Once you have selected your mount type, press either **EXIT** or **ENTER**. **ARGO NAVIS™** will briefly display the words

**SAVING ...**

while it saves your settings into its memory (EEROM device) and then display the message –

**SETUP MOUNT**

Menu selection	When to use	Number of alignment stars required
<b>ALTAZ/DOBSONIAN</b>	For altitude/azimuth mounts such as Dobsonians (but not on equatorial tables);	<a href="#">FIX ALT REF</a> step plus 2 <a href="#">alignment stars</a>
<b>EQ TABLE EXACT</b>	For altitude/azimuth mounts mounted on top of an accurately polar aligned equatorial table	<a href="#">FIX ALT REF</a> step plus 2 <a href="#">alignment stars</a>
<b>FORK EXACT ALIGNED</b>	For any accurately aligned equatorial mount, such as a fork mount, but not a German equatorial or an equatorial table.	One <a href="#">alignment star</a>
<b>FORK ROUGH ALIGN</b>	For any roughly aligned equatorial mount, such as a fork mount, but not a German equatorial or an equatorial table.	<a href="#">FIX ALT REF</a> step plus 2 <a href="#">alignment stars</a>
<b>GEM EXACT ALIGN</b>	For an accurately polar aligned German equatorial.	One <a href="#">alignment star</a>
<b>GEM ROUGH ALIGN</b>	For a roughly aligned German equatorial.	<a href="#">FIX ALT REF</a> step plus 2 <a href="#">alignment stars</a>



**ARGO NAVIS™**

## Setting the local time zone, date and time

ARGO NAVIS™ contains an in-built battery-backed time of day clock. An internal lithium coin cell battery powers the clock even when the power is switched off or the main batteries are removed.

Though ARGO NAVIS™ does not require you to set the time or your location to operate, doing so provides the following additional features and benefits:

- The local time and date, the UTC (Greenwich) time and date and the current Julian date (see [Glossary](#)) will be available to you from the [MODE TIME](#) menu.
- The Local Apparent Sidereal Time (LAST) will be available to you in [MODE SIDEREAL](#) if you have also specified your location.
- The topocentric azimuth and altitude (see [Glossary](#)) will be available to you in [MODE AZ ALT](#) assuming you have also specified your location and have performed a valid star alignment.
- The HORIZON MASK filtering option will be applied correctly in [MODE IDENTIFY](#) and [MODE TOUR](#) assuming that you have also specified your location.
- If in [SETUP GUIDE MODE](#) the GUIDE BELOW HORZ setting has been set TO H INDICATOR ON, then an 'H' symbol will appear on the GUIDE mode display whenever an object is computed to be below the computed horizon, which in turn

also assumes that you have specified your location.

- Correction for atmospheric refraction (see [Glossary](#)) will be made while you point your scope assuming you have also specified your location and assuming you have turned refraction correction ON in the [SETUP REFRACTION](#) sub-menu.
- Objects will be precessed and nutated (see [Glossary](#)) from their internally stored J2000.0 epoch positions to their actual position at the time you observe them.
- The positions of planets can be accurately determined.
- The positions of asteroids and comets can be computed from their orbital elements.
- The position of earth orbiting satellites can be computed assuming you have also specified your location.
- If you have a *ServoCAT*™ slew and track system, ARGO NAVIS™ will provide horizon limit checking when running the "[servocat](#)" [STARTUP](#) command on the ARGO NAVIS™ serial port. Horizon limit checking also assumes you have specified your location.

For these reasons it is worthwhile setting your local time zone, date and time. Since ARGO NAVIS™ retains the time even when it is powered off, you only need do it once and then possibly occasionally to correct for normal clock drift.



ARGO NAVIS™

To set the local time zone, date and time, perform the following. Power the unit on. Turn the **DIAL** clockwise until you see

**MODE SETUP**

Press **ENTER**. Now turn the **DIAL** clockwise until you see

**SETUP DATE/TIME**

Notice how **ARGO NAVIS™** orders its various menus alphabetically so you can find a particular one logically and quickly.

Press **ENTER**. **ARGO NAVIS™** will display something like

**TIMEZONE=+00:00**

Where the '+' (or possibly '-') sign will be flashing.

To understand the concept of time zone, it is important to know that **ARGO NAVIS™** always internally keeps track of time in terms of Universal Co-ordinated Time (UTC), which was previously referred to as Greenwich Mean Time (GMT). The time zone is the number of hours that your local time differs from UTC. For example, in New York when Daylight Savings Time (Summer time) is not in effect, the time zone setting is -05:00 hours. When Daylight Savings (summer time) is in effect, the time zone is -4:00. In Sydney, when Daylight Savings time is not in effect, the time zone setting is +10:00 hours and when Daylight Savings is in effect +11:00. In New Delhi the time zone is +05:30.

Use the [World timezones](#) section of this manual to determine your local time zone. If you are in a time zone that is west of Greenwich, you will set the sign to a '-'. If you are in a time zone that is east of Greenwich, you will set the sign to a '+'.

By turning the **DIAL** you can change the sign alternately between a '+' and a '-'. When you have selected the correct sign, hit **ENTER**, which advances the flashing 'cursor' to the first numeric field. You can change the value in that field by turning the **DIAL**. When you have selected the correct value, advance the cursor to the right by hitting the **ENTER** button again and so on. When you have finished editing the last field (most people will live in a time zone that is only a whole number of hours offset from UTC), pressing the **ENTER** button again will result in a display something like

**DATE=24 APR 2015**  
**TIME=15:30:45**

where the first digit will be flashing. Again, as in editing the time zone, edit the correct local date and time by using the **DIAL** and pressing the **ENTER** button to advance over fields. If you make a mistake, press **EXIT** and start over again. Keep in mind that you are entering your local date and time here, not the UTC time. **ARGO NAVIS™** will perform the appropriate arithmetic to convert the date and time you enter to internal UTC time by taking into account the time zone you entered.

When you have edited the last field, you may like to synchronize the pressing of the **ENTER** button against some



correct time reference. ARGO NAVIS™ will then briefly display the words

**SAVING ...**

and then the words

**INITIALIZING ...**

in the lower half of the display before returning to the SETUP sub-menu with the message

**SETUP DATE/TIME**

You have now successfully set your local time zone and your local date and time.

While the **SAVING...** message appeared, ARGO NAVIS™ saved your time zone setting into its memory (EEROM device) and the date and time into the battery backed time-of-day clock. While the **INITIALIZING ...** message appeared, ARGO NAVIS™ re-initialized such things as the positions of planets, asteroids and comets and recalculated the amount of precession and nutation to account for since the [J2000.0 epoch](#).

It is handy to remember that whenever Daylight Savings comes into or out of force in your locality, simply edit the time zone by adding or subtracting an hour from it as necessary. There is no need to change the local time as changing the time zone will automatically perform the correct arithmetic.

Normally the lithium coin cell battery used by the time of day clock should last for several years. If for any reason it should run flat, when ARGO NAVIS™ is powered on, it will display briefly this message

**RTC BATTERY FLAT**

Followed by this message -

**SETTING DATE TO  
12:00 1 JAN 2000**

See the section [How to replace the lithium coin cell battery](#) for details.

## Setting the location

As was discussed in the section on setting the time zone, date and time, ARGO NAVIS™ does not require you to set your location to operate, however, doing so brings about other features and benefits.

While in [MODE SETUP](#), turn the **DIAL** until you see -

**SETUP LOCATION**

Then press **ENTER**, where you will then see a location name such as this

**NOWHERE, ATLANTIC**

If you turn the **DIAL** you will then see the names of 10 locations in the world. If you happen to live in one of them, simply hit **EXIT** while its name appears in the display and you are done.

Chances are, however, that you do not live in any of the locations indicated. This is not a problem, since you can edit the locations to places that you observe from. For example, say you are unlikely to do any observing from Mawson Base in Antarctica. Let us edit the 'MAWSON BASE' location to 'HOME'.



ARGO NAVIS™



While in [SETUP LOCATION](#), Turn the **DIAL** until

**MAWSON BASE**

appears on the display The whole line will be flashing.

Now press the **ENTER** button. You have now entered location name edit mode. The 'M' character will be flashing indicating that the cursor is at that location. Turn the **DIAL** anti-clockwise until the letter 'H' appears, then press **ENTER** to advance to the next letter, which is an 'A'. Turn the **DIAL** in either direction to make it a 'O', press **ENTER**, and so on until you have spelt out the word 'HOME'. Continue to erase the rest of the characters in the old MAWSON BASE name by turning them into SPACES. The SPACE character is found just after the letter 'Z' if you are turning the **DIAL** clockwise. When you have erased the last character, press **ENTER** multiple times until the display shows this

**LAT=67:35:59 S**

This is the latitude of Mawson Base which you will now change to your local latitude. To determine your local latitude, consult an atlas or one of the many location databases (such as [www.heavens-above.com](http://www.heavens-above.com)) available on the Internet. Unless you plan on observing satellites, or accurately knowing your Local Apparent Sidereal Time (LAST), don't be too concerned if you cannot determine the exact co-ordinates of your location. Within a degree or so should be fine for most situations.

Using the **DIAL** and **ENTER** button, edit the latitude fields to values appropriate for your observing location. Latitude is displayed in terms of degrees:minutes:seconds either North or South of the Earth's equator. Change the 'S' to an 'N' depending upon whether your location is in the Northern or Southern Hemisphere.

After editing the North/South field, pressing **ENTER** again will result in the display showing this

**LONG=062:53:00 W**

This is the longitude of Mawson Base. Edit it as you did the Latitude, replacing the fields with values appropriate to your observing location. Longitude is displayed in terms of degrees:minutes:seconds either East or West of Greenwich. Change the 'W' to an 'E' depending upon whether your location is East or West of the Greenwich Meridian. For example, if you live in the United States or Canada, your location will be West of Greenwich so you will enter a 'W'. If you live in Australia, for example, your location will be East of Greenwich so you will enter an 'E'.

When you have edited the last longitude field, press **ENTER**. The display will then show

**HOME**

where the word HOME will be flashing. Press **EXIT** to set HOME as your observing location. The display will briefly show

**SAVING ...**

And then the words



ARGO NAVIS™

### INITIALIZING ...

In the lower half of the display before returning to the SETUP sub-menu with the message

### SETUP LOCATION

You have now successfully set your location.

While the **SAVING...** message appeared, ARGO NAVIS™ saved your location settings into its memory (EEROM device). While the **INITIALIZING ...** message appeared, ARGO NAVIS™ re-initialized such things as the current Local Apparent Sidereal Time (LAST).

You can edit as many of the locations in the SETUP LOCATION menu as you desire. Whenever you change observing location, simply enter the SETUP LOCATION menu, turn the **DIAL** until the name of the location you are observing from appears, then hit **EXIT**.

Remember, in order to perform an alignment and to use most of the features of ARGO NAVIS™ you don't need to set your time zone, date, time or location unless you also decide to turn on refraction modelling correction or would like some of the other features or benefits discussed earlier.

### Setting refraction modelling

Due to the phenomenon of atmospheric refraction, celestial objects close to an observer's horizon will appear to be higher in altitude than what they actually are. ARGO NAVIS™ can compensate for the effects of atmospheric

refraction. However, to do so, ARGO NAVIS™ must have had the time zone, date, time and location set reasonably accurately. It uses these parameters in conjunction with information it will obtain once you perform an alignment, to determine where the observer's local horizon is. Having determined that, it then can correct for refraction.

If you do not plan to observe objects close to the horizon, you may decide to leave refraction modelling off. However, if you are confident you have set your time zone, date, time and location correctly, it is a good idea to turn it on to improve your pointing accuracy.

To turn refraction modelling on, go to the

### SETUP REFRACTION

sub-menu and press **ENTER**. The display might then show -

**REFRACTION=OFF**

where the word '**OFF**' is flashing. Use the **DIAL** to change the setting to either '**ON**' or '**OFF**' as you desire. Then press either **EXIT** or **ENTER** to save that selection into memory (EEROM device) and to specify it as your current setting.



ARGO NAVIS™



## Alignment procedures

This section gives a quick introduction to the alignment procedure for ARGO NAVIS™. Variations and possible refinements to the alignment procedure are discussed in -

[MODE FIX ALT REF](#)

[SETUP ALT REF](#)

[MODE ALIGN STAR](#)

[MODE ALIGN](#)

[MODE EQ TABLE](#)

[SETUP ALIGN PICK](#)

[SETUP REFRACTION](#)

and

[SETUP MNT ERRORS.](#)

After reading this section, you are encouraged to read the sections just referenced to provide you with a fuller understanding of the alignment procedure. They are worth reading as the alignment procedures described here are simply meant to help you get started. A fuller understanding of the alignment procedure will help you improve your pointing accuracy.

### Purpose of alignment

Whenever you power on ARGO NAVIS™ you will need to carry out an alignment procedure in order for it to locate objects.

The alignment procedure depends on the type of mount you have and whether it is accurately polar-aligned or not. You should have already set your mount type in [SETUP MOUNT](#).

### Fork Exact Align and German Equatorial Exact Align Mounts

The possible polar-aligned mount settings are FORK EXACT ALIGN and GEM EXACT ALIGN (for German Equatorials). The following procedure assumes that the mount has been accurately polar-aligned. If that is so, only one alignment star is required.

When ARGO NAVIS™ is first powered on, after initializing, it will prompt you with -

**MODE ALIGN STAR**

Press **ENTER**. The display should show something like -

**ALIGN ACHERNAR**

If you have a German Equatorial Mount, and are in the Northern Hemisphere, position the tube on the West side of the mount.

If you have a German Equatorial Mount and are in the Southern Hemisphere, position the tube on the East side of the mount.

If you have a Fork mounted scope, orient the tube the “normal” way up that you observe with it.

Look up at the sky and pick a familiar bright star. Spin the **DIAL** and look for that star’s name. There are 35 to choose from. The [MODE ALIGN STAR](#) reference page lists the alignment stars. If you cannot find the



star you have chosen in the list, pick another that is in the list.

Sight the star. If you have a German Equatorial mount and would like to sight the star with the tube on the opposite side of the mount, go to SETUP ALT STEPS and change the direction sense sign.

Whenever you wish to re-align using the scope on the original side of the mount, be sure to change the sign back.

Centre the star as accurately as possible in the centre of the eyepiece, not just the finder-scope. When the star is perfectly centred, press **ENTER**. For example, say you have chosen Sirius. The display will briefly show –

ALIGN SIRIUS  
WARP= +0.00

This completes the alignment procedure. Now go on to read [An introductory run](#).

### Alt/Az Dobsonian Mounts including on Equatorial Tables

If you have set your mount type to be ALT/AZ DOBSONIAN or EQ TABLE EXACT then use the following procedure. You will be required to perform an operation called [FIX ALT REF](#) and two star alignments.

If you are using an equatorial table, park the table to its start position and switch it off for now.

When ARGO NAVIS™ is first powered on, after initializing, it will prompt you with –

FIX ALT REF

Press **ENTER**. Turn the **DIAL** until you see -

ALT REF=90°  
AUTO ADJUST OFF

Now move your telescope to a position in

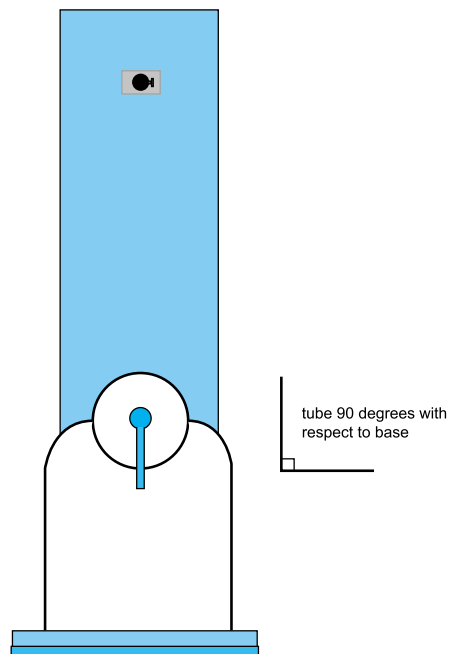

Figure 6

altitude so that the tube is pointing at right angles with respect to the base like thus-

The scope does not have to be level on the ground. Only the orientation of the tube to the base is important. If the telescope is sitting on an equatorial table, it is the orientation of the tube to the plane of the table that is important. Due to mechanical constraints in your mount, you may not be able to get the scope at exactly right angles. Try to get it as close as possible for now. Later on you can

review the [MODE FIX ALT REF](#) reference page that discusses the AUTO ADJUST ON feature that can assist you with this procedure. It's worth reading as this is a very important step that can dramatically improve your pointing accuracy.

When your tube is in this position, press **ENTER**. The display will briefly show -

ALT REF=90°  
WARP=ALT FIX OK

Press **EXIT**. In the top-level menu, spin the **DIAL** until you see -

MODE ALIGN STAR

then press **ENTER**. The display should show something like -

ALIGN ACHERNAR

Look up at the sky and pick a familiar bright star. Spin the **DIAL** and look for that star's name. There are 35 to choose from. Section [MODE ALIGN STAR](#) lists the alignment stars. If you cannot find the star you have chosen in the list, pick another that is in the list. For example, say you have chosen Sirius. Spin the **DIAL** until you see -

ALIGN SIRIUS

Centre Sirius in the eyepiece, then press **ENTER**. The display will briefly show something like this -

ALIGN SIRIUS  
WARP= -4.75 (1)

Your "WARP" number will probably be different, but don't worry. Now pick a

second bright alignment star. Preferably choose one approximately 30° to 90° away from the first and which will involve having to move the scope in both axes. For example, say you have chosen Capella. Spin the **DIAL** until you see -

ALIGN CAPELLA

Centre Capella in the eyepiece, then press **ENTER**. The display will briefly show something like this -

ALIGN CAPELLA  
WARP= +0.12

Your "WARP" number should ideally be as close to 0.00 as possible. A number in the range of -0.5 to +0.5 will probably give you reasonable pointing accuracy depending upon the accuracy of your initial FIX ALT REF step and how far you move from the initial alignment stars.

If your WARP number was much larger you may want to check that you identified the correct stars and repeat the alignment procedure if need be. Otherwise see the [Troubleshooting guide](#).

Only if you are using an equatorial table and you have set your mount type to be EQ TABLE EXACT, then perform the following steps to begin tracking -

Press **EXIT** to go to the top-level menu and then spin the **DIAL** until you see -

MODE EQ TABLE

then press **ENTER**. The display should show this -

EQ TBL ELAPSED  
00:00:00.0 STOP



ARGO NAVIS™

Simultaneously start the table and press **ENTER** which will start the ARGO NAVIS™ equatorial table timer. Refer to the section entitled [MODE EQ TABLE](#) in order to learn more about how to successfully use your ARGO NAVIS™ with an equatorial table.

This completes the alignment procedure. Be sure to take the time to read the section on [MODE FIX ALT REF](#). In particular you may want to come back and attempt to use the AUTO ADJUST ON mode. It may well dramatically improve your alignment. Now go on to read [An introductory run](#).

### Fork Rough Align Mounts

Sometimes you may not want to align your Fork mount accurately but would still like to find objects. If you have set your mount type to be FORK ROUGH ALIGN, then use the following procedure. You will be required to perform an operation called [FIX ALT REF](#) and two star alignments.

When ARGO NAVIS™ is first powered on, after initializing, it will prompt you with –

**FIX ALT REF**

Press **ENTER**. Turn the **DIAL** until you see –

**ALT REF=0°  
AUTO ADJUST OFF**

Roughly polar align your scope. Orient the tube as accurately as possible so that it is 90° with respect to the forks and the “way-up” you normally observe, thus –

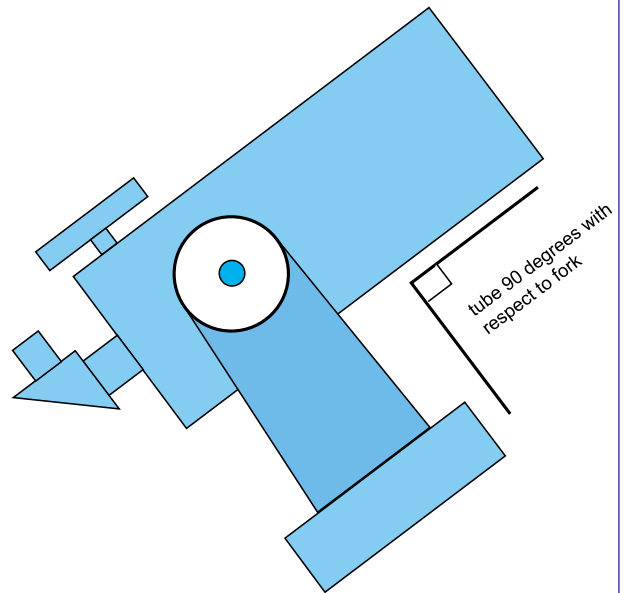

**Figure 7**

When your tube is in this position, press **ENTER**. The display will briefly show –

**ALT REF=0°  
WARP=ALT FIX OK**

Press **EXIT**. In the top-level menu, spin the **DIAL** until you see –

**MODE ALIGN STAR**

then press **ENTER**. The display should show something like –

**ALIGN ACHERNAR**

Look up at the sky and pick a familiar bright star. Spin the **DIAL** and look for that star's name. There are 35 to choose from. The [MODE ALIGN STAR](#) reference page lists the alignment stars. If you cannot find the star you have chosen in the list, pick

another that is in the list. For example, say you have chosen Sirius. Spin the **DIAL** until you see -

**ALIGN SIRIUS**

Centre Sirius in the eyepiece, then press **ENTER**. The display will briefly show something like this -

**ALIGN SIRIUS**  
**WARP= -1.75 (1)**

Your "WARP" number will probably be different, but don't worry. Now pick a second bright alignment star. Preferably choose one approximately 30° to 90° away from the first and which will involve having to move the scope in both axes. For example, say you have chosen Capella. Spin the **DIAL** until you see -

**ALIGN CAPELLA**

Centre Capella in the eyepiece, then press **ENTER**. The display will briefly show something like this -

**ALIGN CAPELLA**  
**WARP= +0.20**

Your "WARP" number should ideally be as close to 0.00 as possible. A number in the range of -0.5 to +0.5 will probably give you reasonable pointing accuracy depending upon the accuracy of your initial FIX ALT REF step.

If your WARP number was much larger you may want to check that you identified the correct stars and repeat the alignment procedure if need be. Otherwise see the [Troubleshooting guide](#).

This completes the alignment procedure. Be sure to take the time to read the section on [MODE FIX ALT REF](#). In particular you may want to come back and attempt to use the AUTO ADJUST ON mode. It may well dramatically improve your alignment. Now go on to read [An introductory run](#).

## GEM Rough Align

Sometimes you may not want to align your German Equatorial Mount accurately but would still like to find objects. If you have set your mount type to be GEM ROUGH ALIGN, then use the following procedure. You will be required to perform an operation called [FIX ALT REF](#) and two star alignments.

When ARGO NAVIS™ is first powered on, after initializing, it will prompt you with -

**FIX ALT REF**

Press **ENTER**. Turn the **DIAL** until you see -

**ALT REF=0°**  
**AUTO ADJUST OFF**

Roughly polar align your scope.

If you are in the Northern Hemisphere, place the tube on the West side of the mount.

If you are in the Southern Hemisphere, place the tube on the East side of the mount.

If you are going to do the first star alignment with the tube on the opposite side of the mount, go to SETUP ALT STEPS



ARGO NAVIS™

and change the direction sense sign. Be sure to change it back when you want to do a first-star alignment on the original side of the mount.

Set the tube so that the scope's Optical Axis is at 90° with respect to the Polar Axis. Try to do this as accurately as possible.

When your tube is in this position, press **ENTER**. The display will briefly show -

```
ALT REF=0°  
WARP=ALT FIX OK
```

Press **EXIT**. In the top-level menu, spin the **DIAL** until you see -

```
MODE ALIGN STAR
```

then press **ENTER**. The display should show something like -

```
ALIGN ACHERNAR
```

Look up at the sky and pick a familiar bright star. Sight the star in the scope without moving more than 90° in declination. That infers that you should not cross the North or South Celestial Pole in order to sight the first star. Spin the **DIAL** and look for that star's name. There are 35 from which to choose. The [MODE ALIGN STAR](#) reference page lists the alignment stars. If you cannot find the star you have chosen in the list, pick another that is in the list. For example, say you have chosen Sirius. Spin the **DIAL** until you see -

```
ALIGN SIRIUS
```

Centre Sirius in the eyepiece, then press **ENTER**. The display will briefly show something like this -

```
ALIGN SIRIUS  
WARP= -1.75 (1)
```

Your "WARP" number will probably be different, but don't worry. Now pick a second bright alignment star. You can now move the telescope in any direction to sight it. Preferably choose one approximately 30° to 90° away from the first and which will involve having to move the scope in both axes. For example, say you have chosen Capella. Spin the **DIAL** until you see -

```
ALIGN CAPELLA
```

Centre Capella in the eyepiece, then press **ENTER**. The display will briefly show something like this -

```
ALIGN CAPELLA  
WARP= +0.20
```

Your "WARP" number should ideally be as close to 0.00 as possible. A number in the range of -0.5 to +0.5 will probably give you reasonable pointing accuracy depending upon the accuracy of your initial **FIX ALT REF** step and [fabrication errors](#) within your mount.

If your WARP number was much larger you may want to check that you identified the correct stars and repeat the alignment procedure if need be. Otherwise, read the [Troubleshooting Guide](#) and the introductory sections of [SETUP MNT ERRORS](#).

This completes the alignment procedure. Be sure to take the time to read the section on [MODE FIX ALT REF](#). Improving the accuracy by which you perform the **FIX ALT REF** operation will



dramatically improve your pointing accuracy. In particular your attention is drawn to the AUTO ADJUST ON feature of [MODE FIX ALT REF.](#)

Now go on to read [An introductory run.](#)





## An introductory run

This section gives a quick introduction as to some of the ways you might locate objects using your ARGO NAVIS™. It does so by way of examples. It assumes that you have successfully aligned the unit by following the instructions in [Alignment procedures](#). It purposely doesn't give a lot of detail as to how things work (that is covered in detail in the [Operating modes](#) section). However, by following the directions, you should quickly learn by this 'hands-on' experience. Each example builds on the previous example, so it is best to follow them in order. The objects in the examples may not be viewable from your site, or when you perform a search you may not find the same ones, but you should still be able to grasp the basic ideas.

ARGO NAVIS™ provides a great deal of flexibility and power in the many ways it can help you locate or identify objects. For a more detailed discussion of these methods, it is recommended you read the following reference pages –

[MODE CATALOG](#)

[MODE IDENTIFY](#)

[MODE RA DEC](#)

[MODE TOUR](#)

### Examples

**Example 1** – You want to locate the Messier object M53, assuming it is above the horizon.

You have already aligned your scope. Enter MODE CATALOG by spinning the

**DIAL** in the top-level menu and pressing **ENTER** when you see –

**MODE CATALOG**

appear on the display. You will be prompted by a message such as –

**BRIGHT STARS**

where those words will be flashing.

The catalogs are listed in alphabetical order. Spin the **DIAL** clockwise and cycle through the list of available catalogs until you see –

**MESSIER**

then press **ENTER**. Spin the **DIAL** clockwise until the display shows -

**M5**

then press **ENTER**. Spin the **DIAL** clockwise until the display shows –

**M53**

then press **ENTER** again. The display might show something like this –

**M53**  
**GUIDE 45→ 25↓**

Now move the scope in Azimuth (Right Ascension on a polar aligned scope) and try to make the first set of digits as close to 0.0 as possible. For example –



ARGO NAVIS™



M53  
GUIDE 0.0 25↓

Now move the scope in Altitude (Declination on a polar-aligned scope) and try to make the second set of digits as close to 0.0 as possible. For example –

M53  
GUIDE 0.0 0.0

Now look through the eyepiece and hopefully there is your object!

Now press **ENTER** again. You will see a scrolling description of the object –

M53 ALSO KNOWN AS NGC 5024  
GLOBULAR CLUSTER IN COMA  
BERENICES SIZE=12.6' MAG=7.6  
RA=13:12:56 DEC=+18°10'08"  
2000.0 ABOVE HORIZON HB=C29

While the message is being displayed, you can grab the **DIAL** and scroll the text back and forth if you so desire. When you have finished reading it, press **ENTER** or **EXIT** and the display will return to GUIDE mode.

M53  
GUIDE 0.0 0.0

Now press **EXIT** again and return to –

MODE CATALOG

**Example 2** – You want to locate the Sombrero Galaxy, assuming it is above the horizon. You know it has both a Messier and NGC number, but you have forgotten both.

Enter MODE CATALOG and spin the **DIAL** until you see –

POPULAR DEEP SKY

Then press **ENTER**. Spin the **DIAL** to make the first character an 'S', then press **ENTER**. Now spin the **DIAL** and make the second character an '0', then press **ENTER**. Now make the third character an 'M', then press **ENTER**. You should now have a display similar to this –

SOMBRERO GALAXY  
GUIDE 5→0 7↑3

You can then guide to it as you did in the previous example.

You may have noticed while you were spelling out the name of SOMBRERO GALAXY using the **DIAL** and the **ENTER** button, that ARGO NAVIS™ prompted you with the names of other objects that matched your partial input at each point along the way. Once enough characters had been entered to uniquely match the object name you were after, you were guided to it straight away without requiring any more input. This is known as the *Intelligent Editing System*™.

If you press **ENTER**, you will get the scrolling description.

SOMBRERO GALAXY ALSO KNOWN AS  
M104 ALSO KNOWN AS NGC 4594  
GALAXY IN VIRGO SIZE=8.7'x5.3'  
MAG=7.6 SB=12.1 MORPH=SA(s)a sp  
SOMBRERO GALAXY RA=12:40:00  
DEC=-11°37'21" J2000.0 ABOVE  
HORIZON HB=D31,C48

Therefore you could have also retrieved the object as M104 in the **MESSIER** catalog or as NGC 4594 in the **NGC** catalog.



When the display returns to GUIDE mode, press **EXIT**.

**Example 3** – You want to locate the nearest Globular Cluster in Ophiuchus of Magnitude 15 or brighter. Assume the constellation is viewable.

Spin the **DIAL** in the top -level menu until you see -

**MODE IDENTIFY**

then press **ENTER**. Now spin the **DIAL** until you see -

**FIND GLOBULAR CL**

then press **ENTER**. Now spin the **DIAL** anti-clockwise until you see –

**FAINTEST MAG +15**

then press **ENTER**. Now spin the **DIAL** and make the first flashing character an 'O', then press **ENTER**. Now spin the **DIAL** and make the second character a 'P'. The display should now show –

**IN OPHIUCHUS**

Press **ENTER**. The display should now show –

**HORIZON MASK OFF**

Press **ENTER**. ARGO NAVIS™ then will briefly display the message -

**SEARCHING**

before showing you the name of the closest object. The object you find will probably be different, but by way of example, you might see –

**TERZAN 5**  
**FOUND**

Pressing **ENTER** or spinning the **DIAL** one 'click' will put the unit into GUIDE mode.

For example -

**TERZAN 5**  
**GUIDE 76→ 25↓**

After guiding to the object, press **EXIT** or spin the **DIAL** one 'click'. Then press **EXIT** again.

**Example 4** – You want to move the scope around and let ARGO NAVIS™ tell you in 'real-time' what the closest object is.

Enter **MODE IDENTIFY** and spin the **DIAL** until you see -

**FIND ANY OBJECT**

then press **ENTER**. Now spin the **DIAL** until you see –

**FAINTEST MAG ANY**

then press **ENTER**. Now spin the **DIAL** and make the first flashing character an 'A', then press **ENTER**. Make the second character an 'N' then press **ENTER**. Now make the third character a 'Y'. The display should now show –

**IN ANY CONSTEL**



**ARGO NAVIS™**

Press **ENTER**. Now spin the **DIAL** and make the first flashing digit a '3' then press **ENTER**. Make the second digit a '6' then press **ENTER**. Now make the third digit a '0'. The display should now show –

**WITHIN 360°**

Press **ENTER**. The display should now show –

**HORIZON MASK OFF**

Press **ENTER**. ARGO NAVIS™ then will briefly display the message -

**SEARCHING**

before showing you the name of the closest object.

Now move your scope across the sky. Notice how quickly ARGO NAVIS™ provides you with the name of the closest object. It is searching its entire database of tens of thousands of objects several times every second. The speed by which it does this should be testimony to its powerful processing ability.

Whenever the name of an object that looks interesting appears on the display, stop moving the scope. By pressing **ENTER** or spinning the **DIAL** one 'click' you can 'lock-on' to it as ARGO NAVIS™ enters GUIDE mode. Pressing **EXIT** or spinning the **DIAL** one 'click' will return you to the continual search mode.

Remember that while in GUIDE mode you can press **ENTER** to get a scrolling description of the object.

**Example 5** – You would like to tour every Galaxy of 13<sup>th</sup> Magnitude or brighter in Fornax.

Point your scope to the part of the sky from which you would like to begin the tour. The scope does not necessarily have to be pointed at Fornax.

Return to the top-level menu and spin the **DIAL** until you see -

**MODE TOUR**

then press **ENTER**. Now spin the **DIAL** until you see –

**FIND GALAXY**

then press **ENTER**. Now spin the dial until you see –

**FAINTEST MAG 13**

then press **ENTER**. Now spin the **DIAL** and make the first flashing character an 'F'. The display should now show –

**IN FORNAX**

Press **ENTER**. The display should now show –

**HORIZON MASK OFF**

Press **ENTER**. ARGO NAVIS™ then will briefly display the message -

**SEARCHING**

before showing you the name of the closest Galaxy in Fornax of 13<sup>th</sup> Magnitude or brighter. Notice that you



have automatically been put into GUIDE mode. For example –

NGC 1049  
GUIDE 14→ 35↓

You can then move the scope and guide to the object. While in GUIDE mode, if you spin the **DIAL** one 'click' clockwise, ARGO NAVIS™ will find you the next closest object, and so forth. When you reach the end of the tour, you will see the message –

**NO MORE OBJECTS**

You can even spin the **DIAL** anti-clockwise at any time and go backwards through the tour. While it is searching backwards, you will briefly see the message –

**BACKTRACKING**

At any time while in GUIDE mode you can press **ENTER** to get a scrolling description. Remember by grabbing the **DIAL** you can stop the automatic scrolling and instead scroll manually.

That concludes this brief introductory run. Hopefully by now you might have got some feel for how the unit operates. ARGO NAVIS™ has many more features than are mentioned here. As suggested earlier, you are encouraged to read the various reference pages in the [Operating modes](#) section of this manual to help give you further insight into its various capabilities.



ARGO NAVIS™

## Operating modes

The ARGO NAVIS™ interface is designed as a set of menus. This section describes the purpose of each menu and how to use it. Examples are provided. Each menu is listed in alphabetical order, which provides for a handy reference.

Essentially there are two main sets of menus. There are the top-level MODE menus and there are the SETUP menus. The SETUP menus are accessed via entering MODE SETUP in the top-level menu.

Use the **DIAL** to select a menu. Use the **ENTER** button to enter the menu and the **EXIT** button to exit it.

The MODE menus are –

- MODE ALIGN
- MODE ALIGN STAR
- MODE AZ/ALT
- MODE CATALOG
- MODE ENCODER
- MODE EQ TABLE
- MODE FIX ALT REF
- MODE IDENTIFY
- MODE RA DEC
- MODE SETUP
- MODE SIDEREAL
- MODE STATUS
- MODE TIME
- MODE TIMER
- MODE TOUR

The SETUP menus are –

- SETUP ALIGN PICK
- SETUP ALT REF
- SETUP ALT STEPS
- SETUP ARCHIVE
- SETUP ATLAS
- SETUP AZ STEPS
- SETUP BRIGHTNESS
- SETUP CONTRAST
- SETUP DATE/TIME
- SETUP DEBUG
- SETUP DEFAULTS
- SETUP ENC TIMING
- SETUP EQ TABLE
- SETUP GOTO
- SETUP GUIDE MODE
- SETUP LCD HEATER
- SETUP LOAD CAT
- SETUP LOCATION
- SETUP MOUNT
- SETUP MNT ERRORS
- SETUP REFRACTION
- SETUP SCRATCH
- SETUP SCROLL
- SETUP SERIAL



ARGO NAVIS™

## MODE ALIGN

### Function

MODE ALIGN allows you to align ARGO NAVIS™ on the 'Current Object'. The 'Current Object' is the last object referenced in any of the following modes –

- **MODE ALIGN STAR**
- **MODE CATALOG**
- **MODE IDENTIFY**
- **MODE TOUR**

Therefore, you can align ARGO NAVIS™ on any object at any time, including during your initial alignment.

See [MODE ALIGN STAR](#) for an alternative and convenient way of aligning from a list of 35 bright alignment stars.

### Using MODE ALIGN

Enter MODE ALIGN by spinning the **DIAL** in the top-level menu and pressing **ENTER** when you see –

**MODE ALIGN**

appear on the display. You will then be prompted with the message **ALIGN** followed by the name of the Current Object. When ARGO NAVIS™ is first powered-on, the default Current Object is the first object from the first catalog.

Centre the Current Object in your eyepiece (not just the finder scope), then press **ENTER**. A status message will briefly appear on the bottom line of the

display reporting the "WARP" factor for the alignment. See [MODE ALIGN STAR](#) for a complete discussion of the WARP factor and alignment process.

### Examples

You would like to align on Jupiter.

In the top level menu, spin the **DIAL** until you see –

**MODE CATALOG**

then press **ENTER**. Spin the DIAL until you see –

**PLANETS/SUN**

then press **ENTER**. Spin the DIAL until you see –

**JUPITER**

then press **EXIT**. Spin the DIAL anti-clockwise until you see –

**MODE ALIGN**

then press **ENTER**. The display should then show –

**ALIGN JUPITER**

Centre Jupiter in your eyepiece (not just the finder scope), then press **ENTER**.

A status message will briefly appear on the bottom line of the display reporting the "WARP" factor for the alignment.



The WARP factor is the difference between the angular distance the telescope moved and the angular distance between two alignment stars or objects as a function of time.

The details of the WARP factor message will differ depending upon the mount type you have set in [SETUP MOUNT](#), whether you have set AUTO ADJUST ON or OFF in [MODE FIX ALT REF](#) and whether this is the first or subsequent alignment. See [MODE ALIGN STAR](#) for a full explanation.

For example, you might see –

```
ALIGN JUPITER  
WARP= -0.08
```

This indicates that you have aligned on Jupiter. In this case, the alignment was a second or subsequent alignment (see [MODE ALIGN STAR](#) for explanation). The WARP factor was  $-0.08$  degrees, which is the difference between the computed angular positions of the alignment objects and the angular distance the telescope moved. In this case the alignment should probably give reasonable results since the WARP factor was close to 0.00.

Note that if you have non-zero terms in the [SETUP MNT ERRORS/SET ERROR VALUES/IN USE NOW](#) submenu, rather than the word

```
WARP
```

appear, the display will show the word –

```
@WARP
```

This acts a reminder that you have non-zero mount terms and an associated pointing model in place.

#### See also

[MODE ALIGN STAR](#)

[MODE CATALOG](#)

[MODE FIX ALT REF](#)

[SETUP MOUNT](#)

[SETUP MNT ERRORS](#)



ARGO NAVIS™

## MODE ALIGN STAR

### Function

MODE ALIGN STAR allows you to align ARGO NAVIS™ quickly and conveniently on any of 35 bright naked-eye stars. ARGO NAVIS™ can actually be aligned on any object (see [MODE ALIGN](#)). However, the convenience of MODE ALIGN STAR makes it compelling to use, particularly for your initial alignments.

### Using MODE ALIGN STAR

Enter MODE ALIGN STAR by spinning the **DIAL** in the top-level menu and pressing **ENTER** when you see –

**MODE ALIGN STAR**

appear on the display. Then spin the **DIAL** until the name of the star you wish to align on appears.

The alignment stars are listed in the following table -

Name	Constellation	Greek	RA J2000.0	Dec J2000.0	Mag
ACHERNAR	ERI	ALPHA	01:37:43	-57:14	0.5
ACRUX	CRU	ALPHA	12:26:36	-63:06	1.3
AL NAIR	GRU	ALPHA	22:08:15	-46:57	1.7
ALBIREO	CYG	BETA	19:30:43	+27:51	3.1
ALDEBARAN	TAU	ALPHA	04:35:55	+16:30	0.9
ALPHARD	HYA	ALPHA	09:27:35	-08:27	2.0
ALPHERATZ	AND	ALPHA	00:00:58	+29:05	2.1
ALTAIR	AQL	ALPHA	19:50:47	+08:44	0.8
ANTARES	SCO	ALPHA	16:29:24	-26:25	1.0
ARCTURUS	BOO	ALPHA	14:15:40	+19:14	0.0
BETELGEUSE	ORI	ALPHA	05:55:10	+07:24	0.4
CANOPUS	CAR	ALPHA	06:23:57	-52:42	-0.7
CAPELLA	AUR	ALPHA	05:16:41	+46:00	0.1
CASTOR	GEM	ALPHA	07:34:36	+31:53	1.6
DENEK	CYG	ALPHA	20:41:26	+45:17	1.3
DENEKOLA	LEO	BETA	11:49:03	+14:51	2.1
DUBHE	UMA	ALPHA	11:03:43	+61:45	1.8
FOMALHAUT	PSA	ALPHA	22:57:39	-29:37	1.2



ARGO NAVIS™



HADAR	CEN	BETA	14:03:48	-60:22	0.6
KAUS AUSTRALIS	SGR	EPSILON	18:24:11	-34:22	1.9
MIMOSA	CRU	BETA	12:47:43	-59:41	1.3
MIRFAK	PER	ALPHA	03:34:19	+49:52	1.8
MIZAR	UMA	ZETA	13:23:55	+54:56	2.3
NAVI	CAS	GAMMA	00:56:42	+60:43	2.5
POLARIS	UMI	ALPHA	02:31:50	+89:16	2.0
POLLUX	GEM	BETA	07:45:20	+28:01	1.1
PROCYON	CMI	ALPHA	07:39:18	+05:21	0.4
RASALHAGUE	OPH	ALPHA	17:34:56	+12:34	2.1
REGULUS	LEO	ALPHA	10:08:22	+12:13	1.4
RIGEL	ORI	BETA	05:14:32	-08:12	0.1
RIGEL KENT	CEN	ALPHA	14:39:37	-60:38	0.0
SIRIUS	CMA	ALPHA	06:45:09	-16:43	-1.5
SPICA	VIR	ALPHA	13:25:11	-11:10	1.0
SUHAIL	VEL	LAMBDA	09:08:00	-43:26	2.2
VEGA	LYR	ALPHA	18:36:56	+38:47	0.0

Never use Polaris as an alignment star on an Equatorial mount and never use a star near the Zenith for alignment of an Az/Alt mount such as a Dobsonian.

For German Equatorial Mount users only - if you are in the Northern Hemisphere, place the tube on the West side of the mount. If you are in the Southern Hemisphere, place the tube on the East side of the mount. If you are going to do the first star alignment with the tube on the opposite side of the mount, go to [SETUP ALT STEPS](#) and change the direction sense sign. Be sure to change it back when you want to do a first-star alignment on the original side of the mount.

Centre the chosen alignment star in your eyepiece (not just the finder scope),

then press **ENTER**. A status message will briefly appear on the bottom line of the display reporting the “WARP” factor for the alignment.

The WARP factor is the difference between the angular distance the telescope moved and the angular distance between two alignment stars or objects as a function of time.

When the **ENTER** button is pressed, ARGO NAVIS™ refers to its internal catalogs and calculates the position of the alignment object in terms of its Azimuth and Altitude at that moment in time. Since it also keeps track of the movement of the encoders, it has all the information necessary to calculate the WARP factor.

If you had selected FORK EXACT ALIGN or GEM EXACT ALIGN in the [SETUP MOUNT](#)



menu, then the WARP factor will always be 0.00. For example, if you had selected to align such a mount using Rigel, a Magnitude 0.1 star in Orion, you would receive this message -

```
ALIGN RIGEL
WARP= +0.00
```

For FORK EXACT ALIGN or GEM EXACT ALIGN mount settings where the mount is accurately polar-aligned, only one alignment star is necessary to align ARGO NAVIS™.

For ALTAZ/DOBSONIAN, FORK ROUGH ALIGN and GEM ROUGH ALIGN mount settings, two alignment stars and a FIX ALT REF (see [MODE FIX ALT REF](#)) step are necessary.

If you are performing the first ALIGN STAR or ALIGN operation for a mount that requires two alignment stars, then the designation '(1)' will appear after the WARP factor to remind you that this was only the first alignment. For example -

```
ALIGN SIRIUS
WARP= +2.32 (1)
```

If you are performing the second or subsequent ALIGN STAR or [ALIGN](#) operation for a mount that requires two alignment stars, then you should take special note of the WARP factor when it appears. In general, you will want to achieve a WARP factor as close to 0.0 as possible.

If you had set AUTO ADJUST OFF in [MODE FIX ALT REF](#) then a perfect alignment would give you a WARP factor of 0.00, though values in the range of +0.50 to -0.50 should normally achieve an acceptable alignment. For example -

```
ALIGN VEGA
WARP= -0.10
```

indicates that you have performed a second or subsequent alignment. The alignment star was Vega. The WARP factor was 0.1 degrees, which is the difference between the computed angular positions of the alignment objects and the angular distance the telescope moved. In this case, the alignment should probably give reasonable results.

If you had set AUTO ADJUST ON in MODE FIX ALT REF then you should always see a WARP factor of 0.00 unless an ALT REF adjustment could not be computed (see [MODE FIX ALT REF](#)). If an ALT REF adjustment could be automatically computed, the designation '(A)', for 'Automatic', will appear after the WARP factor to remind you that AUTO ADJUST is ON. For example -

```
ALIGN BETELGEUSE
WARP= +0.00 (A)
```

indicates that you have performed a second or subsequent alignment. The alignment star was Betelgeuse and ARGO NAVIS™ automatically computed the ALT REF adjustment.

When the automatic ALT REF adjustment cannot be computed, the designation '(X)' will appear after the WARP factor as a warning. For example -

```
ALIGN BETELGEUSE
WARP= -94.66 (X)
```

indicates an alignment on Betelgeuse has failed because the ALT REF adjustment could not be computed. See [MODE FIX ALT](#)



[REF](#) for an explanation of the reasons the alignment may have failed.

Note that if you have non-zero terms in the [SETUP MNT ERRORS](#)/SET ERROR VALUES/IN USE NOW submenu, rather than the word

WARP

appear, the display will show the word –

∂WARP

This acts a reminder that you have non-zero mount terms and an associated pointing model in place.

If you perform a second or subsequent alignment and ARGO NAVIS™ has failed to detect that the telescope has moved, the alignment will not be performed and a warning message will appear. For example –

ALIGN ALPHERATZ  
SAME TELE POS ?

Indicates an alignment on the star Alpheratz has failed because the telescope did not appear to move. In this situation, you might want to check your encoder cable and connections.

Additional information, both introductory and advanced, that discusses many of the causes of pointing errors and how to diagnose them, can be found in the [SETUP MNT ERRORS](#) section of this Manual.

Note: For German Equatorial Mount users only – your second alignment star

can be sighted with the optical tube on either side of the mount.

**See also**

[MODE ALIGN STAR](#)

[MODE ALIGN](#)

[MODE FIX ALT REF](#)

[SETUP MOUNT](#)

[SETUP MNT ERRORS](#)



## MODE AZ ALT

### Function

MODE AZ ALT allows you to determine the position of the telescope in an azimuth-altitude co-ordinate system. This mode assumes that you have performed a valid alignment, that the current date and time have been set in SETUP DATE/TIME and that your location, in particular your current latitude and longitude, have been set in SETUP LOCATION.

### Using MODE AZ ALT

The azimuth values range from 0° to 360°, where north is 0° and east is 90°.

The altitude values range from -90° to +90°, with 90° at the zenith, -90° at the nadir and 0° at the horizon.

The angles displayed are shown in degrees and arc minutes.

Enter MODE AZ ALT by spinning the **DIAL** in the top-level menu and pressing **ENTER** when you see -

**MODE AZ ALT**

The display will show the telescope's azimuth on the left and the telescope's altitude on the right. If a valid alignment has not been performed, a scrolling warning message will be displayed, possibly similar to this one -

**TWO SIGHTINGS ARE REQUIRED. FIX  
ALT REF MAY BE REQUIRED.**

**WARNING - DISPLAYED VALUES MAY  
NOT BE VALID.**

Otherwise the bottom line of the display shows the name of the constellation that the telescope is currently pointing towards. For example -

**195°48' +37°26'  
CETUS**

suggests the telescope is pointing southwest to 195°48' and is elevated to point 37°26' above the horizon.

Pressing **ENTER** again will briefly display the page number of the default atlas (see [SETUP ATLAS](#)) that covers the area of the sky the telescoping is pointing to -

**195°48' +37°26'  
MSA=VOL I 262**

In this example, Volume I page 262 of the Millennium Star Atlas™.

To leave MODE AZ ALT, press **EXIT**.

### See also

[MODE ALIGN](#)

[MODE ALIGN STAR](#)

[MODE RA DEC](#)

[SETUP DATE/TIME](#)

[SETUP LOCATION](#)



ARGO NAVIS™

## MODE CATALOG

### Function

MODE CATALOG allows you to look-up an object by name then to optionally GUIDE to it and to also optionally retrieve more information about it. When an object is accessed in MODE CATALOG it automatically becomes the Current Object. That means that it will appear as the alignment object when entering MODE ALIGN.

Objects in the ARGO NAVIS™ are grouped in a number of catalogs. MODE CATALOG allows you to browse the available catalogs and to either access a particular object in a particular catalog or to browse objects within the catalog.

### Using MODE CATALOG

Enter MODE CATALOG by spinning the DIAL in the top-level menu and pressing ENTER when you see –

MODE CATALOG

appear on the display. You will be prompted by a message such as –

BRIGHT STARS

where the words BRIGHT STARS will be flashing.

By spinning the DIAL, you can cycle through the list of available catalogs. The catalogs are listed in alphabetical order.

The current catalogs are –

- **ASTEROIDS** (assuming your ARGO NAVIS™ has an [asteroid catalog](#) currently loaded)
- **BRIGHT STARS** (a selection of stars to magnitude 6.5, particularly those with well-known historical names, such as BETELGEUSE and those with Bayer Greek alphabet or Flamsteed numbers. Names have constellation abbreviation first, then Bayer or Flamsteed identifier. For example, FOR ZETA for Zeta Fornax. They are ordered this way to make the catalog easier to browse)
- **COMETS** (assuming your ARGO NAVIS™ has a [comet catalog](#) currently loaded)
- **FROM PLANETARIUM** (consists of the single “FROM PLANETARIUM” object. When ARGO NAVIS™ is interfaced via a serial port to an appropriate planetarium program and a GOTO command is issued from that program, the RA/Dec coordinates corresponding to that GOTO position and optionally the name of some associated object are transmitted to the “FROM PLANETARIUM” object. This then allows you to GUIDE to the position that was sent from the planetarium program)
- **IC** (non-stellar selections from the Index Catalogue)
- **MESSIER** (the complete Messier Catalogue)



ARGO NAVIS™

- **MISC BRIGHT NEB**  
(miscellaneous bright nebulae, such as emission and reflection nebulae, that do not appear in the MESSIER, NGC or IC catalogs)
  - **MISC DARK NEBULA**  
(miscellaneous dark nebulae)
  - **MISC DOUBLE STAR**  
(miscellaneous double stars that do not appear in the BRIGHT STAR catalog)
  - **MISC GALAXIES** (miscellaneous galaxies that do not appear in the MESSIER, NGC or IC catalog, such as ESO, MCG, UGC and Local Group galaxies)
  - **MISC GALAXY CLUS**  
(miscellaneous galaxy clusters such as the Abell and Hickson clusters)
  - **MISC GLOBULARS** (miscellaneous globular clusters that do not appear in the MESSIER, NGC or IC catalogs)
  - **MISC OPEN CLUST**  
(miscellaneous open clusters that do not appear in the MESSIER, NGC or IC catalogs)
  - **MISC PLANETARIES**  
(miscellaneous planetary nebulae that do not appear in the MESSIER, NGC or IC catalogs)
  - **MISC VARIABLE ST**  
(miscellaneous variable stars that do not appear in the BRIGHT STAR catalog)
  - **NGC** (the complete New General Catalogue, including all non-stellar, stellar and non-existent objects. Also includes 'letter suffixed' objects such as NGC 554A and NGC 554B and all objects that are also Messier objects)
  - **PLANETS/MOON/SUN** (in our solar system)
  - **POPULAR DEEP SKY** (a convenient cross reference to objects in the MESSIER, NGC or IC catalogs that have popular names, such as ANDROMEDA GALAXY, GHOST OF JUPITER and TARANTULA NEBULA)
  - **SATELLITES** (artificial earth orbiting satellites - assuming your ARGO NAVIS™ has a [satellite catalog](#) currently loaded)
  - **SCRATCH** (see [SETUP SCRATCH](#))
  - **USER OBJECTS** (assuming your ARGO NAVIS™ has [user defined objects](#) currently loaded)
- By way of example, say you are interested in the planetary nebula popularly known as the 'Ghost of Jupiter'. Spin the **DIAL** and press **ENTER** when you see -
- POPULAR DEEP SKY**
- You might be then presented with the message in the top line that reads -
- 47 TUCANAE**
- where the '4' will be flashing. By spinning the **DIAL** and pressing the **ENTER** button, you can use the *Intelligent Editing System*™ to enter the name of the object in which you are interested, in this example, Ghost of Jupiter. By spinning the **DIAL** clockwise (+), the symbol at the flashing cursor position will alphabetically





increase. By spinning the **DIAL** anti-clockwise (-), the symbol will decrease. 'Wrapping' occurs when the 'maximum' symbol is displayed and the **DIAL** is turned clockwise or when the 'minimum' symbol is displayed and the **DIAL** is turned anti-clockwise.

**Note:** A symbol might be a number or letter or even a special character such as a '/', a '-' or even a space ' '. In general, ARGO NAVIS™ treats special characters as alphabetically before numbers and numbers as alphabetically before letters. See the section on [How Argo Navis orders its symbols](#) for a reference table.

Spell out the name of the object by spinning the **DIAL** and pressing **ENTER** to select a character and advance the cursor to the next editable field. The *Intelligent Editing System*™ will only prompt you with valid names. A tip is to concentrate just on one letter at a time. In this example, spin the **DIAL** clockwise until the letter 'G' appears at the flashing cursor position.

The display might show something like

GEM CLUSTER

Now press **ENTER** to advance the cursor to the next editable field. In this case the display might continue to show

GEM CLUSTER

but now the 'E' in GEM will be flashing. Spin the **DIAL** clockwise until an 'H' appears at that place. The display might then show -

GHOST OF JUPITER

with the 'H' still flashing. Now press **ENTER** again. If a valid alignment has not been performed, you will see the following warning message -

GHOST OF JUPITER  
NOT ALIGNED

In this case pressing **ENTER** again will give a further alignment warning message. If a valid alignment has been previously performed, ARGO NAVIS™ will enter GUIDE mode.

**Note :** As a special feature, if you select the PLANETS catalog, the planet of interest can be found by rotating the **DIAL**. The planets are listed in Solar System order and are spelt out in full. When the name of the planet of interest appears on the display, simply press **ENTER** to go to GUIDE mode.

Continuing with our example, the display might read -

GHOST OF JUPITER  
GUIDE 101→25↓

This means the telescope should be moved 101° in azimuth and 25° in altitude to locate The Ghost of Jupiter. The arrows represent a relative movement. For example, if the → arrow is displayed, even though the arrow points to the right, whether one moves the telescope to the right or to the left is dependent on several factors according to your setup. If you wish to change the default direction sense of one or both arrows, you can do so by





changing the settings in [SETUP GUIDE MODE](#).

In any case, you should move the telescope in the direction that causes the angle to become smaller. As the telescope is moved, the display continually updates the angles and changes the direction arrows if the object is passed. When an angle less than 10° is displayed, the arrow will move to double as a decimal point. For example, 5↓3 means 5.3°.

Generally you might find it is easier to move the telescope in one axis at a time. When the telescope is at the correct position, you will see -

GHOST OF JUPITER  
GUIDE 0.0 0.0

If a proper alignment has been performed, the object should appear within the field of view of a moderate power eyepiece (for example, one that gives a field of view of about 30 arc minutes). If objects do not appear consistently within the field of view, you might want to perform a re-alignment or review the section [Factors that affect pointing accuracy](#).

### Detailed object description

At any time during GUIDE MODE, if you press **ENTER**, a scrolling description of the object is given. Typical descriptions include the full name of the object, other popular names the object might be known by, what constellation the object is in, the size of the object, the visual magnitude of the object, its surface brightness, in the case of stars its spectral luminosity class, in the case of galaxies its abbreviated

Hubble morphology, the object's Right Ascension and Declination, whether it is currently above or below the horizon and what volume and page of the default atlas the object would appear on (See [SETUP ATLAS](#)). For the Moon, you can determine its current phase and the local date and time of the next phases.

While the description is scrolling (to change the default scroll rate, see [SETUP SCROLL](#)), you can press **EXIT** or **ENTER** to have ARGO NAVIS™ go back to GUIDE MODE or wait until the description has completed scrolling and ARGO NAVIS™ will automatically return to GUIDE MODE. If you move the **DIAL** while the description is scrolling, manual scroll mode is entered.

Turning the **DIAL** clockwise scrolls the message forward for convenient reading at your leisure while turning the **DIAL** anti-clockwise scrolls the message in reverse. By pressing **EXIT** or **ENTER** while in manual scroll mode, ARGO NAVIS™ will return to GUIDE MODE

### Sequentially stepping through a catalog

While in GUIDE MODE, if you spin the **DIAL** clockwise (+), you can browse the next object in the currently selected catalog. Similarly if you rotate the **DIAL** anti-clockwise, you can browse the previous object.

### Below horizon indication

Whenever you are about to locate an object you may want to automatically determine if it is below your local horizon or not.



To do so, ensure that your time zone, date and local time is correctly set in [SETUP DATE/TIME](#), that your latitude and longitude are correctly set in [SETUP LOCATION](#) and that in [SETUP GUIDE MODE](#) you have set GUIDE BELOW HORZ to H INDICATOR=ON.

For example, if the display showed -

GRUS QUARTET  
GUIDE 19→132↓H

the H symbol at the end of the second line indicates that the GRUS QUARTET is currently beneath your local horizon.

### Examples

*Example 1 - You want to observe the Ghost of Jupiter.*

Spin the **DIAL** until you see -

MODE CATALOG

then press **ENTER**. Spin the **DIAL** until you see -

POPULAR DEEP SKY

then press **ENTER**.

Use the *Intelligent Editing System*<sup>™</sup> to enter the name of GHOST OF JUPITER and then press **ENTER**.

The display might then show -

GHOST OF JUPITER  
GUIDE 5→0 7↓3

Move the telescope in both axes until the display reads -

GHOST OF JUPITER  
GUIDE 0.0 0.0

Pressing **ENTER** again will display the following scrolling information about the object.

GHOST OF JUPITER ALSO KNOWN AS NGC 3242 PLANETARY NEBULA IN HYDRA SIZE=25" MAG=7.8 GHOST OF JUPITER. BLUE GREEN. BRIGHT INNER DISK & FAINT HALO RA=10:24:46 DEC=-18°38'34" J2000.0 ABOVE HORIZON MSA=VOL II 851

While the text is scrolling, you can enter manual scroll mode by moving the **DIAL**.

**Note:** Had you known that the Ghost of Jupiter is also known as NGC 3242, you might well have accessed it via the NGC catalog.

Note that when SAMPLE MODE is ON, in the [SETUP MNT ERR/ACQUIRE DATA](#) submenu, rather than a scrolling description immediately appearing, a new submenu appears.

In this case, by spinning the **DIAL** a detent 'click' at a time, the bottom line of the display can be alternated as follows –

- DESCRIPTION
- SAMPLE MNT ERROR

If you want to view the description of the object, spin the **DIAL** until the word DESCRIPTION appears and then press **ENTER**. If you want to sample the position of an object as part of a pointing test, spin the **DIAL** until the words

SAMPLE MNT ERROR appears and then press **ENTER** (See [SETUP MNT ERRORS](#) for details).

Pressing **EXIT** will return you to GUIDE mode -

GHOST OF JUPITER  
GUIDE 0.0 0.0

Pressing **EXIT** again will return you to the top-level menu -

MODE CATALOG

*Example 2 - You want to align on MARS.*

Spin the **DIAL** until you see –

MODE CATALOG

then press **ENTER**. Spin the **DIAL** until you see -

PLANETS/SUN

then press **ENTER**.

Spin the **DIAL** until you see -

MARS

Press **EXIT**. Mars is now the Current Object.

Spin the **DIAL** counter-clockwise until the display reads –

MODE ALIGN

then press **ENTER**.

The display should show -

## ALIGN MARS

Centre Mars in the eyepiece and press **ENTER** to perform the alignment.

*Example 3 - You want to determine the current Moon phase and when the next New Moon will be.*

Spin the **DIAL** until you see -

MODE CATALOG

then press **ENTER**. Spin the **DIAL** until you see -

PLANETS/MOON/SUN

then press **ENTER**.

Spin the **DIAL** until you see –

MOON

Press **ENTER** and then press **ENTER** again. A scrolling description will appear. Whilst the text is scrolling, you can enter manual scroll mode by moving the **DIAL**.

MOON CURRENTLY IN VIRGO MAG=-11.7 DIA=30.4' ILLUM=38.6%  
PHASE=LAST QUARTER NEXT LAST QTR=10-DEC-2017 18:51 LOCAL  
NEXT NEW MOON=18-DEC-2017 17:31 LOCAL NEXT FIRST QUARTER=26-DEC-2017 20:20 LOCAL NEXT FULL MOON=2-JAN-2018 13:24 LOCAL  
DIST=392462KM RA=12:16:55 DEC=+02°48'00" J2000.0 BELOW HORIZON HB=E12,C48

From the description the Moon phase is currently close to Last Quarter and the

next New Moon will be on 18 DEC 2017  
at 17:31 local time.

*Example 4 – Whenever you are about to locate an object, you want to automatically determine if it is below your local horizon or not.*

Ensure your time zone, date and local time is correctly set in [SETUP DATE/TIME](#), that your latitude and longitude are correctly set in [SETUP LOCATION](#) and that in [SETUP GUIDE MODE](#) you have set GUIDE BELOW HORZ to H INDICATOR=ON.

For example, if the display showed -

```
TARANTULA NEBULA  
GUIDE 169→108↓H
```

the H symbol at the end of the second line indicates that the TARANTULA NEBULA is currently beneath your local horizon.

#### **See also**

[MODE ALIGN](#)

[MODE ALIGN STAR](#)

[SETUP DATE/TIME](#)

[SETUP LOCATION](#)

[SETUP GUIDE MODE](#)

[Catalogs](#)

[How Argo Navis orders its symbols](#)



# ARGO NAVIS™

## MODE ENCODER

### Function

MODE ENCODER allows you to check the functioning of your encoders. You can display the encoder values either as angles or encoder steps.

### Using MODE ENCODER

Enter MODE ENCODER by spinning the **DIAL** in the top-level menu and pressing **ENTER** when you see –

**MODE ENCODER**

appear on the display. The display will then show the current encoder values either as angles or as steps, depending upon what state MODE ENCODER was in when last exited since power-on.

By way of example, in the case of the angle display mode, the display might show something like this –

**AZ/ALT ENC ANGLE**  
**313.77° +014.37°**

This suggests that the current azimuth encoder is at an angle of 313.77° and the altitude encoder value is at 14.37°.

As the scope is rotated in each axis, the appropriate value should change. This is a good way of checking that the encoders are functioning correctly and that the cabling to each encoder has not been inadvertently swapped. Azimuth encoder values range from 0° to 360°. Altitude encoder values range from –180° to +180°.

The direction sense of the encoders is set in [SETUP ALT STEPS](#) and [SETUP AZ STEPS](#). Assume that each encoder has its shaft pointing upwards and is being viewed from above. When the Azimuth encoder shaft is rotated clockwise, the Azimuth angle will decrease. When the Altitude encoder shaft is rotated clockwise, the Altitude angle will increase.

The 0° point of the Azimuth encoder is simply the position the encoder was in when ARGO NAVIS™ was powered on.

The 0° point of the Altitude encoder is initially the position the encoder was in when ARGO NAVIS™ was powered on. If a polar aligned mount was set in [SETUP MOUNT](#), the 0° point will become equivalent to Declination 0° after a valid [MODE ALIGN](#) or [MODE ALIGN STAR](#) operation has been performed. If a non-polar aligned mount was set, the 0° point is determined when a [FIX ALT REF](#) operation is performed and subsequently might be automatically adjusted during an alignment operation if [AUTO ADJUST ON](#) was set (see [MODE FIX ALT REF](#)).

In all cases, once ARGO NAVIS™ has been aligned, the 0° point should therefore correspond to the tube being at right-angles to the Azimuth axis. In the case of a polar-aligned mount, the +90° point would then correspond to the North Celestial Pole and the -90° point to the South Celestial Pole. For non-polar aligned mounts, the +90° point would correspond to the tube pointing upwards



and being at right angles to the base (i.e. the Azimuthal plane).

If the **DIAL** is rotated one detent ‘click’ at a time, the display can be alternated between AZ/ALT ENC ANGLE and AZ/ALT ENC STEPS modes. For example –

```
AZ/ALT ENC STEPS
+1235          +5790
```

suggests that the Azimuth encoder is at the 1235<sup>th</sup> step point and the Altitude encoder is at the 5790<sup>th</sup> step point. Azimuth steps range from 0 to the number of steps set in SETUP AZ STEPS minus 1. Altitude steps range from 0 to the number of steps set in SETUP ALT STEPS minus 1. The ‘+’ or ‘-’ signs in this mode are the same as what they were set to in SETUP ALT STEPS and SETUP AZ STEPS. Assume that each encoder has its shaft pointing upwards and is being viewed from above. When either encoder shaft is rotated clockwise, their absolute steps value (i.e. ignoring the encoder sign) will increase. The 0-step point of both encoders is simply the position the encoder was in when ARGO NAVIS™ was powered on. Unlike the angle view mode, the Altitude encoder 0-step point is not influenced by performing an FIX ALT REF, ALIGN, or ALIGN STAR operation.

When ARGO NAVIS™ has DEBUG set to ON, in MODE SETUP, [SETUP DEBUG](#), a third mode will appear when the **DIAL** is spun in MODE ENCODER. An example of the display is shown here –

```
AZ/ALT ENC RAW
+1235          +5790
```

This mode is similar to the AZ/ALT ENC ANGLE mode except that the altitude reading is not affected by a FIX ALT REF, ALIGN, or ALIGN STAR operation. Normally you should have the DEBUG set to OFF and so this mode would normally be hidden. Having DEBUG set to ON will send additional information to your **SERIAL1** port which can be used by Wildcard Innovations during customer support sessions. This debug data may interfere with other communications that you may have occurring on **SERIAL1** so therefore it is best to keep DEBUG set to OFF unless instructed otherwise.

### Encoder sampling and errors

While it is powered-on, ARGO NAVIS™ samples the position of each encoder up to a possible 16,000 times every second. This is known as the encoder sampling rate. The encoder sampling rate is determined by the values set in [SETUP ENC TIMING](#). If an encoder is turned too quickly, the sampling rate may be exceeded and steps might be “missed”. In theory, each encoder can be turned at a maximum instantaneous rate such that it does not produce more steps per second than approximately half the sampling rate. If the sampling rate is exceeded, one of the following messages might appear on the display –

**AZ ENCODER ERROR**

means the Azimuth encoder has missed one or more steps.

**ALT ENCODER ERR**





means the Altitude encoder has missed one or more steps.

### **BOTH ENCODER ERR**

means both encoders have missed one or more steps.

For most practical purposes the encoder sampling rate will never be exceeded while moving a telescope if the correct values have been set in [SETUP ENC TIMING](#). For example, if the encoder sampling rate had been set to 11kHz (11,000 samples per second) in [SETUP ENC TIMING](#) and if the telescope were fitted with ungeared 8192-step encoders, the scope would have to be rotated in either axis a full 360° in less than 1-and-one-half seconds. However, it is possible to exceed the sampling rate if, for example, the encoders are held freely in the hand and their shafts rotated quickly with the fingers. Alternatively, if the encoders are mounted on a scope but have been geared to produce a much higher resolution, the user should be careful not to exceed the sampling rate.

To calculate the maximum allowed instantaneous rotational rate in degrees per second, refer to the table in the [SETUP ENC TIMING](#) section and determine the sampling rate according to your [SETUP ENC TIMING](#) TON and TOFF settings. Multiply the sampling rate by 180 and divide by the number of encoder steps that occur when you rotate the scope axis 360°.

For example, say you have geared an 8192-step encoder 2.5 times to give an effective resolution of 20,480 steps. Say you also have TON=2 and TOFF=10 set in [SETUP ENC TIMING](#), which you determine in

the table in the [SETUP ENC TIMING](#) section to correspond to an effective sample rate of 11,500Hz.

Therefore  $11,500 * 180 / 20,480 = 101^\circ$  per second.

The encoder error messages can also appear if the batteries are running flat or if there is a fault with the encoder cabling or possibly the encoder itself.

### **Examples**

*Example 1 - You suspect that one of your encoder shafts is slipping.*

During the daytime, using a high power eyepiece, sight a distant stationary object. Enter MODE ENCODER and take note of the step reading in the axis you suspect has a slippage problem. Move the telescope through a large angle in the suspect axis then return and centre the distant object again. Take note of the step reading. If it is not the same as the original reading within a step or two, chances are you have a slippage problem.

*Example 2 - You have an encoder mounted on your Azimuth axis. Unfortunately, you have forgotten what its resolution is and the encoder has no marking.*

During the daytime, using a high power eyepiece, sight a distant stationary object. Power off ARGO NAVIS™ then power it back on. Enter MODE ENCODER and take note that the Azimuth step reading is 0. Move the scope in Azimuth a full 360° and re-centre the object in the eyepiece. Take note of the Azimuth step reading again. This number, plus 1, is your Azimuth encoder resolution. Enter that value into the SETUP AZ STEPS menu. If the encoder





was not geared, chances are the value will be a multiple of 1000, such as 10,000 or 4,000 or a power of two, such as 2048, 4096 or 8192.

*Example 3 – You have a Dobsonian scope and have aligned ARGO NAVIS™ but suspect a problem with the FIX ALT REF step you performed.*

Enter MODE ENCODER and put it in angle display mode. Move the scope tube so that it is pointing vertically and at right angles to the base (i.e. the Azimuthal plane.) The encoder altitude reading should indicate +90°.

*Example 4 – You have a roughly aligned equatorial mount but suspect a problem with the FIX ALT REF step you performed.*

Move the tube so that it is at right angles to the Azimuth axis and oriented the normal way up you would observe through it. The encoder altitude reading should read 0°. As you move the tube in altitude toward the north, the Altitude encoder value should increase.

*Example 5 – When you move the scope in Azimuth, you note in MODE ENCODER that the Altitude value changes and vice versa.*

You have the encoder cables swapped around. On an encoder cable assembly from Wildcard Innovations, the cable with the white sleeve near the encoder end should go to the Altitude encoder.

#### See also

[MODE ALIGN](#)

[MODE ALIGN STAR](#)

[MODE FIX ALT REF](#)

[SETUP ALT STEPS](#)

[SETUP AZ STEPS](#)

[SETUP ENC TIMING](#)



ARGO NAVIS™

## MODE EQ TABLE

### Function

MODE EQ TABLE allows you to examine and control the equatorial table timer. This menu will only appear if you have set a mount type of EQ TABLE EXACT in [SETUP MOUNT](#).

### About equatorial tables

Equatorial tables, also known as equatorial platforms, allow Alt/Az mounted telescopes, such as Dobsonians, to track the stars. The table causes the telescope riding upon it to rotate around a virtual polar axis. In order to accurately track the apparent motion of the sky, the table must be precisely polar-aligned. ARGO NAVIS™ also requires the table to be accurately polar-aligned.

Tables are driven at a sidereal rate (see [Glossary](#)) by their own internal motor. They have a 'start' position and an 'end' position. Normally, the table is brought to its start position, the table's tracking motor is switched on and the table slowly turns until it can move no further when it reaches its end position. The table is then reset back to its precise start position and tracking is commenced once again. Most tables allow approximately 30 to 80 minutes of tracking time before they require to be reset.

### Using ARGO NAVIS™ with equatorial tables

In order for it to make allowance for the telescope's rotation around a virtual polar

axis, ARGO NAVIS™ has an in-built equatorial table timer.

You need to ensure that the table has a mechanically reproducible start position.

The following "rules" govern the use of ARGO NAVIS™ with an equatorial table.

1. Ensure that the table is accurately polar-aligned.
2. Always start the table from the mechanically reproducible start position.
3. Whenever the table is switched on from this start position, you should simultaneously start the ARGO NAVIS™ equatorial table timer. How to set the timer running is explained further below. If you are not confident that you performed the two operations simultaneously, simply reset the table and timer and try again.
4. When the table reaches its end position, at your convenience, you should stop the ARGO NAVIS™ equatorial table timer. There is no urgency in stopping the timer when the table reaches the end position.
5. To reset the table, bring it back, at your leisure, to the precise mechanically reproducible start position.
6. Once the table begins tracking from its start position again, you should again simultaneously start the ARGO NAVIS™ equatorial table timer.



7. Whenever you perform an [alignment](#) operation and the table is stopped, the ARGO NAVIS™ equatorial timer should be in the stopped state and the table must be parked at its start position.
8. Whenever you perform an alignment and the table is moving, the ARGO NAVIS™ equatorial table timer should have been started at the precise time the table was started from the start position.
9. The [FIX ALT REF](#) step can be performed either when the table is stationary or moving. The [FIX ALT REF](#) angle should be set exactly the same as if telescope were not on top of the table at all. See [MODE FIX ALT REF](#) for a full explanation of the important altitude encoder reference point.

If the above rules are followed, then there is no requirement to re-align ARGO NAVIS™ each time the table is reset.

### Using MODE EQ TABLE

The ARGO NAVIS™ equatorial table timer can be started or stopped using MODE EQ TABLE. The amount of time that has elapsed since the table was started and the amount of remaining time before it will require resetting can be examined as well.

Enter MODE EQ TABLE by spinning the **DIAL** in the top-level menu and pressing **ENTER** when you see –

### MODE EQ TABLE

Assuming you have not already set the equatorial timer running, the display might show -

EQ TBL ELAPSED  
00:00:00.0 STOP

The displayed time is in sidereal hours:minutes:seconds.decimal seconds format. See the [Glossary](#) for a description of sidereal time. To start the TIMER, press **ENTER**. The timer will begin counting upwards and the word **START** will briefly appear on the display before being replaced by the word **RUN**. For example –

EQ TBL ELAPSED  
00:01:05.3 RUN

indicates that 1 sidereal minute and 5.3 sidereal seconds have elapsed. By turning the **DIAL** one detent 'click', the remaining time can be shown in terms of a sidereal rate thus -

EQ TBL REMAINING  
00:58:44.7 RUN

The remaining time display counts down from the EQ TABLE ALARM TIME value set in [SETUP EQ TABLE](#). When the remaining time reaches 00:00:00.0, the equatorial table timer will continue to run but the remaining time displayed will decrement no further. If EQ TABLE SOUND ALARM has been set to ON in [SETUP EQ TABLE](#), a brief audio alarm will be sounded.

Turning the **DIAL** one click while in the REMAINING time mode returns the display to show the ELAPSED time.



To stop and reset the equatorial table timer if it is running, press **ENTER**. To restart the timer, press **ENTER** again.

At any point, **EXIT** can be pressed and ARGO NAVIS™ will return to the top-level menu. The equatorial table timer and alarm feature will continue to operate in the background if the timer was left running.

### Examples

*Example 1 – You would like to perform an alignment while the table is stopped.*

Move the table to its start position, enter MODE EQ TABLE and ensure that the equatorial table timer is stopped. Perform your [FIX ALT REF](#) step and two star alignment as normal.

*Example 2 – Assume that the table and timer were both started earlier in the night and are still running and that you would now like to perform an alignment.*

Perform a FIX ALT REF step or and/or alignment as, whilst the table and timer is still running. ARGO NAVIS™ provides you with the flexibility to perform an alignment either when the table & timer are stopped or as in this case, when the table and timer is running.

*Example 3 – You would like to GUIDE to an object while the table is stopped.*

Move the table to its start position, enter MODE EQ TABLE and ensure that the timer is stopped. GUIDE to the object as normal.

*Example 4 – You would like to GUIDE to an object while the table is running.*

Ensure that the equatorial table timer was set running simultaneously with when the table was set running from its start position. GUIDE to the object as normal.

*Example 5 – You would like to determine the amount of time your table tracks for before requiring resetting. In subsequent runs, you would like ARGO NAVIS™ to provide an audible alarm to warn you when it is time to reset the table.*

Ensure that the equatorial table timer was set running simultaneously with when the table was set running from its start position. Place the unit in MODE EQ TABLE and observe the elapsed time display. When the table reaches the end of its tracking run, note the amount of elapsed time and enter that value into the EQ TABLE ALARM setting in [SETUP EQ TABLE](#). Ensure that EQ TABLE SOUND ALARM has been set to ON in [SETUP EQ TABLE](#), so that a brief audio alarm will be sounded on subsequent runs.

### See also

[MODE ALIGN](#)

[MODE ALIGN STAR](#)

[MODE FIX ALT REF](#)

[SETUP EQ TABLE](#)

[SETUP MOUNT](#)



ARGO NAVIS™

## MODE FIX ALT REF

### Function

MODE FIX ALT REF allows you to define the altitude encoder reference point.

For mounts that require you to align on two objects (See [SETUP MOUNTS](#)), a FIX ALT REF step is essential and vitally important to the pointing accuracy you will achieve.

To understand FIX ALT REF and why it is so important, some background is required.

The encoders that are fitted to your telescope are known as “incremental encoders”. They send out electrical pulses, or “steps”, whenever they are rotated. ARGO NAVIS™ keeps count of these steps as the encoder is rotated back and forth. Since you tell ARGO NAVIS™ what the resolution of each encoder is in SETUP ALT STEPS and SETUP AZ STEPS, it can deduce through what angle an encoder has turned.

However, the incremental encoders have no inherent “zero degree point”. They simply send out pulses and unless ARGO NAVIS™ is told where the starting point is, all angles that it measures are only relative. It turns out that ARGO NAVIS™ never needs to know the “zero degree point” of the Azimuth encoder. However, for the Altitude encoder, some way of referencing the “zero degree point” is vitally important. This is the job of MODE FIX ALT REF.

If you look at the following figure of a telescope on an Altitude/Azimuth (Alt/Az)

mount, you will see that it has three axes –

- An Altitude axis
- An Azimuth axis
- An Optical axis

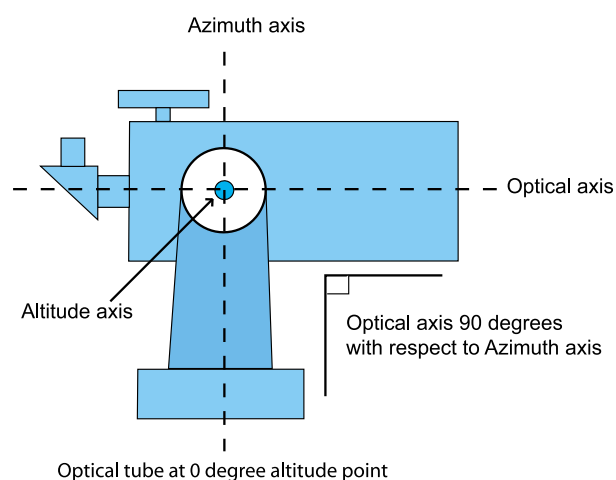
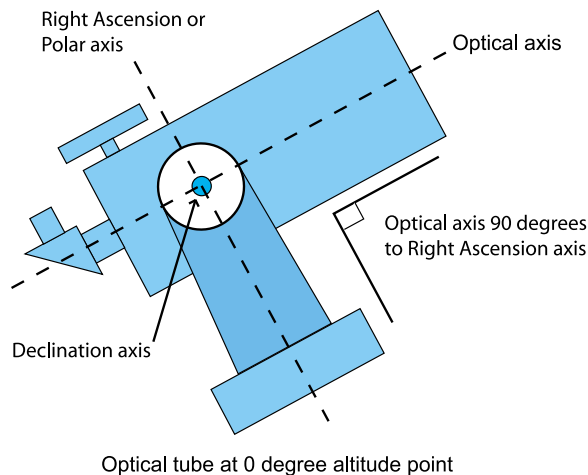

**Figure 8**

The Altitude and Azimuth axes were, hopefully, made perpendicular (right angles, or 90°) to each other when the telescope was manufactured. The optical axis, however, can be moved freely up and down.

The same is true of an equatorial mount. In fact an equatorial mount is essentially an Alt/Az mount that has been tilted to match the local latitude. If you look at the following figure of a telescope on an equatorial mount, you will see it also has three axes –

- A Right Ascension or Polar axis
- A Declination axis
- An Optical axis



**Figure 9**

What is true both in the case of an Alt/Az mount and an equatorial mount, is that when the Optical axis is perpendicular (right angles, or 90°) to the Azimuth or Right Ascension axis, that point corresponds to the Altitude encoder being at its “zero degree point”. MODE FIX ALT REF lets you tell ARGO NAVIS™ where the Altitude encoder “zero degree point” is. Establishing this point is vital to the proper performance of ARGO NAVIS™. A change of even the smallest fraction of a degree can affect your guiding accuracy for better or for worse. Doing so may not show a change in the WARP factor, which is only measuring the difference between the angular distance between two objects and the angular distance the telescope apparently moved.

The utility of MODE FIX ALT REF is such that it allows you to choose what altitude position to put the optical tube in and then

to specify what angle that corresponds to. Specifically it allows you the following choices –

- To put the tube at the 0° altitude point
- To put the tube at the 90° altitude point
- To put the tube at any altitude point that corresponds to an angle that you specify

Examples of the tube being at the 0° altitude point have already been illustrated above. An example of a tube being at the 90° is shown here –

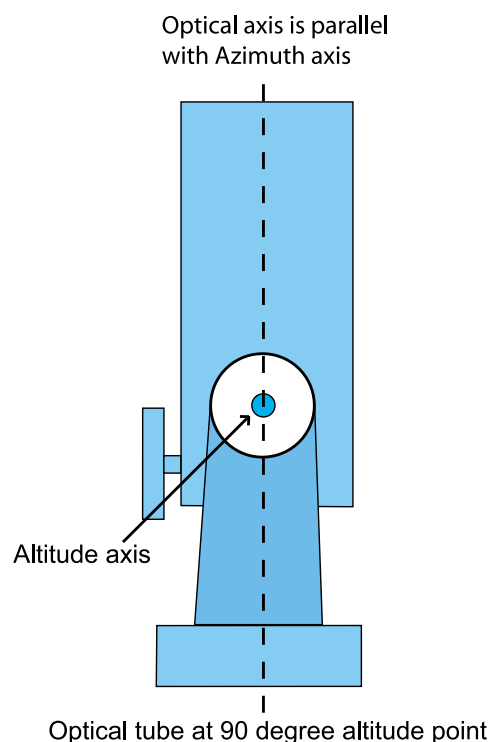

**Figure 10**



A good example of the utility of being able to specify your own angle is found in the case of some Dobsonian telescopes. Many have a mechanical stop, such as the “back-board” that prevents you from positioning the scope beyond the zenith. This “stop position” can be exploited to provide a convenient FIX ALT REF “reference point”. By experimentation or direct measurement, you should be able to determine what angle the scope is at in altitude when it is parked at this stop position. It will probably be close to 90° but maybe not exactly so. You can then program this angle to be your FIX ALT REF “reference point” (See [SETUP ALT REF](#)). You would then start your observing session by parking the scope at that position and performing a FIX ALT REF step at that point.

For Alt/Az and Fork mounts (but not German Equatorials), MODE FIX ALT REF also offers an additional mode called “AUTO ADJUST” which can be used in conjunction with a user specified angle. In this case you only need to specify the angle within a degree or so. Then when you perform an alignment, ARGO NAVIS™ will perform a computation based on the sighting of the two alignment objects and attempt to adjust the reference point that you provided.

However, for German Equatorials (GEMs), “AUTO ADJUST” cannot be used. This means the setting of the reference point must be done with some precision.

### Using MODE FIX ALT REF

You will not see the MODE FIX ALT REF menu if you have selected a mount type of FORK EXACT ALIGN or GEM EXACT ALIGN.

Otherwise Enter MODE FIX ALT REF by spinning the **DIAL** in the top-level menu and pressing **ENTER** when you see –

MODE FIX ALT REF

appear on the display. By spinning the **DIAL**, you can then cycle through the following choices –

ALT REF= 90°  
AUTO ADJUST OFF

ALT REF= 90°  
AUTO ADJUST ON

ALT REF=+0.000 \*  
AUTO ADJUST ON

ALT REF=+0.000 \*  
AUTO ADJUST OFF

\* The angle reported in the last two displays might be different for you. This angle is the user specified angle that you can set in [SETUP ALT REF](#).

Once you have selected the desired reference angle, move your scope in altitude to that position, then press **ENTER**.

If you have not performed any alignments, the bottom line of the display will briefly show –

WARP=ALT FIX OK

If you have performed an alignment, the bottom line of the display will briefly





show a WARP factor. See [MODE ALIGN STAR](#) for an explanation. You may re-perform a MODE FIX ALT REF step at any time.

Note that if you have non-zero terms in the [SETUP MNT ERRORS/SET ERROR VALUES/IN USE NOW](#) submenu, rather than the word

WARP

appear, the display will show the word –

∂WARP

This acts a reminder that you have non-zero mount terms and an associated pointing model in place.

When you have finished, press **EXIT**. If you have changed the selection from what it originally was, the word **SAVING ...** will appear briefly on the bottom line as ARGO NAVIS™ stores the new setting into its memory (EEROM device). The display will then return to the top-level menu –

MODE FIX ALT REF

Tip: Sometimes it is instructive to examine MODE ENCODER after you have performed a FIX ALT REF operation. (See [MODE ENCODER](#).) If you examine the altitude angle in MODE ENCODER angle mode, it should now be the same value as was just set with the FIX ALT REF operation. Keep in mind if you had AUTO ADJUST ON set, then the angle might have been automatically adjusted.

Note: AUTO ADJUST ON may not always be able to compute an adjustment angle for some alignments, particularly on fork mounted scopes. In these circumstances, the WARP factor will be non-zero and suffixed with an (X) on the bottom line of the display. If this should happen, choose another object to align on.

### Examples

*Example 1 – You want a better estimate for the vertical stop position angle on your Dobsonian.*

You move your Dobsonian scope to its vertical stop position. You have entered a value of +90.000° in [SETUP ALT REF](#) and have performed a FIX ALT REF operation with AUTO ADJUST ON with the scope at that position. You then perform a two-star alignment using [MODE ALIGN STAR](#). You determine that the scope's pointing accuracy is very good. You move the scope back to the stop position and examine the altitude reading in the angle display mode of [MODE ENCODER](#). The angle reads +89.67°. AUTO ADJUST ON has compensated it from the original +90°. After some more star alignment trials, you average your readings and deduce that the stop position is pretty nearly +89.67°. You enter that value into [SETUP ALT REF](#) and use that value whenever you start your observing sessions from then on.

### See also

[MODE ALIGN](#)

[MODE ALIGN STAR](#)

[SETUP ALT REF](#)

[SETUP MNT ERRORS](#)



ARGO NAVIS™

## MODE IDENTIFY

### Function

MODE IDENTIFY allows you to attempt to identify an unknown object or to locate the nearest object that is of interest.

In either case, ARGO NAVIS™ searches its [Catalogs](#) database for the object nearest to where the telescope is pointing.

You can search for particular types of objects and specify a limiting magnitude as well as a particular constellation or diameter of sky together with a minimum angular elevation above the horizon in which to limit the search.

Once an object is identified, you can guide to it by pressing **ENTER**.

Pressing **ENTER** again will give you detailed information about the object.

Note: MODE IDENTIFY assumes that you have performed a valid alignment. If you wish to identify ASTEROIDS, COMETS or PLANETS it is also assumed that the current date and time have been set in [SETUP DATE/TIME](#). If you wish to identify SATELLITES or to filter objects that are only at or above a specified angular elevation above the local horizon, it is further assumed that your location, in particular your current latitude and longitude, have been set in [SETUP LOCATION](#).

For identifying ASTEROIDS, COMETS, SATELLITES and USER objects, it is assumed you have [loaded](#) the appropriate catalog.

### Using MODE IDENTIFY

Spin the **DIAL** in the top-level menu until you see -

**MODE IDENTIFY**

then press **ENTER**.

If a valid alignment has not been performed, you will see the following warning message -

**TWO SIGHTINGS ARE REQUIRED. FIX  
ALT REF MAY BE REQUIRED.  
WARNING - DISPLAYED VALUES MAY  
NOT BE VALID**

Otherwise the top line of the display will prompt you with a message such as -

**FIND ANY OBJECT**

where the words **ANY OBJECT** will be flashing.

By spinning the **DIAL**, you can change the flashing value to any of the following -

- **ANY OBJECT** (however, does not include artificial satellites)
- **ASTERISM** (groups of stars)
- **ASTEROID** (assuming your ARGO NAVIS™ has an [asteroid catalog](#) loaded)
- **BRIGHT NEBULA** (such an emission or reflection nebula)
- **COMET** (assuming your ARGO NAVIS™ has a [comet catalog](#) loaded)



ARGO NAVIS™

- **DARK NEBULA**
- **DOUBLE STAR**
- **GALAXY**
- **GALAXY CL** (Galaxy Clusters)
- **GLOBULAR CL** (Globular Clusters)
- **MESSIER** (objects from the Messier Catalog)
- **NEBULA** (either a bright or dark nebula)
- **NON STELLAR** (any object that is not a star nor an artificial satellite)
- **OPEN CLUST** (Open Clusters)
- **PLANET** (within our own Solar System)
- **PLANETARY N** (Planetary Nebula)
- **POPULAR** (Objects with popular names, along with Messier objects and planets)
- **SATELLITE** (Artificial satellites assuming your ARGO NAVIS™ has a [satellite catalog](#) loaded)
- **STAR**
- **TRIPLE STAR**
- **USER OBJECT** (assuming you have loaded [user defined objects](#) into the USER catalog)
- **VARIABLE ST** (Variable stars)

Once you have selected the type of object you are interested in, press **ENTER**. ARGO NAVIS™ will then prompt you with a message such as -

**FAINTEST MAG ANY**

where the word **ANY** is flashing.

By spinning the **DIAL**, you can specify the limiting magnitude to eliminate objects from the search that might be too faint for your circumstances.

The limiting magnitude values range from -6 (very bright) to +16 (very faint) along with the special entry of **MAG ANY**. If, for example, you select a value of 10, then only objects with a limiting value of 10 or brighter will be considered.

**NOTE: Not all objects within the ARGO NAVIS™ catalogs have a defined magnitude. These objects will only be found if the limiting magnitude is set to MAG ANY, irrespective of how bright the object's magnitude might really be. For example, to find DARK NEBULAE or SATELLITES, always choose a limiting magnitude of MAG ANY.**

Once you have selected the limiting magnitude, press **ENTER**. ARGO NAVIS™ will then prompt you with a message such as -

**IN ANY CONSTEL**

where the letter 'A' in **ANY** will be flashing. By using the **DIAL** and the **ENTER** button, you can use the *Intelligent Editing System™* to enter the name of any constellation in which to limit the search or to chose the special entry of **ANY CONSTEL**. By turning the **DIAL** clockwise (+), the letter at the flashing cursor position will alphabetically increase. By turning the **DIAL** anti-clockwise (-), the letter will decrease. 'Wrapping' occurs when the 'maximum' letter is displayed and the **DIAL** is turned



clockwise or when the 'minimum' letter is displayed and the **DIAL** is turned anti-clockwise. Spell out the name of the constellation or the special entry **ANY CONSTEL** by using the **DIAL** and using the **ENTER** button to advance the cursor to the next editable field. The *Intelligent Editing System*<sup>®</sup> will only prompt you with valid names.

When there are no more fields to edit, press **ENTER**.

If the special entry of **ANY CONSTEL** was selected, **ARGO NAVIS**<sup>™</sup> will prompt you with a message such as -

**WITHIN 360° ARC**

where the number '3' will be flashing. By using the **DIAL** and **ENTER** button, you can use the *Intelligent Editing System*<sup>®</sup> to enter a value between 1° to 360°. This represents an angular diameter in which to limit the search, the centre point of the area being the RA/Dec co-ordinate location at which the scope is currently pointing. For example, if the scope were pointing at the zenith, an entry of 180° would select only objects in the sky above the horizon and an entry of 360° would select all objects, even those currently below the horizon. During partly cloudy nights, pointing your scope at clear openings (popularly known to some as 'sucker holes') and limiting the **WITHIN** angle to an appropriate value will constrain you to finding objects within the opening.

When using the *Intelligent Editing System*<sup>™</sup> to input a **WITHIN** diameter angle, consider only one digit at a time. For example, if you want to select an angle of 15°, turn the **DIAL** until the first

digit is blank (a flashing block cursor will display) then press **ENTER**, make the second digit a 1, then press **ENTER**, make the third digit a 5, press **ENTER** again and you are done.

Once a constellation or **WITHIN** diameter has been specified, **ARGO NAVIS**<sup>™</sup> will prompt you with a message such as -

**HORIZON MASK OFF**

where the word '**OFF**' might be flashing. If it is not flashing then you have not specified your location in [SETUP LOCATION](#). If it is flashing, by spinning the **DIAL** you can specify an angle in the range 0° to 30°. This represents an angular elevation above the computed local horizon. Only objects that match the other selected criteria that are also at the specified angular elevation or higher will be considered in the search. By leaving the selection to **OFF** then objects both above and below the horizon will be considered.

Once you have specified any horizon mask filtering, pressing **ENTER** again will cause **ARGO NAVIS**<sup>™</sup> to search continually for the closest object that meets the selection criteria. Initially, you will see -

**SEARCHING**

When the first search pass is completed, the top line of the display will show the name of the closest object that meets the selection criteria and the bottom line of the display will show the word **FOUND**. For example -



ARGO NAVIS<sup>™</sup>

**ANDROMEDA GALAXY  
FOUND**

If no object meets the selection criteria, this message will be displayed –

**NO MATCH  
FOUND**

If **NO MATCH** appears, press **EXIT** to leave MODE IDENTIFY. You may then consider re-entering MODE IDENTIFY and modifying your search criteria.

If an object has been found, either pressing **ENTER** or turning the **DIAL** one 'detent' click will cause **ARGO NAVIS™** to 'lock' that object into **GUIDE** mode. The name of the object will appear in the top line of the display and guiding information will appear in the bottom line. Move the telescope to find that object. For example, if the display reads -

**NGC 1407  
GUIDE 101→25↓**

this means the telescope should be moved 101° in azimuth and 25° in altitude to locate NGC 1407. The arrows represent a relative movement.

For example, if the → arrow is displayed, even though the arrow points to the right, whether one moves the telescope to the right or to the left is dependent on several factors according to your setup. If you wish to change the default direction sense of one or both arrows, you can do so by changing the settings in [SETUP GUIDE MODE](#). In any case, you should move the telescope in the direction that causes the angle to become smaller. As the telescope is

moved, the display continually updates the angles and changes the direction arrows if the object is passed. When an angle less than 10° is displayed, the arrow also acts as a decimal point. For example, 5↓3 means 5.3°.

Generally you might find it is easier to move the telescope in one axis at a time. When the telescope is at the correct position, the bottom line of the display will show -

**NGC 1407  
GUIDE 0.0 0.0**

If a proper alignment has been performed, the object should appear within the field of view of a moderate power eyepiece (for example one that gives a field of about 30 arc minutes). If objects do not appear consistently within the field of view, you may want to perform a re-alignment or review the section [Factors that affect pointing accuracy](#).

At any time during **GUIDE** mode, if you press **ENTER**, a scrolling description of the object is given. Typical descriptions include the full name of the object, other popular names the object might be known by, what constellation the object is in, the size of the object, the visual magnitude of the object, its surface brightness, in the case of stars its spectral luminosity class, in the case of many double stars their separation, in the case of many galaxies its abbreviated Hubble morphology, the object's Right Ascension and Declination, whether it is currently above or below the horizon and what volume and page of the default atlas the object would appear on (See [SETUP ATLAS](#)). While the description is scrolling (to change the default scroll rate, see [SETUP SCROLL](#)), you can press





**EXIT** or **ENTER** to have ARGO NAVIS™ go back to GUIDE mode. Or you can wait until the description has completed scrolling and ARGO NAVIS™ will automatically return to GUIDE mode. If you move the **DIAL** while the description is scrolling, manual scroll mode is entered.

Turning the **DIAL** clockwise scrolls the message forward for convenient reading at your leisure, whilst turning the **DIAL** counter-clockwise scrolls the message in reverse. By pressing **EXIT** or **ENTER** while in manual scroll mode, ARGO NAVIS™ will return to GUIDE mode.

Note that when SAMPLE MODE is ON, in the [SETUP MNT ERR/ACQUIRE DATA](#) submenu, rather than a scrolling description immediately appearing, a new submenu appears.

In this case, by spinning the **DIAL** a detent 'click' at a time, the bottom line of the display can be alternated as follows –

- DESCRIPTION
- SAMPLE MNT ERROR

If you want to view the description of the object, spin the **DIAL** until the word DESCRIPTION appears and then press **ENTER**. If you want to sample the position of an object as part of a pointing test, spin the **DIAL** until the words SAMPLE MNT ERROR appears and then press **ENTER** (See [SETUP MNT ERRORS](#) for details).

While in GUIDE mode, if either **EXIT** is pressed or the **DIAL** is turned one 'detent' click, ARGO NAVIS™ will return to continually searching for the closest object that meets your criteria.

If **EXIT** is pressed again, ARGO NAVIS™ will exit from MODE IDENTIFY.

One feature of MODE IDENTIFY is that it 'remembers' the last selections you made. This includes the type of object to find, the limiting magnitude, the **HORIZON MASK** setting and if you chose **ANY CONSTEL**, the **WITHIN** diameter. Thus when you re-enter MODE IDENTIFY those last selections will become the default values. If you had chosen a particular constellation in which to limit the search, MODE IDENTIFY will prompt you with the name of the constellation that your telescope is currently pointing to as the default constellation selection. ARGO NAVIS™ will return the values to the system default values when the unit is switched off and then back on.

The last object found in MODE IDENTIFY automatically becomes the Current Object. That means that it will appear as the alignment object when entering MODE ALIGN and will be the default object when entering MODE CATALOG.

### **Below horizon indication**

Whenever you are about to locate an object you may want to automatically determine if it is below your local horizon or not.

To do so, ensure that your time zone, date and local time is correctly set in [SETUP DATE/TIME](#), that your latitude and longitude are correctly set in [SETUP LOCATION](#) and that in [SETUP GUIDE MODE](#) you have set GUIDE BELOW HORZ to H INDICATOR=ON.

For example, if the display showed –



GRUS QUARTET  
GUIDE 19→132↓H

the H symbol at the end of the second line indicates that the GRUS QUARTET is currently beneath your local horizon.

If you specified the HORIZON MASK to be anything but OFF, you should never see any objects appearing with the H indicator.

### Examples

FIND GLOBULAR CL  
FAINTEST MAG ANY  
IN CENTAURUS  
HORIZON MASK OFF

might result in -

NGC 5286  
FOUND

Pressing **ENTER** will take you into GUIDE mode -

NGC 5286  
GUIDE 25← 3↑2

This is prompting you to move the scope 25° in azimuth and 3.2° in altitude in order to locate the object.

FIND POPULAR  
FAINTEST MAG +11  
IN CETUS  
HORIZON MASK OFF

might result in -

CETUS A  
FOUND

Either pressing **ENTER** or turning the **DIAL** one 'detent' click will lock that object into GUIDE mode -

CETUS A  
GUIDE 5→0 7↑3

Pressing **ENTER** again will display scrolling information about the object. While the text is scrolling, you can enter manual scroll mode by moving the **DIAL**.

CETUS A ALSO KNOWN AS M77 ALSO  
KNOWN AS NGC 1068 GALAXY IN  
CETUS SIZE=7.1'x6.0' MAG=8.8  
SB=12.9 MORPH=(R)SA(rs)b  
M77. BRIGHT SEYFERT RA=02:42:39  
DEC=-00°00'50" J2000.0 ABOVE  
HORIZON MSA=VOL I 262

Pressing **EXIT** will return you to GUIDE mode -

CETUS A  
GUIDE 0→0 0↑0

Pressing **EXIT** again will return you to search mode -

CETUS A  
FOUND

Pressing **EXIT** again will return you to the top-level menu -

MODE IDENTIFY

### See also

[MODE ALIGN](#)

[MODE ALIGN STAR](#)

[MODE CATALOG](#)

[MODE TOUR](#)

[SETUP DATE/TIME](#)

[SETUP GUIDE MODE](#)



ARGO NAVIS™



## MODE RA DEC

### Function

MODE RA DEC allows you to determine the position of the telescope in a Right Ascension - Declination co-ordinate system. These co-ordinates are reported with respect the International Celestial Reference Frame (ICRF) which for practical purposes can be regarded as the same as the FK5 J2000.0 co-ordinate system. This mode assumes that you have performed a valid alignment.

### Using MODE RA DEC

Right Ascension (RA) is expressed in hours:minutes:seconds of time where hours range from 0 to 24. Declination (Dec) is expressed as an angle in degrees and values range from  $-90^{\circ}$  to  $+90^{\circ}$ , with  $90^{\circ}$  at the North Celestial Pole (NCP),  $-90^{\circ}$  at the South Celestial Pole (SCP) and  $0^{\circ}$  at the Celestial Equator.

Right Ascension can be displayed either as hours:minutes:seconds or as hours:minutes.decimal minutes, depending upon the user's preference. Declination is always displayed as degrees and arc minutes.

Enter MODE RA DEC by spinning the **DIAL** in the top-level menu and pressing **ENTER** when you see -

MODE RA DEC

The display will show the telescope's Right Ascension on the left and the telescope's Declination on the right. If a

valid alignment has not been performed, a scrolling warning message will be displayed, possibly similar to this one -

TWO SIGHTINGS ARE REQUIRED. FIX  
ALT REF MAY BE REQUIRED.  
WARNING - DISPLAYED VALUES MAY  
NOT BE VALID.

Otherwise, the bottom line of the display shows the name of the constellation that the telescope is currently pointing towards. For example -

12:26:51 -63°07'  
CRUX

shows that the scope is at 12 hours, 26 minutes and 51 seconds in RA and  $-63$  degrees, 7 arc minutes in declination within the constellation Crux. If the **DIAL** is rotated one detent 'click', the Right Ascension will be shown in hours:minutes.decimal minutes format. For example -

12:26.8 -63°07'  
CRUX

Pressing **ENTER** will briefly display the page number of the default atlas (see [SETUP ATLAS](#)) that covers the area of sky the telescoping is pointing to.

12:26.8 -63°07'  
MSA=VOL II 1002

In this case, Millennium Star Atlas™ Volume II page 1002.



ARGO NAVIS™

As you move the scope, the displayed Right Ascension, Declination values and constellation name will update in real-time.

For a stationary telescope, Right Ascension constantly changes as a function of time as the Earth rotates. This rate of time is known as a Sidereal Rate.

If your scope is accurately polar aligned and the clock drive on your scope is switched on, you might notice a cyclic pattern whereby the values of RA appear to slowly increase, then suddenly decrease. The reason for this is the finite resolution of your azimuth (Right Ascension) encoder. For example, a 10,000-step encoder has, at best, a resolution of 2.16 arc minutes. ARGO NAVIS™ has an internal sidereal clock that is used to update the Right Ascension value. As the clock-drive on your scope moves it around in azimuth (Right Ascension), periodically the azimuth encoder will step. When this occurs, the displayed Right Ascension value will appear to briefly “jump” backwards.

Keep in mind for non-polar aligned scopes, moving them purely in azimuth or altitude will result in both Right Ascension and Declination values changing.

The effects of precession and nutation cause an apparent displacement of the stars when viewed from the Earth. (See [Glossary](#).) However, it is the current convention of the International Astronomical Union (IAU) that celestial co-ordinates are reported with respect the fixed International Celestial Reference Frame (ICRF) which is for practical

purposes the same as the previous FK5 J2000.0 co-ordinate system. This co-ordinate system remains invariant to the effects of precession and nutation and so by IAU convention, all object positions are reported according to where an object happened to be at midday UTC on 1 Jan 2000. ARGO NAVIS™ follows the IAU convention and displays the RA and Dec values with respect the ICRF.

Refraction is the bending of light rays through the atmosphere that causes objects close to the horizon to appear higher in altitude than they actually are. If you have accurately entered the date and time in [SETUP DATE TIME](#), entered your location and in particular your latitude and longitude in [SETUP LOCATION](#) and have turned refraction modelling on in [SETUP REFRACTION](#), this effect will be taken into account when displaying RA and Dec values.

To leave MODE RA DEC, press **EXIT**. ARGO NAVIS™ saves the last Right Ascension display format you used in memory (EEROM device).

#### See also

[MODE ALIGN](#)

[MODE ALIGN STAR](#)

[SETUP DATE/TIME](#)

[SETUP LOCATION](#)

[SETUP REFRACTION](#)



ARGO NAVIS™

## MODE SETUP

### Function

MODE SETUP provides the entry point to the various SETUP sub-menus.

### Using MODE SETUP

Spin the **DIAL** in the top-level menu until you see -

**MODE SETUP**

then press **ENTER**. The display will then show the name of the menu that appeared when you last exited from MODE SETUP since power-on.

By spinning the **DIAL**, the various SETUP menus can be displayed. The menus appear in alphabetical order as the **DIAL** is spun clockwise and wrap at the last menu. Note that the SETUP EQ TABLE menu will not appear unless you have set a mount type of EQ TABLE EXACT in [SETUP MOUNT](#)

The SETUP menus are –

- **SETUP ALIGN PICK**
- **SETUP ALT REF**
- **SETUP ALT STEPS**
- **SETUP ARCHIVE**
- **SETUP ATLAS**
- **SETUP AZ STEPS**
- **SETUP BRIGHTNESS**
- **SETUP CONTRAST**
- **SETUP DATE/TIME**
- **SETUP DEBUG**

- **SETUP DEFAULTS**
- **SETUP ENC TIMING**
- **SETUP EQ TABLE**
- **SETUP GOTO**
- **SETUP GUIDE MODE**
- **SETUP LCD HEATER**
- **SETUP LOAD CAT**
- **SETUP LOCATION**
- **SETUP MOUNT**
- **SETUP MNT ERRORS**
- **SETUP REFRACTION**
- **SETUP SCRATCH**
- **SETUP SCROLL**
- **SETUP SERIAL**

### See also

- [SETUP ALIGN PICK](#)
- [SETUP ALT REF](#)
- [SETUP ALT STEPS](#)
- [SETUP ARCHIVE](#)
- [SETUP ATLAS](#)
- [SETUP AZ STEPS](#)
- [SETUP BRIGHTNESS](#)
- [SETUP CONTRAST](#)
- [SETUP DATE/TIME](#)
- [SETUP DEBUG](#)
- [SETUP DEFAULTS](#)
- [SETUP ENC TIMING](#)
- [SETUP EQ TABLE](#)
- [SETUP GOTO](#)
- [SETUP GUIDE MODE](#)
- [SETUP LCD HEATER](#)
- [SETUP LOAD CAT](#)
- [SETUP LOCATION](#)
- [SETUP MOUNT](#)



ARGO NAVIS™

[SETUP MNT ERRORS](#)  
[SETUP REFRACTION](#)  
[SETUP SCRATCH](#)

[SETUP SCROLL](#)  
[SETUP SERIAL](#)



## MODE SIDEREAL

### Function

MODE SIDEREAL shows you the Local Apparent Sidereal Time (LAST). This mode assumes that the current date and time have been set in [SETUP DATE/TIME](#) and that your location, in particular your current latitude and longitude, have been set in [SETUP LOCATION](#).

The Local Apparent Sidereal Time corresponds to the hour of Right Ascension crossing the local meridian, which is the imaginary north-south circle that passes through the local zenith. The zenith is the point directly overhead.

Knowing the current LAST might be handy, for example, if you wanted to determine the hour of Right Ascension (RA) that is currently overhead, where the sky tends to be darkest.

### Using MODE SIDEREAL

Enter MODE SIDEREAL by spinning the **DIAL** in the top-level menu and pressing **ENTER** when you see –

**MODE SIDEREAL**

The display will show the Local Apparent Sidereal Time (LAST) in the top line and the name of your location that you selected in SETUP LOCATION.

For example –

**LAST 23:48:27**  
**CAPE TOWN**

Indicates that Right Ascension 23:48:27 is crossing your local meridian from your observing site in Cape Town. You might then decide to grab your star charts corresponding to this hour of RA. In this case, you might decide to observe in Sculptor, which would be directly overhead.

To leave MODE SIDEREAL, press **EXIT**.

### See also

[SETUP DATE/TIME](#)

[SETUP LOCATION](#)



ARGO NAVIS™

## MODE STATUS

### Function

MODE STATUS allows you to examine -

- the status of your ARGO NAVIS™ power source;
- the label name of the current setup you are using
- the unit's internal temperature;
- the firmware version that is currently loaded.

### Using MODE STATUS

Enter MODE STATUS by spinning the **DIAL** in the top-level menu and pressing **ENTER** when you see –

**MODE STATUS**

Then spin the **DIAL** to choose what status information you are interested in. For example, STATUS POWER will tell you whether the unit is being powered by internal batteries or by an external source and whether the voltage level is OK or low. For example -

**STATUS POWER**  
**BAT=LOW**

indicates that the unit is being powered by internal batteries but that they are running low. Whereas –

**STATUS POWER**  
**EXT=OK**

indicates that the unit is being powered externally and that the voltage level is sufficient.

STATUS SETUP will tell you the label name of the current setups. The label name can be set in the [SETUP ARCHIVE](#), LABEL CURRENT submenu. For example –

**STATUS SETUP**  
**LABEL=HECTOR**

indicates you are running the setups for a telescope you nicknamed after the Greek Trojan prince HECTOR.

STATUS THERMAL will tell you the internal temperature of the unit. For example –

**STATUS THERMAL**  
**32.9°C 91.2°F**

shows the temperature both in Celsius and Fahrenheit.

STATUS VERSION will tell you the version of ARGO NAVIS™ firmware you are currently running. For example –

**STATUS VERSION**  
**VERSION=3.0.0**

tells you that you have Version 3.0.0. A newer version of firmware will have a higher version number.

To leave MODE STATUS, press **EXIT**. MODE STATUS remembers what state you last left it in. However, if you power-off the unit, STATUS POWER becomes the default state when you power the unit back on.



**ARGO NAVIS™**



## MODE TIME

### Function

MODE TIME shows you the following -

- Local Time – including the day of the week, day, month and year. The time is shown in 24 hour format.
- Universal Co-ordinated Time (UTC) – including the day of the week, day, month and year. The time is shown in 24 hour format.
- Julian Date – the number of days and decimal fraction of days that have elapsed since Julian day 0 on 1 January 4713 BC Julian.

MODE TIME assumes that the current date and time have been set in SETUP DATE/TIME.

### Using MODE TIME

Enter MODE TIME by spinning the **DIAL** in the top-level menu and pressing **ENTER** when you see –

**MODE TIME**

The display will show you either the Local, UTC or Julian date/time depending upon what state you last exited MODE TIME since you powered on ARGO NAVIS™.

For example –

**LOCAL 13:15:47**  
**TUE 20 APR 2017**

Shows the local time in hours:minutes:seconds format on the top line and the date on the bottom. By turning the **DIAL** clockwise one detent 'click', the displayed time format can be changed. For example –

**UTC 03:15:50**  
**TUE 20 APR 2017**

shows the current UTC time and date. The UTC time is what was once known as Greenwich Mean Time (GMT). By again turning the **DIAL** clockwise one detent 'click', the format can be changed to show the Julian Date. For example –

**JULIAN DATE**  
**2458099.63587**

shows the current Julian Date including a decimal fraction of days.

Knowing the Julian Date is useful to variable star enthusiasts who, by convention, report their observations by quoting the Julian Date.

Continuing with the example, if the **DIAL** is turned clockwise one detent 'click' again, the displayed time will return to **LOCAL** format.

To leave MODE TIME, press either **EXIT** or **ENTER**.

### See also

[SETUP DATE/TIME](#)

## MODE TIMER

### Function

MODE TIMER provides you with stopwatch functionality. You can **START**, **STOP** and **RESET** the timer. You can display the elapsed time in terms of either a Synodic or Sidereal Rate. A Synodic Rate means 'Sun' time – the familiar rate of time like that which occurs on a wristwatch. Sidereal Rate means 'Star' time – the rate at which stars appear to move across the sky.

### Using MODE TIMER

Enter MODE TIMER by spinning the **DIAL** in the top-level menu and pressing **ENTER** when you see -

**MODE TIMER**

Assuming you have not already set the timer going, the display will show -

**00:00:00.0**  
**SYNODIC RATE**

The displayed time is in hours:minutes:seconds.decimal seconds format. To start the **TIMER**, press **ENTER**. The timer will begin counting upwards and the word **START** will briefly appear on the display before being replaced by the word **RUN**. For example –

**00:56:25.6** **RUN**  
**SYNODIC RATE**

suggests that 56 minutes and 25.6 seconds have elapsed. By turning the **DIAL** one detent 'click', the elapsed time can be shown in terms of a Sidereal rate thus -

**00:56:34.9** **RUN**  
**SIDEREAL RATE**

Turning the **DIAL** again one click returns the display to Synodic rate. To stop the timer press **ENTER**. At that point the elapsed time will be "frozen" on the display and the word **STOP** will appear briefly. For example –

**02:06:12.9** **STOP**  
**SIDEREAL RATE**

indicates an elapsed time of 2 hours, 6 minutes and 12.9 seconds. To reset the timer, press **ENTER** again. The word **RESET** will briefly appear thus –

**00:00:00.0** **RESET**  
**SYNODIC RATE**

Pressing **ENTER** will start the timer again.

While in **MODE TIMER** you may press **EXIT** at any time, including while the timer is running. In this case, the timer will continue to run in the background. When you return to **MODE TIMER** the correct elapsed time will be displayed.



ARGO NAVIS™

## MODE TOUR

### Function

MODE TOUR allows you to tour objects of interest.

You can tour particular types of objects and specify a limiting magnitude as well as a particular constellation or diameter of sky together with a minimum angular elevation above the horizon in which to limit the search.

ARGO NAVIS™ begins the tour by examining where your telescope is initially pointing and then finds the closest object that meets your search criteria.

Having done that, ARGO NAVIS™ automatically enters GUIDE mode. By following the guiding information, you can move your telescope to locate the object.

Pressing **ENTER** in GUIDE mode will give you detailed information about the object, while spinning the **DIAL** clockwise one detent 'click' advances you to the next closest object in the tour and so forth. You can spin the **DIAL** anti-clockwise to backtrack through the tour.

ARGO NAVIS™ flags when you reach the end of a tour by telling you that there are NO MORE OBJECTS.

You can even tour objects that you have loaded into the USER CATALOG.

You can leave a tour at any time, perform other operations and then optionally rejoin the tour from the point at which you were at previously.

The flexibility, power and speed of TOUR MODE allow it to become a real

'work-horse' during your observing sessions.

Note: MODE TOUR assumes that you have performed a valid alignment. If you wish to tour ASTEROIDS, COMETS or PLANETS it is also assumed that the current date and time have been set in [SETUP DATE/TIME](#). If you wish to tour SATELLITES it is further assumed that your location, in particular your current latitude and longitude, have been set in [SETUP LOCATION](#). For touring ASTEROIDS, COMETS, SATELLITES and USER objects, it is assumed you have loaded the appropriate catalog.

### Using MODE TOUR

Point your telescope to the region of the sky in which you would like to begin the tour. Spin the **DIAL** in the top-level menu until you see -

**MODE TOUR**

then press **ENTER**.

The displayed text that appears next will depend upon whether this is the first tour you have undertaken since powering on the unit. The following paragraphs will assume that is so.

If a valid alignment has not been performed, you will see the following warning message -

**TWO SIGHTINGS ARE REQUIRED. FIX  
ALT REF MAY BE REQUIRED.  
WARNING - DISPLAYED VALUES MAY  
NOT BE VALID**



ARGO NAVIS™

Otherwise the top line of the display will prompt you with a message such as -

**FIND ANY OBJECT**

where the words **ANY OBJECT** will be flashing.

By spinning the **DIAL**, you can change the flashing value to any of the following -

- **ANY OBJECT** (however, does not include artificial satellites)
- **ASTERISM** (groups of stars)
- **ASTEROID** (assuming your ARGO NAVIS™ has an [asteroid catalog](#) loaded)
- **BRIGHT NEBULA** (such as an emission or reflection nebula)
- **COMET** (assuming your ARGO NAVIS™ has a [comet catalog](#) loaded)
- **DARK NEBULA**
- **DOUBLE STAR**
- **GALAXY**
- **GALAXY CL** (Galaxy Clusters)
- **GLOBULAR CL** (Globular Clusters)
- **MESSIER** (objects from the Messier Catalog)
- **NEBULA** (either a bright or dark nebula)
- **NON STELLAR** (any object that is not a star nor an artificial satellite)
- **OPEN CLUST** (Open Clusters)
- **PLANET** (within our own Solar System)
- **PLANETARY N** (Planetary Nebula)

- **POPULAR** (objects with popular names, along with Messier objects and planets)
- **SATELLITE** (Artificial satellites assuming your ARGO NAVIS™ has a [satellite catalog](#) loaded)
- **STAR**
- **TRIPLE STAR**
- **USER OBJECT** (assuming you have loaded [user defined objects](#) into the USER catalog)
- **VARIABLE ST** (Variable stars)

Once you have selected the type of objects you are interested in, press **ENTER**. ARGO NAVIS™ will then prompt you with a message such as -

**FAINTEST MAG ANY**

where the word **ANY** is flashing.

By spinning the **DIAL**, you can specify the limiting magnitude to eliminate objects from the tour that might be too faint for your circumstances.

The limiting magnitude values range from -6 (very bright) to +16 (very faint) along with the special entry of **MAG ANY**. If, for example, you select a value of 12, then only objects with a limiting value of 12 or brighter will be considered.

**NOTE: Not all objects within the ARGO NAVIS™ catalogs have a defined magnitude. These objects will only be found if the limiting magnitude is set to MAG ANY, irrespective of how bright the object's magnitude might really be. For example, to find DARK NEBULAE or**



**SATELLITES, always choose a limiting magnitude of **MAG ANY**.**

Once you have selected the limiting magnitude, press **ENTER**. **ARGO NAVIS™** will then prompt you with a message such as -

**IN ANY CONSTEL**

where the letter 'A' in **ANY** will be flashing. By using the **DIAL** and the **ENTER** button, you can use the *Intelligent Editing System™* to enter the name of any constellation in which to limit the search or to chose the special entry of

**ANY CONSTEL**. By turning the **DIAL** clockwise (+), the letter at the flashing cursor position will alphabetically increase. By turning the **DIAL** anti-clockwise (-), the letter will decrease. 'Wrapping' occurs when the 'maximum' letter is displayed and the **DIAL** is turned clockwise or when the 'minimum' letter is displayed and the **DIAL** is turned anti-clockwise. Spell out the name of the constellation or the special entry **ANY CONSTEL** by using the **DIAL** and using the **ENTER** button to advance the cursor to the next editable field. The *Intelligent Editing System™* will only prompt you with valid names.

If the special entry of **ANY CONSTEL** was selected, the **ARGO NAVIS™** will prompt you with a message such as:

**WITHIN 360° ARC**

where the number '3' will be flashing. By using the **DIAL** and **ENTER** button, you can use the *Intelligent Editing System™* to enter a value between 1° to 360°. This

represents an angular diameter in which to limit the tour, the centre point of the area being the RA/Dec co-ordinate location at which the scope was initially pointing when **MODE TOUR** was entered. For example, if the scope were pointing at the zenith, an entry of 180° would select only objects in the sky above the horizon and an entry of 360° would select all objects, even those currently below the horizon. During partly cloudy nights, pointing your scope at clear openings (popularly known to some as 'sucker holes') and limiting the **WITHIN** angle to an appropriate value will constrain you to finding objects within the opening.

When using the *Intelligent Editing System™* to input a **WITHIN** diameter angle, consider only one digit at a time. For example, if you want to select an angle of 15°, turn the **DIAL** until the first digit is blank (a flashing block cursor will display) then press **ENTER**, make the second digit a 1, then press **ENTER**, make the third digit a 5, press **ENTER** again and you are done.

Once a constellation or **WITHIN** diameter has been specified, **ARGO NAVIS™** will prompt you with a message such as -

**HORIZON MASK OFF**

where the word '**OFF**' might be flashing. If it is not flashing then you have not specified your location in [SETUP LOCATION](#). If it is flashing, by spinning the **DIAL** you can specify an angle in the range 0° to 30°. This represents an angular elevation above the computed local horizon. Only objects that match the other selected criteria that are also at the specified



**ARGO NAVIS™**

angular elevation or higher will be considered in the search. By leaving the selection to **OFF** then objects both above and below the horizon will be considered.

Once you have specified any horizon mask filtering, pressing **ENTER** again will cause **ARGO NAVIS™** to begin to search for the closest object that meets the selection criteria. During this time **ARGO NAVIS™** will display this message -

### SEARCHING

When the first search pass is completed, the **ARGO NAVIS™** will either show the name of the closest object that meets the selection criteria or the words **NO MORE OBJECTS** if there are no objects that meet the selection criteria.

If **NO MORE OBJECTS** appears, press **EXIT** to leave **MODE TOUR**. You may then consider re-entering **MODE TOUR** and modifying your search criteria.

If an object is found in the search, **ARGO NAVIS™** automatically enters **GUIDE** mode. The top line of the display will show the name of the closest object that meets the selection criteria and the bottom line of the display will show guiding information. For example -

ABELL 35  
GUIDE 25← 3↑2

means the telescope should be moved 25° in azimuth and 3.2° in altitude to locate Abell 35. The arrows represent a relative movement.

For example, if the ← arrow is displayed, even though the arrow points to the left, whether one moves the telescope to the left or to the right is

dependent on several factors according to your setup. If you wish to change the default direction sense of one or both arrows, you can do so by changing the settings in [SETUP GUIDE MODE](#). In any case, you should move the telescope in the direction that causes the angle to become smaller. As the telescope is moved, the display continually updates the angles and changes the direction arrows if the object is passed. When an angle less than 10° is displayed, the arrow also acts as a decimal point. For example, 3↑2 means 3.2°.

Generally you might find it is easier to move the telescope in one axis at a time. When the telescope is at the correct position, the bottom line of the display will show -

ABELL 35  
GUIDE 0.0 0.0

If a proper alignment has been performed, the object should appear within the field of view of a moderate power eyepiece (for example one that gives a field of about 30 arc minutes). If objects do not appear consistently within the field of view, you may want to perform a re-alignment or review the section [Factors that affect pointing accuracy](#).

At any time during **GUIDE** mode, if you press **ENTER**, a scrolling description of the object is given. Typical descriptions include the full name of the object, other popular names the object might be known by, what constellation the object is in, the size of the object, the visual magnitude of the object, its surface brightness, in the case of stars its spectral luminosity class, in the case of many double stars their separation, in the case of many galaxies



**ARGO NAVIS™**



its abbreviated Hubble morphology, the object's Right Ascension and Declination, whether it is currently above or below the horizon and what volume and page of the default atlas the object would appear on (See [SETUP ATLAS](#)). While the description is scrolling (to change the default scroll rate, see [SETUP SCROLL](#)), you can press **EXIT** or **ENTER** to have the ARGO NAVIS™ go back to GUIDE mode. Or you can wait until the description has completed scrolling and ARGO NAVIS™ will automatically return to GUIDE mode. If you move the **DIAL** while the description is scrolling, manual scroll mode is entered.

Turning the **DIAL** clockwise scrolls the message forward for convenient reading at your leisure, whilst turning the **DIAL** counter-clockwise scrolls the message in reverse. By pressing **EXIT** or **ENTER** while in manual scroll mode, the ARGO NAVIS™ will return to GUIDE mode.

Note that when SAMPLE MODE is ON, in the [SETUP MNT ERR/ACQUIRE DATA](#) submenu, rather than a scrolling description immediately appearing, a new submenu appears.

In this case, by spinning the **DIAL** a detent 'click' at a time, the bottom line of the display can be alternated as follows –

- **DESCRIPTION**
- **SAMPLE MNT ERROR**

If you want to view the description of the object, spin the **DIAL** until the word **DESCRIPTION** appears and then press **ENTER**. If you want to sample the position of an object as part of a pointing

test, spin the **DIAL** until the words **SAMPLE MNT ERROR** appears and then press **ENTER** (See [SETUP MNT ERRORS](#) for details).

While in GUIDE mode, each time the **DIAL** is turned one 'detent' click clockwise, ARGO NAVIS™ will search for the next closest object that meets your selection criteria. When the end of the tour is reached, the display will show –

**NO MORE OBJECTS**

While in GUIDE mode, if the **DIAL** is turned anti-clockwise, you can backtrack through the tour. In this case, while it is searching, ARGO NAVIS™ will briefly display the message –

**BACKTRACKING**

When you can backtrack no further, this message will be displayed –

**START OF TOUR**

At any time in GUIDE mode, if **EXIT** is pressed, ARGO NAVIS™ will exit from MODE TOUR.

One feature of MODE TOUR is that it 'remembers' the last selections you made. This includes the type of object to find, the limiting magnitude, the horizon mask setting and if you chose **ANY CONSTEL**, the **WITHIN** diameter. Thus when you re-enter MODE TOUR those last selections will become the default values. If you had chosen a particular constellation in which to limit the search, MODE TOUR will prompt



ARGO NAVIS™

you with the name of the constellation that your telescope is currently pointing to as the default constellation selection. ARGO NAVIS™ will return the values to the system default values when the unit is switched off and then back on.

Another feature of MODE TOUR is the ability to leave a tour at any point and to then rejoin the tour from that same point you were last at.

If you re-enter MODE TOUR having been on a tour, the top line of the display will prompt you with a message such as -

FIND ANY OBJECT

However, this time the word FIND will be flashing.

By turning the DIAL, you can alternate the flashing value to either -

- FIND
- or
- REJOIN LAST TOUR

By pressing ENTER when the display shows REJOIN LAST TOUR, you will rejoin the tour from the point you were last at. This could be at the start or the end of the tour or at any point in between. You can still search forward or backward through the tour and exit and rejoin it at any time.

Note that the last object found in MODE TOUR automatically becomes the Current Object. That means that it will appear as the alignment object when entering MODE ALIGN and will be the default object when entering MODE CATALOG.

### Below horizon indication

Whenever you are about to locate an object you may want to automatically determine if it is below your local horizon or not.

To do so, ensure that your time zone, date and local time is correctly set in [SETUP DATE/TIME](#), that your latitude and longitude are correctly set in [SETUP LOCATION](#) and that in [SETUP GUIDE MODE](#) you have set GUIDE BELOW HORZ to H INDICATOR=ON.

For example, if the display showed -

MURRELL 1  
GUIDE 18→126↓H

the H symbol at the end of the second line indicates that the planetary nebula MURRELL 1 is currently beneath your local horizon.

If you specified the HORIZON MASK to be anything but OFF, you should never see any objects appearing with the H indicator.

### Examples

#### Example 1

FIND GLOBULAR CL  
FAINTEST MAG ANY  
IN CENTAURUS

might result in -

NGC 5286  
GUIDE 4←0 41↑

This is prompting you to move the scope 4° in azimuth and 41° in altitude in order to locate the object. Now spinning the DIAL clockwise might then show -



OMEGA CENTAURI  
GUIDE 3←5 7↑2

Spinning the DIAL clockwise again might then show –

RUPRECHT 106  
GUIDE 5→2 5↑7

Spinning the DIAL clockwise one more time might then show –

NO MORE OBJECTS

You might then decide to backtrack to take one more look at Omega Centauri. You would turn the **DIAL** anti-clockwise two detent 'clicks' and guide to it once again.

*Example 2*

TOUR POPULAR  
FAINTEST MAG +11  
IN CETUS

might result in -

CETUS A  
GUIDE 4→2 0↑3

You could then guide to it. Pressing **ENTER** again will display scrolling information about the object. While the text is scrolling, you can enter manual scroll mode by moving the **DIAL**.

CETUS A ALSO KNOWN AS M77 ALSO  
KNOWN AS NGC 1068 GALAXY IN  
CETUS SIZE=7.1'x6.0' MAG=8.8  
SB=12.9 MORPH=(R)SA(rs)b  
M77. BRIGHT SEYFERT RA=02:42:39  
DEC=-00°00'50" J2000.0 ABOVE  
HORIZON MSA=VOL I 262

Pressing **EXIT** will return you to GUIDE mode -

CETUS A  
GUIDE 0→0 0↑0

Pressing **EXIT** again will return you to the top-level menu –

MODE TOUR

You might then perform some other operation and then decide to rejoin the tour. Make sure that the display shows –

MODE TOUR

Then press **ENTER**. Turn the **DIAL** until the display shows -

REJOIN LAST TOUR

Then press **ENTER** again. The display will then show something like -

CETUS A  
GUIDE 0→0 0↑0

Which is the point that you were at when you last left the tour.

**See also**

[MODE ALIGN](#)

[MODE ALIGN STAR](#)

[MODE CATALOG](#)

[MODE IDENTIFY](#)

[SETUP DATE/TIME](#)

[SETUP GUIDE MODE](#)

[SETUP MNT ERROR](#)



ARGO NAVIS™

## SETUP ALIGN PICK

### Function

SETUP ALIGN PICK allows you to modify the strategy by which ARGO NAVIS™ chooses which objects to use during alignment.

Irrespective of your mount type (see [SETUP MOUNT](#)), ARGO NAVIS™ always utilizes the last object that you aligned with in a [MODE ALIGN](#) or [MODE ALIGN STAR](#) operation. In the case of polar aligned mounts, this is in fact the only object that is utilized.

In the case of mounts that require at least two objects to align, you can choose whether ARGO NAVIS™ performs an alignment using two objects or, if available, three objects at a time. ARGO NAVIS™ maintains a first-in, first-out, 6-deep 'queue' of objects that you have aligned on. You can specify how 'deep' ARGO NAVIS™ looks in its queue when deciding which objects to utilize to align on.

Keep in mind that setting SETUP ALIGN PICK to always perform a three-object alignment will not necessarily improve your pointing accuracy. In fact, in some circumstances, it could make your pointing worse. **Furthermore, Wildcard Innovations highly recommends that you leave SETUP ALIGN PICK at its default setting and consider using the more powerful features available to you in [SETUP MNT ERRORS](#), which allows you to effectively perform a 'super-alignment'**

**on an arbitrary number of stars (up to 150 at a time).**

The importance of an accurately performed FIX ALT REF step (see [MODE FIX ALT REF](#)) cannot be over-emphasized. For FORK ROUGH ALIGN and ALTAZ/DOBSONIAN mounts, Wildcard Innovations highly recommends you consider using the AUTO ADJUST ON feature when you perform THE FIX ALT REF step.

### Using SETUP ALIGN PICK

Enter the MODE SETUP menu then spin the **DIAL** until you see -

SETUP ALIGN PICK

Press **ENTER** and the display might show something like this -

ALIGN PICK=LAST+  
PICK 1 OF 1 PREV

where the first '1' on the bottom line will be flashing. The words on the top line indicate that ARGO NAVIS™ will always utilize the last object that you aligned on. This is the factory default. In this example, the words on the bottom indicate that for mounts that require more than one alignment object, ARGO NAVIS™ will pick one other object from a one-deep queue. In other words, ARGO NAVIS™ will perform a two-object alignment and will choose the object you just aligned with and the previous one to that.



ARGO NAVIS™

By spinning the **DIAL**, the “PICK” number can be toggled between a ‘1’ and ‘2’. If you were to choose ‘2’, ARGO NAVIS™ will perform a three-object alignment.

Once you have chosen the desired “PICK” number, press **ENTER**. You can then spin the **DIAL** and choose the depth of the queue ARGO NAVIS™ will consider. If the “PICK” number was ‘1’, then the “PREV” number can range from ‘1’ to ‘5’. If the “PICK” number was ‘2’, the “PREV” number can range from ‘2’ to ‘5’. For example –

**ALIGN PICK=LAST+  
PICK 1 OF 5 PREV**

indicates to perform a two-object alignment using the last object and one other from a choice of up to 5 previous objects before that.

In making a decision as to which previous object to choose, ARGO NAVIS™ will pick the one that is the greatest angular distance away from the last one you aligned on. In the case of a three-object alignment, ARGO NAVIS™ will pick the two objects that are furthest away from the last one you aligned on.

To leave SETUP ALIGN PICK, press either **EXIT** or **ENTER**. If the values have changed from what they originally were, ARGO NAVIS™ will briefly display the words -

**SAVING ...**

while it saves your settings into its memory (EEROM device) and then display the message –

## SETUP ALIGN PICK

Note: When there have been insufficient alignments to perform the chosen alignment strategy, ARGO NAVIS™ uses a “fall-back” approach. For example, in the case of a roughly aligned Fork or German Equatorial mount, one FIX ALT REF step and two object alignments are required. However, ARGO NAVIS™ will make various assumptions and perform a partial alignment when the first ALIGN or ALIGN STAR operation is performed. In this case it will assume it is close to polar alignment and utilize the information from the ALIGN operation and the FIX ALT REF step.

Note: At present there is no way of removing an alignment performed on a misidentified object. If an object was correctly identified but it was not centred in the eyepiece when the alignment occurred, simply re-align on it as many times as you like.

Note: It should also be kept in mind that when ARGO NAVIS™ has a choice as to which objects to use for an alignment, their angular separation is time dependent. Though the angular separation of any two objects in the sky at any moment in time is fixed, the rotation of the Earth, however, means their angular separation in terms of aligning on them varies.

### See also

[SETUP DATE/TIME](#)



ARGO NAVIS™

## SETUP ALT REF

### Function

SETUP ALT REF allows you to specify the user-definable angle that will appear as an option in the MODE FIX ALT REF menu (See [MODE FIX ALT REF](#)).

The MODE FIX ALT REF menu has the following choices –

- 0° AUTO ADJUST OFF
- 90° AUTO ADJUST OFF
- The user-defined angle with AUTO ADJUST OFF
- The user-defined angle with AUTO ADJUST ON

Therefore –

- If you have a mount that requires at least two objects to perform an alignment (see [SETUP MOUNT](#))
- and you want to use a FIX ALT REF angle other than 0° or 90°, or
- or you want to use AUTO ADJUST ON

- then SETUP ALT REF will allow you to specify your own angle.

A good example of the utility of SETUP ALT REF is in using it with some Dobsonian telescopes. Most ‘Dobs’ will not allow you to move the tube in altitude much past the scope’s zenith (90° point). Some fall a little short of the zenith. Others allow you to go a little beyond it. But many have a mechanical stop, such as the “back-board” that prevents you from positioning the scope at a higher altitude. This “stop position” can be exploited to provide a convenient FIX ALT REF “reference point”.

By experimentation or direct measurement, you should be able to determine what angle the scope is at in altitude when it is parked at this stop position. You can then program this angle to be your FIX ALT REF “reference point”. You would then start your observing session by parking the scope at that position and performing a FIX ALT REF step at that point.

Similarly most “Dobs” also have a “stop position” when the tube is brought as low as possible towards the ground. Alternatively, that angle could be determined and exploited as a FIX ALT REF reference point.

As a final example, some Azimuth encoder installations on Fork mounted scopes prevent the tube folding all the way through the Fork. By resting the tube gently on the Azimuth encoder, that position can create a convenient reference point for this style of scope.

Establishing the altitude “reference point” as precisely as possible can dramatically improve your pointing accuracy.

### Using SETUP ALT REF

Enter the MODE SETUP menu then spin the **DIAL** until you see -

**SETUP ALT REF**

Press **ENTER** and the display might show something like this -





ALT REF=+000.000

where the first '+' sign will be flashing. By spinning the **DIAL** the sign can be toggled between a '+' and a '-'. Angles can range from -180° to +180°. When you have selected the correct sign, hit **ENTER**, which advances the flashing 'cursor' to the first numeric field. You can change the value in that field by turning the **DIAL**. When you have selected the correct value, advance the cursor to the right by hitting the **ENTER** button again and so on. When you have finished editing the last field, pressing the **ENTER** button again will exit you from SETUP ALT REF. Alternatively you can press **EXIT** at any time. If the angle you have entered differs from what it originally was ARGO NAVIS™ will briefly display the words -

SAVING ...

while it saves your settings into its memory (EEROM device) and then display the message –

SETUP ALT REF

Assuming you have selected a mount that requires more than one object to align it (see [SETUP MOUNT](#)), you can then press **EXIT** and spin the **DIAL** until you see –

MODE FIX ALT REF

then press **ENTER**. You would then spin the **DIAL** until you see the user-defined angle that you just entered.

### Example

*You have determined that when you move your Dobsonian as far towards the zenith as it will go (it reaches a fixed stop position), the altitude angle corresponds to one of +89.25°.*

If you had entered that angle in SETUP ALT REF, then entered MODE FIX ALT REF you would see -

ALT REF=+089.250  
AUTO ADJUST OFF

Spinning the **DIAL** again you would see –

ALT REF=+089.250  
AUTO ADJUST ON

Having decided whether you want AUTO ADJUST OFF or AUTO ADJUST ON, you would then move your scope to the fixed stop position and press **ENTER** to perform your FIX ALT REF step. AUTO ADJUST ON can be used with Alt/Az (e.g. Dobsonian) and roughly aligned Fork Mounts and can help compensate for a slightly inaccurate reference point setting.

### See also

[MODE FIX ALT REF](#)

[MODE SETUP](#)

## SETUP ALT STEPS

### Function

SETUP ALT STEPS allows you to set the direction sense and number of steps (resolution) of your altitude encoder.

while it saves your settings into its memory (EEROM device) and then display the message –

**SETUP ALT STEPS**

### Using SETUP ALT STEPS

Enter the MODE SETUP menu then spin the **DIAL** until you see -

**SETUP ALT STEPS**

You will then have set your altitude encoder step setting and sense. Note that changing the number of steps will invalidate any prior star alignment you may have performed, including any FIX ALT REF, ALIGN OR ALIGN STAR operation.

Press **ENTER** again and the display might show something like this -

**ALT=+0010000**

The number of steps that can be entered ranges from 1 to 9999999.

+10000 steps is the factory default setting. However, some mounts may be fitted with encoders that provide a different number of steps per revolution, such as 8192 or 5000.

where the '+' sign will be flashing. By spinning the DIAL the sign can be toggled between a '+' and a '-'. This sign denotes the direction sense of the altitude encoder and it is very important that it be set correctly. Follow the instructions on [Determining encoder direction senses](#) in the section [Initial Setup of the ARGO NAVIS™](#) to determine what the correct setting should be for your scope.

German Equatorial Mount (GEM) owners may need to change the direction sense sign if they wish to initially align on a star with the scope on the other side of the mount to which they usually perform their initial alignment. In this case, edit the sign as appropriate and press either **ENTER** or **EXIT**. The direction sense will then be changed and the alignment can then be performed starting with the scope on the opposite side of the mount. Changing the sense of the encoder will not invalidate any prior alignment.

Once you have set the correct sense, press **ENTER** and edit the fields as need be by using the **DIAL** to change a value and **ENTER** to advance to the next field. When the correct number of steps is displayed, press either **ENTER** or **EXIT** and if the value has changed from what it originally was, ARGO NAVIS™ will briefly display the words -

**SAVING ...**

### See also

[MODE SETUP](#)

[SETUP AZ STEPS](#)



ARGO NAVIS™

## SETUP ARCHIVE

### Function

SETUP ARCHIVE allows you to –

- Apply a label name to the current setups by which to remember them by. The current setups are those which are held in [EEROM](#)
- Store that labelled setup into the [FLASH](#) memory archive. You can archive up to four setups with different label names
- Load a setup by selecting it by label name from the FLASH memory archive. The system will load it into EEROM and it will become the current setup

Therefore SETUP ARCHIVE is an ideal way of sharing your ARGO NAVIS™ between multiple telescopes and being able to conveniently switch between them by loading the appropriate setups.

Another potential use of SETUP ARCHIVE is if you want to experiment with different [Telescope Pointing Analysis System™ \(TPAS™\)](#) models.

### Technical background

ARGO NAVIS™ has two types of non-volatile memory storage, [EEROM](#) and [FLASH](#). These memories retain their contents even when all sources of power are removed. The current setups are always stored in EEROM. However, you can save the contents of the EEROM into

a FLASH archive or you can load from the FLASH archive back into EEROM.

### Using SETUP ARCHIVE

Enter the MODE SETUP menu then spin the **DIAL** until you see -

SETUP ARCHIVE

Press **ENTER** and the display might show something like this -

LABEL CURRENT  
SETUP=NO LABEL

where the top-line of the text will be flashing. By spinning the **DIAL** a detent 'click' at a time, the top line of the display can be cycled as follows –

- LABEL CURRENT
- LOAD SETUP
- STORE SETUP

When you have selected the desired sub-menu, press **ENTER**.

For example, in the case of the LABEL CURRENT selection, you might see –

LABEL CURRENT  
SETUP=NO LABEL

where the 'NO LABEL' will be flashing. If you wish to change the name of the label to act as a mnemonic, use the **DIAL** and the **ENTER** button to edit the name one



character at a time. For example, let us edit the name of 'NO LABEL', which is the factory default, to 'OBS 25'.

To do so, press the **ENTER** button. You have now entered label name edit mode.

The '**N**' character will be flashing indicating that the cursor is at that location. Turn the **DIAL** clockwise until the letter '**O**' appears and then press **ENTER** to advance to the next letter, which is an '**O**'. Turn the **DIAL** in either direction to make it a '**B**', press **ENTER**, and so on until you have spelt out the word '**OBS 25**'.

Continue to erase the rest of the characters in the old NO LABEL name by turning them into SPACES. The SPACE character is found just after the letter '**Z**' if you are turning the **DIAL** clockwise. When you have entered two successive SPACE characters, ARGO NAVIS™ automatically leaves object name edit mode and the top-line of the text will be flashing again.

By performing the above, you have now assigned the label of 'OBS 25' to the current setups, which are those held in EEROM.

Now let us say you wish to create new setups for a different telescope mount. First you will need to save your current setups held in EEROM, which in the example above we assigned the label name of 'OBS 25', into the FLASH memory archive.

To do so, spin the **DIAL** until the top line of the display shows –

**STORE SETUP**

Then press **ENTER**. The display will then show –

**STORE OBS 25**  
**NEW=OBS 25**

This denotes that you are about to store the current setups with a label name of 'OBS 25' into an empty archive memory slot which will also be given a name of 'OBS 25'.

To do so, press the **ENTER** button. In the bottom line of the display, you may briefly see the words 'SAVED TO ARCHIVE' followed by –

**STORE SETUP**  
**ARCHIVE THE SAME**

where the top-line of the display will be flashing. The text of 'ARCHIVE THE SAME', denotes that the FLASH memory archive now has an entry that is identical to your current setups held in EEROM. In the future, whenever you see these words, ARGO NAVIS™ is telling you that you do not need to re-save your current setups as you already have a FLASH memory archive set with the same label name and that has identical parameters.

Continuing with the example, since we have saved the OBS 25 setups into the archive, we are now free to alter the current setups held in EEROM and give them a new label.

Let us change the label name first. Spin the **DIAL** until the display shows –

**LABEL CURRENT**  
**SETUP=OBS 25**



Then press **ENTER**. Use the **DIAL** and the **ENTER** button to edit the name one character at a time. For example, let us edit the name to 'GEM'.

Having edited the label name, you would then typically want to **EXIT** out of [SETUP ARCHIVE](#) and edit the various setup parameters to suit your other telescope mount. For example, you might use the [SETUP MOUNT](#) menu and make a selection of GEM EXACT ALIGN. Additional parameters, such as [SETUP ALT STEPS](#) and [SETUP AZ STEPS](#) may often require changing as well.

Once you have edited the parameters for this other telescope mount, it would then be wise to save a copy of them into the FLASH memory archive. Go back to [SETUP ARCHIVE](#) and press **ENTER** and spin the **DIAL** until you see –

STORE SETUP

Then press **ENTER**. The display will then show –

STORE SETUP  
NEW=GEM

This denotes that you are about to store the current setups with a label name of 'GEM' into an empty archive memory slot which will also be given a name of 'GEM'.

To do so, press the **ENTER** button. In the bottom line of the display, you may briefly see the words 'SAVED TO ARCHIVE' followed by –

STORE SETUP  
ARCHIVE THE SAME

You now have setups for two different telescope mounts saved in the FLASH memory archive. The current set, which is the one also stored in EEROM, is labelled 'GEM'. There is another set in the FLASH memory archive which you previously labelled 'OBS 25'.

To load the set labelled 'OBS 25' back into EEROM so that it becomes the current set, spin the **DIAL** until you see -

LOAD SETUP  
2 MEMBERS

The bottom-line of the display denotes that you have two setups stored in the FLASH memory archive. Press **ENTER** and the display might show something like this -

LOAD SETUP  
FROM=GEM

where the word 'GEM' will be flashing. Spin the **DIAL** a detent 'click' at a time until the display shows –

LOAD SETUP  
FROM=OBS 25

Then press **ENTER**. The display will then briefly show –

ARGO NAVIS  
RESTARTING

Then briefly followed by –

ARGO NAVIS  
SETUP=OBS 25



Then briefly followed by –

ARGO NAVIS  
INITIALIZING

ARGO NAVIS™ has loaded the setups for the 'OBS 25' mount and re-initialized. Any existing alignment will now be invalidated.

Whenever the unit is subsequently powered ON, if there is more than one setup stored in the FLASH memory archive, ARGO NAVIS™ will briefly show the label name of the setup currently in use.

You can also determine which setup is currently in use via [MODE STATUS](#). To access it, spin the **DIAL** in the top-level 'MODE' menu until the display shows –

MODE STATUS

Then press **ENTER**. Then spin the **DIAL** until the display shows, for example–

STATUS SETUP  
LABEL=OBS 25

where the text following the 'LABEL=' is the label name assigned to the current setups in EEROM.

Whenever you modify the current setups, you are only altering the values held in EEROM. If you then wish to go back to using the parameters stored in the archive, re-enter the **SETUP ARCHIVE** menu and use the **LOAD SETUP** submenu and load the appropriate set.

Alternatively, if you wish to update the setup in the FLASH memory archive, use the **STORE SETUP** submenu. Initially the display might show –

STORE SETUP  
ARCHIVE DIFFERS

The text of 'ARCHIVE DIFFERS' denotes that the FLASH memory archive has a member with the same label name but whose content is different to your current setups held in EEROM.

To update the archive member, press **ENTER**. The display might then show –

STORE OBS 25  
TO=OBS 25

If you press **EXIT**, ARGO NAVIS™ will abort the operation. Alternatively if you press **ENTER**, ARGO NAVIS™ will then save the current setups held in EEROM into the FLASH archive. In the bottom line of the display, you may briefly see the words 'SAVED TO ARCHIVE' followed by –

STORE SETUP  
ARCHIVE THE SAME

### Number of members allowed in the archive

The FLASH memory archive allows you to save up to four sets of setups. You can determine how many members there are in the archive by examining the bottom-line in the 'LOAD SETUP' sub-menu.





### **Purging a member by storing over it when the archive becomes full**

When the FLASH memory archive has four members, it is full. However, when it becomes full, ARGO NAVIS™ allows you to purge an existing member when you attempt to store a setup with a new label name.

For example, if the archive were full, spin the **DIAL** until the top line of the display shows –

**STORE SETUP**

Then press **ENTER**. The display will then briefly show –

**STORE G11  
ARCHIVE FULL**

where in this example ‘G11’ might be a label name you have assigned to the current setups. Shortly after, the display will then show –

**STORE G11  
PURGE=GEM**

where in this example ‘GEM’ might a label for an existing archive member and whose text will be flashing. If need be, spin the **DIAL** until you select a member that you wish to usurp. Then press **ENTER**. In the bottom line of the display, you may briefly see the words ‘SAVED TO ARCHIVE’ followed by –

**STORE SETUP  
ARCHIVE THE SAME**

### **Permanently deleting a member from SETUP ARCHIVE**

To permanently delete a member from the FLASH memory archive, use the ‘LABEL CURRENT’ submenu and change the label to the special reserved word of DELETE. Then use the ‘STORE SETUP’ submenu and store it to the member that you wish to permanently delete. That member will now be purged, the member count will decrease by one and a free memory slot will be made available in the FLASH memory archive.

Since the current label name was changed to ‘DELETE’, you will typically want to restore your original name by either loading the appropriate member from the ‘LOAD SETUP’ submenu or by editing the name in the ‘LABEL CURRENT’ submenu.



**ARGO NAVIS™**

## SETUP ATLAS

### Function

SETUP ATLAS allows you to specify the reported star atlas reference. This reference is reported in descriptions of objects and can also be reported in MODE AZ ALT and MODE RA DEC. The current star atlas choices are –

- Herald-Bobroff ASTROATLAS™ published by HB2000 Publications
- Millennium Star Atlas™ published by Sky Publishing.
- Star Atlas 2000™ by Wil Tirion.
- Uranometria 2000™ Edition 1 by Tirion, Rappaport & Lovi, published by Willmann-Bell, Inc.
- Uranometria 2000™ Edition 2 by Tirion, Rappaport & Lovi, published by Willmann-Bell, Inc.

### Using SETUP ATLAS

Enter the MODE SETUP menu then spin the **DIAL** until you see -

**SETUP ATLAS**

then press **ENTER**. The display will indicate the current star atlas reference. For example-

**HERALD-BOBROFF**

indicates that the Herald-Bobroff ASTROATLAS™ is the current reported reference. This is the factory default. Spinning the **DIAL** a detent 'click' at a time toggles the atlas to be either HERALD-BOBROFF, MILLENNIUM ATLAS, STAR ATLAS 2000, URANOMETRIA 2K 1

(First Edition) or URANOMETRIA 2K 2 (Second Edition).

When you have set the desired atlas reference, press **EXIT** or **ENTER**. If you have changed the atlas from what it originally was, ARGO NAVIS™ will save the new setting into its memory (EEROM device).

When reported, Herald-Bobroff ASTROATLAS is abbreviated HB, Millennium Star Atlas™ is abbreviated MSA, Star Atlas 2000™ as SA, Uranometria 2000™ Edition 1 as UM and Uranometria 2000™ Edition 2 as UM2.

For the Herald-Bobroff ASTROATLAS, ARGO NAVIS™ will report a reference to the highest resolution chart (one of F, E or D charts) and the lowest resolution chart (C chart) that the object or co-ordinate position appears on.

### Example

Assume your scope is pointing at the co-ordinates 12:26.8 RA and 63°07' Dec. In the top level menu, spin the **DIAL** until you find –

**MODE RA DEC**

Then press **ENTER** and then press **ENTER** again. The display would briefly show -

**12:26.8 -63°07'**  
**MSA=VOL II 1002**

The star atlas reference is reported on the bottom line. In this case, Millennium Star Atlas™ Volume II page 1002.



ARGO NAVIS™

**See also**

[MODE AZ ALT](#)

[MODE CATALOG](#)

[MODE IDENTIFY](#)

[MODE SETUP](#)

[MODE RA DEC](#)

[MODE TOUR](#)



ARGO NAVIS™

## SETUP AZ STEPS

### Function

SETUP AZ STEPS allows you to set the direction sense and number of steps (resolution) of your azimuth encoder.

### Using SETUP AZ STEPS

Enter the MODE SETUP menu then spin the **DIAL** until you see -

**SETUP AZ STEPS**

Press **ENTER** again and the display might show something like this -

**AZ=+0010000**

where the '+' sign will be flashing. By spinning the DIAL the sign can be toggled between a '+' and a '-'. This sign denotes the direction sense of the azimuth encoder and it is very important that it be set correctly. Follow the instructions on [Determining encoder direction senses](#) in the section [Initial Setup of the Argo Navis™](#) to determine what the correct setting should be for your scope.

Once you have set the correct sense, press **ENTER** and edit the fields as need be by using the **DIAL** to change a value and **ENTER** to advance to the next field. When the correct number of steps is displayed, press either **ENTER** or **EXIT** and if the value has changed from what it originally was, ARGO NAVIS™ will briefly display the words -

**SAVING ...**

while it saves your settings into its memory (EEROM device) and then display the message -

**SETUP AZ STEPS**

You will then have set your azimuth encoder step setting and sense. Note that changing the number of steps will invalidate any prior star alignment you may have performed, including any FIX ALT REF, ALIGN or ALIGN STAR operation.

The number of steps that can be entered ranges from 1 to 9999999.

+10000 steps is the factory default setting. However, some mounts may be fitted with encoders that provide a different number of steps per revolution, such as 8192, 5000 or 32000.

If you would like to know the angle in arcminutes that one encoder step subtends, divide 21,600 by the number of encoder steps. Thus, a 10,000 step encoder provides a resolution of approx. 2.16' per step.

### See also

[MODE ENCODER](#)

[MODE SETUP](#)

[SETUP ALT STEPS](#)



## SETUP BRIGHTNESS

### Function

SETUP BRIGHTNESS allows you to adjust the brightness (intensity) of the Liquid Crystal Display.

Dimming the display has two advantages –

1. It helps you preserve your night vision, which assists in being able to observe faint objects.
2. It results in a considerable power saving. If you are powering your unit from internal AA cell batteries, this can help dramatically increase their life.

### Using SETUP BRIGHTNESS

Enter the MODE SETUP menu then spin the **DIAL** until you see -

**SETUP BRIGHTNESS**

then press **ENTER**.. Spin the **DIAL** clockwise to brighten the display or anti-clockwise to dim it. The brightness settings range from 1% (dim) to 100% (bright). The factory default setting is 50%.

For example –

**BRIGHTNESS= 3%**

indicates that the brightness is at 3% which would result in a dim display and would also produce a considerable power saving.

When you have adjusted the brightness to suit your requirements,

press **EXIT** or **ENTER**. If you have changed the value from what it originally was, the word **SAVING ...** will appear briefly on the bottom line as **ARGO NAVIS™** stores the new setting into its memory (EEROM device).

### See also

[MODE SETUP](#)

[SETUP CONTRAST](#)

[SETUP SCROLL](#)



## SETUP CONTRAST

### Function

Normally the factory default contrast setting for the Liquid Crystal Display (LCD) is pre-set for optimal viewing. However, SETUP CONTRAST allows you to adjust it if necessary.

### See also

[MODE SETUP](#)

[SETUP BRIGHTNESS](#)

[SETUP SCROLL](#)

### Using SETUP CONTRAST

Enter the MODE SETUP menu then spin the **DIAL** until you see -

**SETUP CONTRAST**

then press **ENTER**. Position your head so as to view the display from the angle you normally use it. Try spinning the **DIAL** in both directions until you achieve optimum contrast. You should ensure that both lines of the display remain readable. The contrast settings range from 1% to 100%. The factory default setting is 67%.

For example –

**CONTRAST= 67%**  
**MUST BE VISIBLE**

indicates that the contrast is at 67%. Note that the text on the bottom should be readable.

When you have adjusted the contrast to suit your requirements, press **EXIT** or **ENTER**. If you have changed the value from what it originally was, the word **SAVING ...** will appear briefly on the bottom line as ARGO NAVIS™ stores the new setting into its memory (EEROM device).



ARGO NAVIS™



## SETUP DATE/TIME

### Function

SETUP DATE/TIME allows you to set your time zone and the current local date and time.

ARGO NAVIS™ contains an in-built battery-backed time of day clock. An internal lithium coin cell battery powers the clock even when the power is switched off or the main batteries are removed.

Though ARGO NAVIS™ does not require you to set the time or your location to operate, doing so provides the following additional features and benefits:

- The local time and date, the UTC (Greenwich) time and date and the current Julian date will be available to you from the [MODE TIME](#) menu.
- The Local Apparent Sidereal Time (LAST) will be available to you in [MODE SIDEREAL](#) if you have also specified your location in [SETUP LOCATION](#).
- The topocentric azimuth and altitude will be available to you in [MODE AZ ALT](#) assuming you have also specified your location and have performed a valid star alignment.
- The HORIZON MASK filtering option will be applied correctly in [MODE IDENTIFY](#) and [MODE TOUR](#) assuming that you have [also specified your location](#).
- If in [SETUP GUIDE MODE](#) the GUIDE BELOW HORZ setting has been set

TO H INDICATOR ON, then an 'H' symbol will appear on the GUIDE mode display whenever an object is computed to be below the computed horizon, which in turn also assumes that you have [specified your location](#).

- Correction for atmospheric refraction will be made while you point your scope assuming you have also specified your location and assuming you have turned refraction correction ON in the [SETUP REFRACTION](#) sub-menu.
- Objects will be precessed and nutated from their internally stored J2000.0 epoch positions to their actual position at the time you observe them.
- The positions of planets can be accurately determined.
- The positions of asteroids and comets can be computed from their orbital elements.
- The position of earth orbiting satellites can be computed assuming you have also specified your location.
- If you have a [ServoCAT™ GOTO and track system](#), ARGO NAVIS™ will provide horizon limit checking when running the "[servocat](#)" [STARTUP](#) command on the ARGO NAVIS™ serial port. Horizon limit checking also assumes you have specified your location.



# ARGO NAVIS™

For these reasons it is worthwhile setting your local time zone, date and time. Since ARGO NAVIS™ retains the time even when it is powered off, you only need do it once and then possibly occasionally to correct for normal clock drift.

### Using SETUP DATE/TIME

Enter the MODE SETUP menu then spin the **DIAL** until you see -

SETUP DATE/TIME

then press **ENTER**. ARGO NAVIS™ will display something like -

TIMEZONE=+00:00

Where the '+' (or possibly '-') sign will be flashing.

To understand the concept of time zone, it is important to know that ARGO NAVIS™ always internally keeps track of time in terms of Universal Co-ordinated Time (UTC), which was previously referred to as Greenwich Mean Time (GMT). The time zone is the number of hours that your local time differs from UTC. For example, in New York when Daylight Savings Time (Summer time) is not in effect, the time zone setting is -05:00 hours. When Daylight Savings (Summer Time) is in effect, the time zone is -4:00. In Sydney, when Daylight Savings time is not in effect, the time zone setting is +10:00 hours and when Daylight Savings is in effect +11:00. In New Delhi the time zone is +05:30.

Use the section [World time zones](#) to determine your local time zone. If you are

in a time zone that is west of Greenwich, you will set the sign to a '-'. If you are in a time zone that is east of Greenwich, you will set the sign to a '+'.

By turning the **DIAL** you can change the sign alternately between a '+' and a '-'. When you have selected the correct sign, hit **ENTER**, which advances the flashing 'cursor' to the first numeric field. You can change the value in that field by turning the **DIAL**. When you have selected the correct value, advance the cursor to the right by hitting the **ENTER** button again and so on. When you have finished editing the last field (most people will live in a time zone that is only a whole number of hours offset from UTC), pressing the **ENTER** button again will result in a display something like

DATE=23 APR 2017  
TIME=15:30:45

where the first digit will be flashing. Again, as in editing the time zone, edit the correct local date and time by using the **DIAL** and pressing the **ENTER** button to advance over fields. If you make a mistake, press **EXIT** and start-over again. Keep in mind that you are entering your local date and time here, not the UTC time. ARGO NAVIS™ will perform the appropriate arithmetic to convert the date and time you enter to internal UTC time by taking into account the time zone you entered.

When you have edited the last field, you may like to synchronize the pressing of the **ENTER** button against some correct time reference. ARGO NAVIS™ will then briefly display the words



ARGO NAVIS™

### SAVING ...

And then the words

### INITIALIZING ...

In the lower half of the display before returning to the SETUP sub-menu with the message

### SETUP DATE/TIME

You have now successfully set your local time zone and your local date and time.

While the **SAVING...** message appeared, ARGO NAVIS™ saved your time zone setting into its memory (EEROM device) and the date and time into the battery backed time-of-day clock. While the **INITIALIZING ...** message appeared, ARGO NAVIS™ re-initialized such things as the positions of planets, asteroids and comets and recalculated the amount of precession and nutation to account for since the J2000.0 epoch.

It is handy to remember that whenever Daylight Savings comes into or out of force in your locality, simply edit the time zone by adding or subtracting an hour from it as necessary. There is no need to change the local time as changing the time zone will automatically perform the correct arithmetic.

Normally the lithium coin cell battery used by the time of day clock should last for several years. If for any reason it should run flat, when ARGO NAVIS™ is powered on, it will display briefly this message

### RTC BATTERY FLAT



ARGO NAVIS™

Followed by this message

SETTING DATE TO  
12:00 1 JAN 2000

See the section [How to replace the lithium coin cell battery](#) for details.

Note that changing the date or time will invalidate any prior star alignment you may have performed, including any FIX ALT REF, ALIGN or ALIGN STAR operation. Changing the time zone alone will not.

### See also

[MODE SIDEREAL](#)

[MODE SETUP](#)

[MODE TIME](#)

[SETUP LOCATION](#)

[SETUP REFRACTION](#)

## SETUP DEBUG

### Function

SETUP DEBUG allows you to toggle the DEBUG state to either ON or OFF. When it is in the ON state, ARGO NAVIS™ sends additional debug information to the **SERIAL1** communications port when certain operations or events occur. If you are using **SERIAL1** for any other purpose, then this additional data may interfere with that communications flow. Furthermore, the transmission of this additional data can sometimes slightly slow the responsiveness of your unit.

Wildcard Innovations uses debug mode for customer support operations.

### Using SETUP DEBUG

Enter the MODE SETUP menu then spin the **DIAL** until you see -

**SETUP DEBUG**

then press **ENTER**. Spin the **DIAL** a detent 'click' at a time to toggle the DEBUG state to be either ON or OFF.

For example -

**DEBUG=OFF**

indicates that the DEBUG mode is OFF. This is the factory default state.

When changing the debug mode from OFF to ON, you will see -

**DEBUG=ON**  
**KEY=**

In this circumstance, ARGO NAVIS™ prompts you to enter a 'KEY' passphrase. This passphrase would only be issued to you should Wildcard Innovations request you supply additional debug information. We would then advise that you keep debug mode OFF unless Wildcard requests you to switch it ON as part of a support call.

When you have set the desired state, press **ENTER**. If you have successfully changed the state from what it originally was, the word **SAVING ...** will appear briefly on the bottom line as ARGO NAVIS™ stores the new setting into its memory (EEROM device).

### See also

[MODE SETUP](#)



## SETUP DEFAULTS

### Function

SETUP DEFAULTS allows you to restore your unit to its factory default settings. This will erase all your settings that you have stored in the SETUP menus. Therefore, it is advisable to keep a copy on paper of any of your settings that you might later wish to restore. In particular, you should probably take note of your SETUP ALT STEPS, SETUP AZ STEPS, SETUP LOCATION, SETUP MOUNT and SETUP MNT ERRORS settings.

### Using SETUP DEFAULTS

Enter the MODE SETUP menu then spin the **DIAL** until you see -

**SETUP DEFAULTS**

then press **ENTER**. The display will show -

**FACTORY=NO**

Spin the **DIAL** a detent 'click' at a time to toggle the FACTORY state to be either YES or NO. For example -

**FACTORY=YES**

indicates that factory defaults will be restored when you leave SETUP DEFAULTS.

When you have set the desired state, press **EXIT** or **ENTER**. If you have changed the state to **YES**, ARGO NAVIS™ will restore the factory defaults to its

memory (EEROM device). Your old settings will be erased.

There is an additional way of setting your unit to its factory default setting. Power your unit off. Keep depressed both the **EXIT** and **ENTER** buttons then power the unit on. The message -

**FACTORY DEFAULTS  
RESTORED**

should appear, followed by -

**ARGO NAVIS  
INITIALISING**

You should then release the buttons. If this message appears -

**FACTORY DEFAULTS  
NOT RESTORED**

there might be a problem with your unit. In this case, contact Wildcard Innovations.

### See also

[MODE SETUP](#)



## SETUP ENC TIMING

### Function

SETUP ENC TIMING allows the timing parameters of the encoders to be altered.

**Changing the encoder timing from the factory default values to some other value may result in your ARGO NAVIS™ being unable to correctly read the encoders. If in doubt, contact Wildcard Innovations for advice.**

### Using SETUP ENC TIMING

Enter the MODE SETUP menu then spin the **DIAL** until you see -

SETUP ENC TIMING

then press **ENTER**. The display will show something like this -

SETUP ENC TIMING  
TON= 17 TOFF= 17

where the '17' will be flashing. This is the encoder "Time-On" parameter and its factory default value is '17'. It may be changed dynamically by spinning the **DIAL**.

Once you have selected the value for the "Time-On" parameter, press **ENTER**. The "Time-Off" parameter can then be edited dynamically by spinning the dial. Its factory default value is '17'. The value of '0' is special and will leave the encoders permanently switched on. This value results in the encoders drawing the maximum power from your unit. If you are powering your unit from internal AA cells

only, this will have a dramatic effect upon the life of the batteries.

Once you have selected the value for the "Time-Off" parameter, press **ENTER**. The word **SAVING ...** will appear briefly on the bottom line as ARGO NAVIS™ stores the new setting into its memory (EEROM device).

If there is a requirement to stop the encoders on a once-only basis, the following procedure can be used. Power off ARGO NAVIS™ and press and keep depressed the **ENTER** button. Now power the unit on. The display will show -

ARGO NAVIS  
INITIALIZING

followed briefly by -

ENCODERS STOPPED

Release the **ENTER** button and then press **EXIT** and you will be in the top-level menu. The encoders will be halted.

### Encoder Timing

The following table itemizes some typical TON/TOFF settings showing the resulting ON/OFF times in microseconds as well as the effective sampling rate. Also shown is the power consumption as a percentage of the case where the encoders are permanently ON.





TON	TOFF	ON Time	OFF Time	Sampling Rate	Power Consumption As Percentage of Encoders Always ON	Notes
Any Value	0	Always ON	Never OFF	~16kHz	100%	Encoders always ON. Highest sampling rate. Highest power consumption. Use this with 32,000 step encoders.
2	10	28 $\mu$ s	59 $\mu$ s	11.5kHz	65%	Works with most native 10,000 step encoders to provide a very high sampling rate. May not work with some encoders.
4	10	32 $\mu$ s	59 $\mu$ s	11.0 KHz	69%	Works with most native 10,000 step encoders to provide a very high sampling rate. May not work with some encoders.
17	17	54 $\mu$ s	61 $\mu$ s	8.7kHz	80%	Factory default setting. Will work reliably with nearly all encoder types and will provide a high sampling rate.
19	19	58 $\mu$ s	66 $\mu$ s	8.1kHz	80%	Will work reliably with nearly all encoder types and will provide a high sampling rate.
17	170	54 $\mu$ s	333 $\mu$ s	2.6KHz	51%	Will work with nearly all encoder types to provide low power consumption at the trade-off of a lower sampling rate.



ARGO NAVIS™

Incorrect setting of the TON/TOFF parameters will result in the encoders not being read correctly.

Due to their electrical timing characteristics, encoders with a native resolution of 8192 or 10,000 steps typically require a TON setting of 2 or greater. These encoders are typically packaged in cases that have a diameter of 55.9mm (2.2”).

Encoders with lower resolutions often require a TON setting of 17 or greater. These encoders are typically packed in cases that have a diameter of 30mm (1.18”).

Encoders with very high resolutions such as 32,000 require TON to have any non-zero value and TOFF=0.

**Except for the special case where TOFF equals 0, TOFF must always be set to be equal to or greater than TON.**

The values of TON and TOFF influence the effective sampling rate of the encoders and how much power they consume. See [MODE ENCODER](#) for a further discussion of encoder sampling.

A higher sampling rate means that the telescope can be slewed more quickly without encoder steps being “missed”. When encoder steps are missed, an encoder error message is displayed.

However, the TON and TOFF values also influence the overall power consumed by the encoders. This can impact upon battery life.

If the unit is always powered by an external DC power source, such as a car battery, where power consumption is not an issue, then it might be worth considering setting TON to any value and TOFF to 0. Since the encoders are then

never switched off, this will result in the highest possible sampling rate. This mode of operation can also be useful to help track down an encoder or encoder-cabling fault. If slewing the telescope still results in encoder error messages when the unit has been set in such a way, chances are that the encoder cable or one or more encoders themselves have developed a fault.

If using internal AA cells and both encoders have a native resolution of 8192 or 10,000 steps, it might be worth trying a TON value of 2 and a TOFF value of 10. This will produce a high sampling rate with only modest power consumption. If this setting results in frequent encoder error messages, next try a setting of TON=4 TOFF=10.

#### See also

[MODE ENCODER](#)

[MODE SETUP](#)

[SETUP DEFAULTS](#)

[SETUP LCD HEATER](#)



ARGO NAVIS™

## SETUP EQ TABLE

### Function

The SETUP EQ TABLE menu will only appear if you have set a mount type of EQ TABLE EXACT in [SETUP MOUNT](#).

SETUP EQ TABLE provides sub-menus that allow you to examine or set the following -

- the EQ TABLE ALARM time which is the amount of sidereal time (see [Glossary](#)) that will appear in the EQ TBL REMAINING time display of [MODE EQ TABLE](#) when the equatorial table timer is stopped.
- EQ TABLE SOUND which determines if an audible alarm will be emitted when the EQ TBL REMAINING time display reaches 00:00:00.0 in [MODE EQ TABLE](#).

### Using SETUP EQ TABLE

Assuming you have set a mount type of EQ TABLE EXACT in [SETUP MOUNT](#), enter the MODE SETUP menu then spin the **DIAL** until you see -

**SETUP EQ TABLE**

then press **ENTER**. Then spin the **DIAL** to choose one of the following sub-menus -

**EQ TABLE ALARM**

**EQ TABLE SOUND**

Press **ENTER** again to enter the chosen sub-menu.

**EQ TABLE ALARM** can be used to set the amount of sidereal time that will appear in the EQ TBL REMAINING time display of [MODE EQ TABLE](#) when the equatorial table timer is stopped. For example, if you enter EQ TABLE ALARM the display might show -

**EQ TABLE ALARM**  
**TIME=12:00:00**

where the first digit to the right of the “=” sign will be flashing. The example indicates an alarm time of 12 sidereal hours. By turning the **DIAL** you can change the numeric value that appears in the field that is flashing. When you have selected the desired value, hit **ENTER**, which advances the flashing ‘cursor’ to the next numeric field. By using the **DIAL** to change values and **ENTER** to advance to successive fields, you can set the alarm time as desired. Either when **ENTER** is pressed after editing the right-most field or when **EXIT** is pressed at any time, the alarm time will be set. If you have changed the alarm time from what it originally was, the word **SAVING ...** will appear briefly on the bottom line as ARGO NAVIS™ stores the new setting into its memory (EEROM device). The word **INITIALIZING ....** will then appear and ARGO NAVIS™ will invalidate any alignment you have made and stop the equatorial table timer if it was running.

**EQ TABLE SOUND** is used to set whether an audible alarm will be sounded when the EQ TBL REMAINING time display



reaches 00:00:00.0 in [MODE EQ TABLE](#)..  
For example, if you enter EQ TABLE SOUND  
the display might show -

EQ TABLE SOUND  
ALARM=OFF

where the field to the right of the '=' sign  
will be flashing. By using the **DIAL** you  
can alternate the setting to be either '**OFF**'  
or '**ON**'.

After making your selection, press  
either **ENTER** or **EXIT**. If you have  
changed the setting from what it originally  
was, the word **SAVING ...** will appear  
briefly on the bottom line as ARGO  
NAVIS™ stores the new setting into its  
memory (EEROM device).

**See also**

[MODE EQ TABLE](#)

[MODE SETUP](#)



ARGO NAVIS™

## SETUP GOTO

### Function

SETUP GOTO is used to set or examine parameters that provide Altitude motion limit checking and audible alarms when ARGO NAVIS™ is interfaced to specific motorised GOTO controllers.

The following table summarizes which features of SETUP GOTO are supported for various GOTO controllers when the ARGO NAVIS™ [serial communications port](#) to which the controller is attached is running the startup command cited.

Controller & serial port startup command	GOTO ALT LIMIT check support	AUDIBLE ALARM support
<a href="#">ServoCAT™ controller</a> . Startup command - servocat	yes	yes
SiTech™ controller. Startup command - sitech	yes	no
Skytracker™ controller Startup command – skycomm.	no	no

It is the user's responsibility to ensure that they do not attempt to slew their mount beyond its mechanical limits.

To assist you in this regard, you may wish to set the lower and upper Altitude limit parameters in SETUP GOTO.

In this instance, the 'Altitude' of the scope is defined by the angular value of the Alt Encoder, which can be examined at any time using [MODE ENCODER](#).

When the mount type set in [SETUP MOUNT](#) is of a type that requires a [FIX ALT REF](#) step and a two star alignment, you should be aware that the 'Altitude' of the scope cannot be established until you have performed the [FIX ALT REF](#) step. Thus, the limits set in SETUP GOTO will not be valid until the [FIX ALT REF](#) step is performed. Likewise, for mounts that require only a one star alignment, the Altitude value cannot be established until you perform a valid [MODE ALIGN STAR](#) or [MODE ALIGN](#) step.

When the ARGO NAVIS™ [serial communications port](#) to which the controller is attached is running either the servocat or sitech startup commands, in addition to the above check on the Altitude encoder value, ARGO NAVIS™ also checks for requests from the GOTO controller that would cause the mount to slew beneath the local topocentric horizon.

ARGO NAVIS™ can only determine where the local horizon is if you have set a valid time zone, date, time and location and a valid alignment. Where the telescope is pointing in terms of a topocentric azimuth-altitude co-ordinate



system can be determined by examining [MODE AZ ALT](#).

The [ServoCAT™ controller](#) also has the capability to command the ARGO NAVIS™ to issue an alarm sound when both units are running the servocat startup command protocol. The GOTO LIMIT SOUND sub-menu can be used to either activate or mute alarm requests.

The [ServoCAT™ controller](#) may issue an alarm request for a variety of reasons. For example, it may issue an 'up-beat' 'good alarm' sound request if you use the 'align from ServoCAT™ hand controller feature'. It may issue a 'down-beat', 'bad alarm' sound if you attempt to slew the mount beyond its mechanical limits.

### Using SETUP GOTO

Enter the MODE SETUP menu then spin the **DIAL** until you see -

**SETUP GOTO**

then press **ENTER**. The display might then show -

**GOTO LIMIT SOUND  
ALARM=ON**

where the top-line of the text will be flashing. By spinning the **DIAL** a detent 'click' at a time, the top line of the display can be cycled as follows -

- **GOTO LIMIT SOUND**
- **GOTO LIMITS**

When you have selected the desired attribute that you wish to modify, press **ENTER**.

For example, in the case of the GOTO LIMIT SOUND selection, you might see -

**GOTO LIMIT SOUND  
ALARM=ON**

where the 'ON' will be flashing. The ON state indicates that ARGO NAVIS™ will sound an alarm when commanded to by the GOTO controller.

Spinning the **DIAL** a detent 'click' at a time toggles the value to be either ON or OFF. For example -

**ALARM=OFF**

indicates that the ARGO NAVIS™ will remain silent when the GOTO controller issues an alarm command.

When you have set your alarm sound preference, press **EXIT** or **ENTER**. If you have changed the value from what it originally was, ARGO NAVIS™ will save the new setting into its memory (EEROM device).

To alter the limits of travel in Altitude for the scope, spin the **DIAL** until the top line of the display shows the GOTO LIMITS selection, then press **ENTER**. For example, the display might then show -

**GOTO LIMITS  
LOW=10° HI=+80°**

where the value after **LOW=** will be flashing. This value, which is expressed in degrees, is the lower limit that the scope can be commanded to slew in Altitude from the GOTO controller.





To change the value, spin the **DIAL** until the desired lower limit appears and then press **ENTER**. The value after HIGH= will then be flashing. This value, which is expressed in degrees, is the upper limit that the scope can be commanded to slew in Altitude from the GOTO controller. To change the value, spin the **DIAL** until the desired lower limit appears.

When you have set your GOTO limits preference, press **EXIT** or **ENTER**. If you have changed the value from what it originally was, ARGO NAVIS™ will save the new setting into its memory (EEROM device).

**See also**

- [MODE ALIGN](#)
- [MODE ALIGN STAR](#)
- [MODE AZ ALT](#)
- [MODE ENCODER](#)
- [MODE FIX ALT REF](#)
- [MODE SETUP](#)
- [SETUP DATE/TIME](#)
- [SETUP LOCATION](#)
- [SETUP SERIAL](#)
- [Using ARGO NAVIS™ with the ServoCAT Track/GOTO controller](#)



ARGO NAVIS™

## SETUP GUIDE MODE

### Function

SETUP GUIDE MODE allows you to examine or set certain attributes that influence how information is displayed when the unit is in GUIDE MODE.

GUIDE mode itself is entered via the [MODE CATALOG](#), [MODE IDENTIFY](#) or [MODE TOUR](#) menus.

SETUP GUIDE MODE provides sub-menus that allow you to examine or set the following attributes -

- the GUIDE ALT ARROW direction sense. The possible selections are DEFAULT and REVERSED. When reversed, a GUIDE mode arrow that would normally display as an '↑' will display as a '↓' and vice versa. Do not confuse the GUIDE mode arrow direction sense with the Alt encoder direction sense. See [SETUP ALT STEPS](#). The GUIDE mode arrow direction sense only changes the arrow symbol that is displayed for a given guiding direction and is simply a matter of personal preference whereas the setting of the encoder direction sense in [SETUP ALT STEPS](#) is [dependent on several factors](#) and only has one correct setting for your mount.
- the GUIDE AZ ARROW direction sense. The possible selections are DEFAULT and REVERSED. When reversed, a GUIDE mode arrow that would normally display as an '→' will display as an '←' and vice

versa. As with the GUIDE ALT ARROW setting, do not confuse this with the Az encoder direction sense. See [SETUP AZ STEPS](#).

- the GUIDE BELOW HORZ indicator mode. If the GUIDE BELOW HORZ setting has been set TO H INDICATOR ON, then an 'H' symbol will appear on the GUIDE mode display whenever an object is computed to be below the computed horizon, which in turn also assumes that you have specified your [date, time](#) and [location](#).
- the GUIDE DECIMAL mode. This specifies whether one or two digits are displayed after the decimal point in GUIDE mode operations when the angle is less than 0.1°. Therefore angles can be displayed either to the nearest 1/10<sup>th</sup> or nearest 1/100<sup>th</sup> of a degree. Keep in mind that the actual displayed angle is still limited by your encoder resolution. Setting 2 decimal digits might be appropriate if your encoder resolution is 8192 steps or higher.

### Using SETUP GUIDE MODE

Enter the MODE SETUP menu then spin the **DIAL** until you see -

**SETUP GUIDE MODE**

then press **ENTER**. The display might then show -



**GUIDE ALT ARROW  
DEFAULT**

where the top-line of the text will be flashing. By spinning the **DIAL** a detent 'click' at a time, the top line of the display can be cycled as follows –

- **GUIDE ALT ARROW**
- **GUIDE AZ ARROW**
- **GUIDE BELOW HORZ**
- **GUIDE DECIMAL**

When you have selected the desired attribute that you wish to modify, press **ENTER**. For example, in the case of the **GUIDE DECIMAL** selection, you might see –

**GUIDE DECIMAL  
1 DECIMAL PLACE**

where the '1' will be flashing. This indicates that one digit after the decimal point will be displayed while guiding when the angle is less than 0.1°. This is the factory default.

Spinning the **DIAL** a detent 'click' at a time toggles the value to be either '1' or '2'. For example –

**GUIDE DECIMAL  
2 DECIMAL PLACES**

indicates that two decimal digits will be displayed after the decimal point while guiding when the angle is less than 0.1°.

When you have set the desired number of decimals, press **EXIT** or **ENTER**. If you have changed the value from what it

originally was, **ARGO NAVIS™** will save the new setting into its memory (EEROM device).

**Examples**

Example 1.

*You have set the **GUIDE DECIMAL** to be 1. While in **GUIDE** mode the display might look like this -*

**DUNLOP 203  
GUIDE 0→1 0↓0**

Example 2.

*You have set the **GUIDE DECIMAL** to be 2. While in **GUIDE** mode the display might look like this -*

**DUNLOP 203  
GUIDE 0→08 0↓03**

Example 3.

*Your unit has the **GUIDE AZ ARROW** set to its default direction sense. While in **GUIDE** mode the display might look like this -*

**TARANTULA NEBULA  
GUIDE 25→4 0↓01**

*However, you would prefer if the Az arrow pointed in the opposite direction, as in your particular circumstances, this would then be more intuitive as to which way you needed to rotate the scope. You would therefore set **GUIDE AZ ARROW** to be **REVERSED**. The display would then appear like this –*

**TARANTULA NEBULA  
GUIDE 25←4 0↓01**



Example 4.

*You have set the GUIDE BELOW HORZ setting to be H INDICATOR ON. If Saturn was below your local horizon, then while in GUIDE mode the display might look like this -*

SATURN  
GUIDE 12→ 15↓ H

*Here the 'H' symbol on the bottom-line of the display denotes that the target object is below the local computed horizon.*

**See also**

[MODE CATALOG](#)

[MODE IDENTIFY](#)

[MODE SETUP](#)

[MODE TOUR](#)

[SETUP DATE/TIME](#)

[SETUP LOCATION](#)



ARGO NAVIS™

## SETUP LCD HEATER

### Function

SETUP LCD HEATER allows you to establish the policy by which the Liquid Crystal Display (LCD) is heated.

The response time of all LCD's degrades with lowering temperature resulting in characters appearing to switch off and on more slowly. ARGO NAVIS™ is fitted with an extended temperature LCD. However, at temperatures below 0°C (32°F) you may notice that it changes more slowly.

The LCD can be kept warm in several ways –

- By using the internal LCD heater. This can be programmed to be ON or OFF or set to automatically turn on or off as the temperature changes. However, if you are powering your unit from internal AA cells, this can dramatically decrease battery life.
- By powering ARGO NAVIS™ from the external DC power source. This provides additional internal power dissipation that assists in elevating the temperature of the LCD.
- By brightening the display. This results in more heat being internally dissipated. However, if you are powering your unit from internal AA cells, this can dramatically decrease battery life.
- By thermally insulating or externally heating your ARGO

NAVIS™ unit. By keeping the unit inside a cloth or wool cover, or covering it with some other insulating material, internally generated heat will be trapped inside longer. Alternatively, you can use an external heat source, such as a dew heater, to help elevate the temperature of the unit in freezing temperatures.

In extremely cold temperatures, a combination of these methods might be employed.

### Using SETUP LCD HEATER

Enter the MODE SETUP menu then spin the **DIAL** until you see -

**SETUP LCD HEATER**

then press **ENTER**. The display will indicate the current heating policy. For example -

**LCD HEATER=OFF**

which is the factory default. Spinning the **DIAL** a detent 'click' at a time cycles the policy to be either OFF, ON, or AUTO.

AUTO will turn on at 2°C (35.6°F) and off at 3°C (37.4°F).

When you have set the desired policy, press **EXIT** or **ENTER**. If you have changed the value from what it originally was, ARGO NAVIS™ will save the new setting into its memory (EEROM device).

See also [SETUP BRIGHTNESS](#)



ARGO NAVIS™

## SETUP LOAD CAT

### Function

You should place ARGO NAVIS™ into the SETUP LOAD CAT state whenever you wish to [load](#) or [delete asteroid](#), [comet](#), [satellite](#) or [user catalogs](#), or [send or receive setup files](#) via your PC.

Doing so ensures that ARGO NAVIS™ will not attempt to access these catalogs while you are loading, deleting or [modifying](#) them.

You should also place ARGO NAVIS™ into the SETUP LOAD CAT state whenever you wish to save or load any of your EEROM device settings to or from your PC.

[ARGONAUT™](#) is a supplied utility program that runs on your PC. It can perform the loading or deleting of the catalogs via either one of the unit's [serial ports](#). ARGO NAVIS™ will not allow any catalog to be loaded unless it is in the SETUP LOAD CAT state.

When [catalogs are being loaded](#), ARGO NAVIS™ places them into its RAM (Random Access Memory). When the ARGONAUT™ utility instructs it to do so, ARGO NAVIS™ then commits the catalogs into its [FLASH](#) memory so that they will be retained even when the unit is powered off. The operation of committing the catalog data to the FLASH memory takes ARGO NAVIS™ a second or two. In that brief time, ARGO NAVIS™ is not able to perform any other task. For that reason any alignment that you may have performed might be invalidated, because ARGO NAVIS™ might have missed the fact that the telescope moved. It is

therefore a good idea to re-align your unit, if need be, after loading new catalogs.

You should place ARGO NAVIS™ into the SETUP LOAD CAT state whenever you [send or receive setup files](#) via your PC.

For [upgrading new firmware](#), you do not place the unit into the SETUP LOAD CAT state. Instead you need to put the unit into the [BOOT LOADER](#) state. See the [Transferring firmware files](#) page for details.

### Using SETUP LOAD CAT

Enter the MODE SETUP menu then spin the **DIAL** until you see -

**SETUP LOAD CAT**

Then press **ENTER**. The display will then show -

**LOAD CATALOG  
READY**

The unit is now ready for catalogs to be loaded. Use ARGONAUT™ to begin your transfer.

While the transfer is occurring, ARGONAUT™ will display informational, warning and error messages in its Status window and show the transfer progress on its Progress Bar. Messages will also be displayed on the bottom line of the unit's display. Some examples follow - In the case of a User catalog transfer you would see the message -

**LOAD CATALOG  
USER LOAD...**



Remember, the catalogs will not actually be committed to FLASH until ARGONAUT™ sends a write command. In the case of a User catalog being written you would briefly see -

LOAD CATALOG  
USER WRITE...

In the case of an incorrectly formatted file, the display will show -

LOAD CATALOG  
FORMAT ERROR !

An invalid Right Ascension field in a User catalog might show -

LOAD CATALOG  
RA VALUE ERROR !

An invalid Declination field in a User catalog might show -

LOAD CATALOG  
DEC VALUE ERROR!

An invalid object type in a User catalog will show -

LOAD CATALOG  
USER BAD TYPE

An out of range magnitude in a User catalog will show -

LOAD CATALOG  
MAG VALUE ERROR!

When there is an unexpected command, the display will show -

LOAD CATALOG  
COMMAND ERROR !

Many other error messages can appear and they are hopefully self-explanatory.

When purging a Comet catalog, the display will show -

LOAD CATALOG  
COMET PURGE...

When a User catalog transfer is complete, the display will show -

LOAD CATALOG  
USER DONE

At this time, or in fact at any time during the transfer, if you press **EXIT** or **ENTER**, ARGONAUT™ will briefly show -

LOAD CATALOG  
INITIALIZING ...

The loaded catalog entries should then appear in MODE CATALOG.

If you pre-empted the loading of catalogs by pressing **ENTER** or **EXIT** in the middle of a transfer, simply re-enter the SETUP LOAD CAT menu and the transfer will continue seamlessly from where you left off.

#### See also

[MODE SETUP](#)

[SETUP SERIAL](#)

[Argonaut software utility](#)



ARGO NAVIS™



## SETUP LOCATION

### Function

SETUP LOCATION allows you to store the names, latitudes and longitudes of up to 10 locations from which you observe. It also allows you to set your current observing location. ARGO NAVIS™ does not require you to set your location, date or time to operate, however, doing so brings about other features and benefits, including -

- The HORIZON MASK filtering option will be applied correctly in [MODE IDENTIFY](#) and [MODE TOUR](#) assuming also that you have set the correct date and time.
- If in [SETUP GUIDE MODE](#) the GUIDE BELOW HORZ setting has been set TO H INDICATOR ON, then an 'H' symbol will appear on the GUIDE mode display whenever an object is computed to be below the computed horizon, which in turn also assumes that you have [set the current date and time](#).
- The Local Apparent Sidereal Time (LAST) will be available to you in [MODE SIDEREAL](#) if you have also set the current date and time;
- The topocentric azimuth and altitude will be available to you in [MODE AZ ALT](#) assuming you have also set the current date and time and have performed a valid star alignment.
- Correction for atmospheric refraction will be made while you point your scope assuming you have also set the date and time

and assuming you have turned refraction correction ON in the [SETUP REFRACTION](#) sub-menu.

- The position of earth orbiting satellites can be computed assuming you have also set the current date and time.
- When the [SETUP MOUNT](#) type is set to FORK EXACT ALIGN or GEM EXACT ALIGN, the DAF and TF mount error terms can be used. See [SETUP MNT ERRORS](#) for details.
- When the [SETUP MOUNT](#) type is set to FORK EXACT ALIGN or GEM EXACT ALIGN, the correction applicable to the MA & ME mount error terms will be correctly reported. See [SETUP MNT ERRORS](#) for details.
- If you have a [ServoCAT™ GOTO and track system](#), ARGO NAVIS™ will provide horizon limit checking when running the "[servocat](#)" [STARTUP](#) command on the ARGO NAVIS™ serial port. Horizon limit checking also assumes you have set the current date and time.

### Using SETUP LOCATION

Enter the MODE SETUP menu then spin the **DIAL** until you see -

**SETUP LOCATION**

Then press **ENTER**, where you will then see a location name such as this -

**NOWHERE, ATLANTIC**



If you turn the **DIAL** you will then see the names of 10 locations. If you happen to live in one of them, simply hit **EXIT** while its name appears in the display and you are done.

Chances are, however, that you do not live in any of the locations indicated. This is not a problem, since you can edit the locations to places that you observe from. For example, say you are unlikely to do any observing from Mawson Base in Antarctica. Let us edit the 'MAWSON BASE' location to 'HOME'.

While in MODE LOCATION, Turn the **DIAL** until

**MAWSON BASE**

appears on the display The whole line will be flashing.

Now press the **ENTER** button. You have now entered location name edit mode. The 'M' character will be flashing indicating that the cursor is at that location. Turn the **DIAL** anti-clockwise until the letter 'H' appears, then press **ENTER** to advance to the next letter, which is an 'A'. Turn the **DIAL** in either direction to make it an 'O', press **ENTER**, and so on until you have spelt out the word 'HOME'. Continue to erase the rest of the characters in the old MAWSON BASE name by turning them into SPACES. The SPACE character is found just after the letter 'Z' if you are turning the **DIAL** clockwise. When you have erased the last character, press **ENTER** three times until the display shows this

**LAT=67:35:59 S**  
**LONG=062:53:00 W**

The top line is the latitude of Mawson Base which you will now change to your local latitude. To determine your local latitude, consult an atlas or one of the many location databases (such as [www.heavens-above.com](http://www.heavens-above.com)) available on the internet. Unless you plan on observing satellites, or accurately knowing your Local Apparent Sidereal Time (LAST), don't be too concerned if you cannot determine the exact co-ordinates of your location. Within a degree or so should be fine for most situations.

Using the **DIAL** and **ENTER** button, edit the latitude fields to values appropriate for your observing location. Latitude is displayed in terms of degrees:minutes:seconds or degrees.decimal degrees either North or South of the Earth's equator. Change the first colon character ':' to a decimal point '.' if the latitude available to you is in degrees.decimal degrees format. Change the 'S' to an 'N' depending upon whether your location is in the Northern or Southern Hemisphere.

After editing the North/South field, pressing **ENTER** again will allow you to begin editing the longitude on the bottom line of the display.

Edit it as you did the latitude, replacing the fields with values appropriate to your observing location. Longitude is displayed in terms of degrees:minutes:seconds or degrees.decimal degrees either East or West of Greenwich. Change the first colon character ':' to a decimal point '.' If the latitude is available to you is in degrees.decimal degrees format. Change the 'W' to an 'E' depending upon whether your location is East or West of the



Greenwich Meridian. For example, if you live in the United States or Canada, your location will be West of Greenwich so you will enter a 'W'. If you live in Australia, for example, your location will be East of Greenwich so you will enter an 'E'.

When you have edited the last longitude field, press **ENTER**. The display will then show

**HOME**

where the word HOME will be flashing. Press **EXIT** to set HOME as your observing location. The display will briefly show -

**SAVING ...**

and then the words -

**INITIALIZING ...**

in the lower half of the display before returning to the SETUP sub-menu with the message

**SETUP LOCATION**

You have now successfully set your location.

While the **SAVING...** message appeared, ARGO NAVIS™ saved your location settings into its memory (EEROM device). While the **INITIALIZING ...** message appeared, ARGO NAVIS™ re-initialized such things as the current Local Apparent Sidereal Time (LAST).

You can edit as many of the locations in the SETUP LOCATION menu as you desire. Whenever you change observing location, simply enter the SETUP LOCATION menu, turn the **DIAL** until the name of the

location you are observing from appears and then hit **EXIT**.

As a convenience, when editing the name of a location, ARGO NAVIS™ will automatically transition to the latitude/longitude sub-menu whenever you enter two consecutive blank spaces after the name of the location.

When you edit the name of a location and then press **EXIT**, ARGO NAVIS™ automatically sorts the location entries alphabetically for your convenience.

Remember, in order to perform an alignment and to use most of the features of ARGO NAVIS™ you don't need to set your time zone, date, time or location unless you also decide to turn on refraction modelling correction, or perform a mount error sample test on a GEM EXACT ALIGN or FORK EXACT ALIGN mount, or use the DAF or TF mount error terms either when computing or using a model, or would like some of the other features or benefits previously mentioned.

Note that when you exit from SETUP LOCATION that if you have changed your latitude and longitude, any prior star alignment you may have performed will be invalidated, including any FIX ALT REF, ALIGN or ALIGN STAR operation.

You can also view your current location using [MODE SIDEREAL](#).

#### See also

[MODE SIDEREAL](#)

[MODE TIME](#)

[MODE SETUP](#)

[SETUP DATE/TIME](#)

[SETUP REFRACTION](#)



**ARGO NAVIS™**

## SETUP MOUNT

### Function

SETUP MOUNT allows you to specify what type of mount your telescope is on. You must set this before you can begin to use ARGO NAVIS™

### Using SETUP MOUNT

Enter the MODE SETUP menu then spin the DIAL until you see -

**SETUP MOUNT**

then press **ENTER**. The display will indicate the current mount type setting.

For example -

**ALTAZ/DOBSONIAN**

indicates that the current mount is of the Altitude/Azimuth type. Spinning the DIAL a detent 'click' at a time cycles the mount type. The mount types are listed in the table below.

When you have set the desired mount, press **EXIT** or **ENTER**. If you have changed the mount type from what it originally was, ARGO NAVIS™ will save the new setting into its memory (EEROM device). It will also invalidate any previous alignment you have made.

Setting a mount type that requires a [FIX ALT REF](#) step as part of the alignment procedure will cause the [MODE FIX ALT REF](#) menu to appear in the top level menu.

See also

[MODE SETUP](#)

Menu selection	When to use	Number of alignment stars required
<b>ALTAZ/DOBSONIAN</b>	For altitude/azimuth mounts such as Dobsonians (but not on equatorial tables)	<a href="#">FIX ALT REF</a> step plus 2 <a href="#">alignment stars</a>
<b>EQ TABLE EXACT</b>	For altitude/azimuth mounts mounted on top of an accurately polar aligned equatorial table	<a href="#">FIX ALT REF</a> step plus 2 <a href="#">alignment stars</a> . See also <a href="#">SETUP EQ TABLE</a>
<b>FORK EXACT ALIGNED</b>	For any accurately aligned equatorial mount, such as a fork mount, but not a German equatorial	One <a href="#">alignment star</a>
<b>FORK ROUGH ALIGN</b>	For any roughly aligned equatorial mount, such as a fork mount, but not a German equatorial	<a href="#">FIX ALT REF</a> step plus 2 <a href="#">alignment stars</a>
<b>GEM EXACT ALIGN</b>	For an accurately polar aligned German equatorial	One <a href="#">alignment star</a>
<b>GEM ROUGH ALIGN</b>	For a roughly aligned German Equatorial	<a href="#">FIX ALT REF</a> step plus 2 <a href="#">alignment stars</a>



ARGO NAVIS™

## SETUP MNT ERRORS

### Function

SETUP MNT ERRORS forms the control center for the powerful ARGO NAVIS™ *Telescope Pointing Analysis System*™ (TPAS™), which allows you to measure, model, compute, analyse and store the values of various types of systematic errors in your mount/telescope.

Using its advanced “*pointing kernel*”, ARGO NAVIS™ will attempt to compensate for these errors when you align and point your telescope.

The system works with all mount types. For FORK EXACT ALIGN and GEM EXACT ALIGN mounts, the system has the additional benefit of being able to assist you with polar alignment.

### About pointing errors

You may be reading this section because you have a pointing issue.

Therefore, before detailing how to use the functionality of SETUP MNT ERRORS, it is worth reviewing here the subject of pointing errors in general.

Historically, some telescopes used mechanical scales known as “setting circles” to assist the operator in determining the co-ordinates of where the telescope was pointing. Whether one is using some mechanical measuring device or the readout of a digital telescope computer, such as the ARGO NAVIS™, at any one place in the sky, the angular difference between where the telescope “thinks” it is pointing and where it is actually pointing, is known as a “pointing error residual” or simply “residual”.

For practical purposes, when you use ARGO NAVIS™ to locate or identify objects, pointing error issues can usually be split into two broad categories –

1. Unit setup errors, operator errors and encoder installation errors. These types of errors cannot be corrected by the features of SETUP MNT ERRORS.
2. Mount/telescope fabrication errors. Some of these types of errors can be compensated for by the features of SETUP MNT ERRORS.

### Category 1 errors

Irrespective of how much experience you have had with the system, you should always consider category ‘1’ errors first, as they by far dominate the number of ‘real world’ pointing issues.

Common category ‘1’ unit setup errors include incorrect settings in [SETUP AZ STEPS](#), [SETUP ALT STEPS](#), [SETUP DATE/TIME](#) and [SETUP LOCATION](#).

For example, the number of encoder steps and in particular the encoder direction sense signs need to be [correctly established](#).

When [SETUP REFRACTION](#) is switched to ON, ARGO NAVIS™ assumes that you have correctly set your time zone, date time and location in order to help it determine where your local horizon is. If they are incorrectly set, then the pointing corrections this feature provides will be incorrectly applied, perhaps being quite large in some areas of the sky.





In this regard, a common error for users who live in North, Central & South America, is to enter a positive time zone offset into SETUP DATE/TIME. Users in these parts of the world are West of the Greenwich meridian and will therefore have negative time zone settings. If changing your time zone setting, you should then check that the local date and time is correctly set.

Similarly, when [SETUP REFRACTION](#) is set to ON, you should also check that you have correctly entered your observing location's latitude and longitude in [SETUP LOCATION](#), paying particular attention as to whether you live North or South of the Equator and East or West of the Greenwich Meridian.

Common category '1' operator errors include incorrect setting of the [ALT REF](#) point on mounts that require a two-star alignment and incorrect identification of alignment stars.

If your mount is of a type that requires a [FIX ALT REF](#) to be performed, you are strongly encouraged to review and use the AUTO ADJUST feature. See also [SETUP ALT REF](#) for details. Using AUTO ADJUST ON can sometimes bring about a dramatic improvement in pointing performance and for those mounts that have negligible fabrication errors, its use alone may suffice to achieve excellent pointing performance.

Common category '1' encoder installation errors include encoder shafts that slip due a loose setscrew or problem with the coupling.

For example, some couplings that use rubber 'O'-rings can become stiff in low temperatures and allow the encoder shaft to slip.

For Dobsonian telescope owners, you should check that the Az pivot bolt is secured firmly to the base of the ground board and that the encoder shaft is held captive with the Az pivot bolt. When the Az pivot bolt on a Dobsonian is not secured tightly to the base of the ground board, it can give rise to some back-and-forth rotational 'play' in the bolt. This latter effect falls into a class of errors termed by the technical name of 'hysteresis'.

For encoder installations that use gears, check that the setscrews are tightened so that the gears do not slip on their shafts or bearings.

Some installations have brackets, known as 'tangent arms', fabricated either from metal or plastic, that go from the body of the encoder to some fixed point on the mount. You should check that the hex nut above the shaft of the encoder holds the tangent arm securely. You should check that the tangent arm is not pushing the encoder to one side, thus causing the encoder shaft to be no longer parallel with the coupling to which it is attached.

To help identify encoder installation errors, it is strongly recommended that you perform a 'daylight encoder test'.

#### **Daytime encoder test**

The following describes how to perform a daytime encoder test.

During the day, using a high-powered eyepiece or cross-hair reticle, center a distant fixed terrestrial object.

Power on ARGO NAVIS™ and after it has initialized, spin the **DIAL** until the display reads –

**MODE ENCODER**



**ARGO NAVIS™**

then press **ENTER**. Now spin the **DIAL** until the display reads –

AZ/ALT ENC STEPS  
+0000 \*0000

When in this mode, the value of Azimuth steps range from 0 to the number of steps set in SETUP AZ STEPS minus 1. Altitude steps range from 0 to the number of steps set in SETUP ALT STEPS minus 1.

If your mount is of the style that allows you to lock the Alt (or Dec) axis, lock it.

Take note of the left-hand displayed value, which is the Az (or RA) encoder count.

Rotate the mount through 360° in Az (RA) and re-center the object. Take note of the displayed Az encoder count value. Ideally, it should be within an encoder step or two of the value from which you started. Keep in mind that the displayed count “wraps”, so that, for example, a value that is equivalent to the number of steps set in SETUP AZ STEPS minus 1 is only 1 step away from a count of zero.

Now exercise the scope back-and-forth in Az (RA) to attempt to induce any potential encoder shaft slippage error, or the like. Again, re-center the object and check that the displayed value has returned to within a step or two of what it originally was.

Now take note of the right-hand displayed value, which is the Alt (or Dec) encoder count.

If your mount is of the style that allows you to lock the Az (or RA) axis, lock it.

Now exercise the scope up-and-down in Alt (Dec) to attempt to induce any

potential encoder shaft slippage error, or the like. Again, re-center the object and check that the displayed value has returned to within a step or two of what it originally was.

To diagnose for hysteresis effects, carefully observe the display in [MODE ENCODER](#) whilst moving the scope to-and-fro. When you begin to move the scope, look for any noticeable delay or “lag” from the time the scope starts to move to the time MODE ENCODER registers motion.

Start by rotating the mount in one direction, then stopping and reversing the direction of travel. If you notice the above mentioned lag effect from when the scope begins to move, this is a telltale sign of hysteresis. It is best rectified by inspecting your encoder mounting hardware for any ‘play’ and then applying a mechanical fix.

### Category 2 errors

The following discussion should be regarded as an advanced topic. It assumes you are completely familiar with setting-up, aligning and guiding with your ARGO NAVIS™ and that you have used it successfully for several observing sessions. If not, it is recommended that you review the section on [Initial setup of ARGO NAVIS™](#) and the section on [Alignment procedures](#).

Category 2 errors can be divided into three sub-categories –

- a. Random errors. (Neither ARGO NAVIS™, nor any other system, can ever model or compensate for errors that are random or non-repeatable in nature).



ARGO NAVIS™



- b. Systematic errors of a type for which ARGO NAVIS™ provides no support.
- c. Systematic errors of a type that ARGO NAVIS™ can model and compensate for.

Examples of Category 2a errors include a sudden mirror-flop, or a truss pole on a Dobsonian that is not secured in its block allowing the top-end to 'flop'. These are always best addressed by fixing the problem at its source.

Category 2c errors can be computed using the features available in SETUP MNT ERRORS and the remaining discussion will be devoted to this topic.

Even multi-billion dollar professional telescopes have some intrinsic systematic fabrication error in their mounts.

### The TPAS™ Approach

TPAS™ can help you measure pointing error residuals, then compute and compensate for many of the more common types of systematic fabrication errors.

Internally, TPAS™ has a mathematical formula for each of the supported errors. Such a formula is referred to as a "term". A set of terms that work in unison forms what is referred to as a "model" and when applied, such a model can be used to help improve the pointing of your telescope.

The TPAS™ approach involves you performing an initial alignment of the unit and then centering stars in the eyepiece and sampling their positions. Ideally, the stars sampled will be distributed uniformly across the sky.

Once you have sampled a sufficient number of stars (anywhere from 2 to 150, depending upon your requirements), you can define a model and then have TPAS™ compute the values of each of the terms in the model.

When TPAS™ computes the value of the terms of the defined model, it also provides you with important statistical feedback that will assist you in determining the merit of the overall model and the merit of each of the individual terms.

Depending upon the values provided by this statistical feedback, you might then decide to either apply this model as your current pointing model, or to reject the model and try another. For example, you might decide to experiment and add or remove terms from your model. TPAS™ allows you to do this in a fast and convenient manner.

Once you have determined a model that provides the best pointing performance for your telescope, you can save the model in the unit's non-volatile memory (EEROM device) and then re-use it on subsequent nights. If no changes are made to the telescope, then many terms also should remain the same from session to session. Some terms, however, will not be persistent between sessions, but you can quickly re-establish these by performing a short sampling run at the beginning of the night.

TPAS™ works on all mount types, whether they are an equatorial mount such as Fork or a GEM or an Alt/Az type such as a Dobsonian.

Pointing errors interact with one another in very complex ways. One



ARGO NAVIS™

remarkable aspect of **TPAS**<sup>™</sup> is that it can untangle each of the error terms.

**TPAS**<sup>™</sup> will compute the value of each of these terms so that the model you have defined provides the best possible fit to your sampling data.

### Root Mean Square (RMS)

One statistical measure that the system provides is a value known as the Root Mean Square (RMS).

Mathematically, RMS is defined as the square root of the mean (average) of the squares of the pointing error residuals.

Suffice to say, RMS provides a measure by which one can estimate the pointing performance of the telescope.

You will undoubtedly be interested in the pointing performance of the telescope when no modelling is applied (known as raw RMS pointing performance) and the pointing performance after a model is applied (known as modelled RMS pointing performance).

Just as an individual pointing error residual is expressed as an angle, so is RMS. The smaller the RMS value, the better the performance.

The RMS value can be thought of as the radius of a circle. As a rule of thumb, for any given RMS value, approximately 68% of stars in the sampling data will fall within a circle whose radius is equivalent to the RMS of that data.

Figures 11 and 12 are example two-dimensional plots of pointing error residuals, known as “scatter diagrams”.

Each of the small squares represents a sampled star position, 46 in all. These sampled positions were more or less

evenly distributed in azimuth and altitude across the whole-sky to provide meaningful data about the telescope’s whole-sky pointing performance.

The distance a square is from the center of the circles represents the magnitude of that star’s error residual. The direction from the center of the circles represents the direction of the error residual.

The inner circle has a radius equivalent to the RMS of the data. The outer circle has a radius that encompasses all the residuals.

[Figure 11](#) shows the raw pointing residuals of a real telescope. The raw RMS for the 46 stars was analysed by **TPAS**<sup>™</sup> to be 14.5’ (arcminutes) and some residuals were nearly 26.7’ (outer circle). This represents the raw pointing performance of this particular telescope when no mount error modelling has been applied.

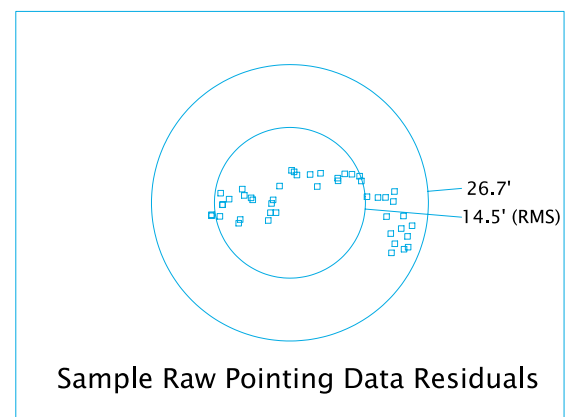

**Figure 11**

[Figure 12](#) shows the fitted pointing residuals after a model was fitted by **TPAS**<sup>™</sup>. The fitted RMS drops to 2.1’ (about the same resolution as one step of

a 10,000-step encoder, which this particular telescope was fitted with) and the largest pointing residual dropped to less than 4.5'.

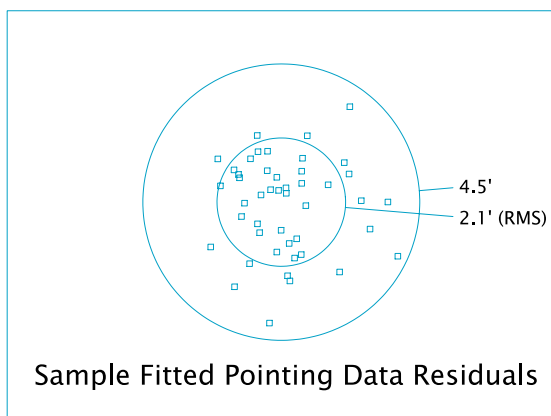

**Figure 12**

These two diagrams therefore help illustrate the significance of the statistical measure known as RMS and provide an example of how **TPAS™** improved the pointing performance of this particular telescope.

It may be convenient to imagine the circles represent the Field Of View (FOV) of an eyepiece. It should therefore be apparent that after a model was fitted, more objects fell within the FOV of a high-powered eyepiece.

### Pointing Terms

The **TPAS™** philosophy is, as far as possible, to provide pointing correction terms that describe real effects, such as geometrical misalignments and gravitational flexures.

Some advantages of this approach include –

- The model may help you identify, diagnose and correct mechanical deficiencies with your telescope.

- If you make no changes to your telescope, some terms will be persistent from session to session. This allows you to perform a short sampling run to re-synchronize those terms that do not persist from session to session.
- For exact-align mounts, polar misalignment in both axes can be determined using two specific error terms.

Table 1 lists the error terms supported by **TPAS™**.

The first column lists the abbreviated name of the term. These abbreviations are identical to that used by many professional observatories and are thus a de facto “industry standard” nomenclature. **ARGO NAVIS™** also displays abbreviated term names using this same convention.

Whenever **ARGO NAVIS™** displays the name of a term in a longer fashion, it does so according to the “long-names” shown in the second column.

The third column contains the full name and a detailed description of each term. Note that the error terms that **TPAS™** will make available to you depend on your mount type setting in [SETUP MOUNT](#).

For example, if the mount type is set to **FORK EXACT ALIGN**, additional terms are available compared to when the mount type is set to **FORK ROUGH ALIGN**. Examples of additional terms in this instance are the polar misalignment terms (**MA & ME**), flexure terms (**FO & TF**) and RA axis harmonic terms (**HCEC & HCES**).



Table 1

Term abbreviation on ARGO NAVIS™	Displayed long-name on ARGO NAVIS™	Term full name and description
CA	COLLIMATION ERR	<p><b>Collimation Azimuth</b> For an Alt/Az mount, the non-perpendicularity between the pointing axis and the Alt axis.</p> <p>Results in a left-right shift in the sky that is constant for all Altitudes.</p> <p>Can result from many causes such as the scope's optical axis not being perpendicular to its Alt axis, the scope's optical axis not being parallel to its pointing axis, misaligned optics, etc.</p> <p>If the scope had this error on its own, there will be an area around the pole of the scope (the zenith) that the scope cannot point.</p>
CH	COLLIMATION ERR	<p><b>Collimation Hour Angle</b> For an Equatorial mount, the non-perpendicularity between the pointing axis and the Dec axis.</p> <p>Results in an East-West shift in the sky that is constant for all Declinations.</p> <p>On a Fork mount, when it is pointing above the pole, a positive value of CH moves the pointing axis West of where it would otherwise be.</p> <p>On a GEM, if the scope is pointing West of the meridian, a positive value of CH means it is pointing further West than it would be if CH were zero. If the scope is pointing East of the meridian, a positive value of CH means it is pointing further East than it would be if CH were zero.</p> <p>CH can result from many causes such as the scope's optical axis not being perpendicular to its Dec axis, the scope's optical axis not being parallel to its pointing axis, misaligned optics, etc. Note that</p>



ARGO NAVIS™

		<p>rotating a tube within the rings of a mount, or rotating a diagonal mirror will affect this term.</p> <p>If the scope had this error on its own, there will be an area around the pole to which the scope cannot point.</p>
DAF	DEC AXIS FLEXURE	<p><b>Declination Axis Flexure</b> The sag downward under gravity of the Dec axis on a GEM.</p>
DCEC	DEC CENTER COS	<p><b>Declination Centering Error Cosine</b> For an equatorial mount, cosine component of a once-per revolution cyclic effect produced by miscentered Dec encoder or Dec bearing eccentricity.</p>
DCES	DEC CENTER SIN	<p><b>Declination Centering Error Sine</b> For an equatorial mount, sine component of a once-per revolution cyclic effect produced by miscentered Dec encoder or Dec bearing eccentricity.</p>
ECEC	EL CENTER COS	<p><b>Elevation Centering Error Cosine</b> For an Alt/Az mount, cosine component of a once-per revolution cyclic effect produced by miscentered Alt encoder or Alt bearing eccentricity or tube flexure.</p>
ECES	EL CENTER SIN	<p><b>Elevation Centering Error Sine</b> For an Alt/Az mount, sine component of a once-per revolution cyclic effect produced by miscentered Alt encoder or Alt bearing eccentricity or gravitational flexure.</p>
FO	FORK FLEXURE	<p><b>Fork flexure</b> Flexure of fork arms in Fork mount.</p>
HCEC	HA CENTER COS	<p><b>Hour Angle Centering Error Cosine</b> For an equatorial mount, cosine component of a once-per revolution cyclic effect produced by miscentered RA encoder or RA bearing eccentricity.</p>
HCES	HA CENTER SIN	<p><b>Hour Angle Centering Error Sine</b> For an equatorial mount, sine component of a once-per revolution cyclic effect produced by miscentered RA encoder or RA bearing eccentricity.</p>
ID	DEC INDEX ERROR	<p><b>Index error Declination</b> For an equatorial mount, the Dec encoder zero point correction.</p> <p>ID brings about a fixed North-South offset and on</p>



		<p>FORK ROUGH ALIGN and GEM ROUGH ALIGN mount types, combines with the ALT REF value to help provide a more accurate Alt encoder zero reference point than the ALT REF value alone.</p> <p>ID is not persistent from session to session and for this reason should not be saved.</p> <p>Probably best described as a term that helps provide a best fit for all other terms, given that the mount is initially aligned on arbitrary stars.</p>
IE	INDEX ERROR EL	<p><b>Index error Elevation</b> For an Alt/Az mount, the Alt encoder zero point correction.</p> <p>IE brings about a fixed vertical offset and combines with the ALT REF value to help provide a more accurate Alt encoder zero reference point than the ALT REF value alone.</p> <p>IE is not persistent from session to session and for this reason should not be saved.</p> <p>Probably best described as a term that helps provide a best fit for all other terms, given that the mount is initially aligned on arbitrary stars.</p>
IH	HA INDEX ERROR	<p><b>Index error Hour angle</b> For a GEM EXACT ALIGN or FORK EXACT ALIGN mount, the RA encoder zero point correction.</p> <p>IH is not persistent from session to session and for this reason should not be saved.</p> <p>Probably best described as a term that helps provide a best fit for all other terms, given that the mount is initially aligned on arbitrary stars.</p> <p>A small error in the time setting of <a href="#">SETUP DATE/TIME</a> or a small error in site longitude set in <a href="#">SETUP LOCATION</a> is indistinguishable from this term.</p>
MA	POLAR LEFT-RIGHT	<p><b>polar Misalignment Azimuth</b> For an equatorial mount, the misalignment of the polar axis left or right of the celestial pole.</p>





		In either hemisphere, a positive MA corresponds to the mount's pole being to the right of the Celestial Pole.
ME	POLAR VERTICAL	<p><b>polar Misalignment Elevation</b> For an equatorial mount, the misalignment of the polar axis above or below the Celestial Pole.</p> <p>In the Northern Hemisphere, a positive ME means the mount's pole is below the refracted North Celestial Pole.</p> <p>In the Southern Hemisphere, a positive ME means the mount's pole is above the refracted South Celestial Pole.</p>
NPAE	NON-PERPEN. AXES	<p><b>Non Perpendicular Axes Error</b> For an Alt/Az mount, the non-perpendicularity between the Az and the Alt axes.</p> <p>Produces a shift that is zero at zero Altitude (i.e. the horizon) and reaches a maximum at the pole of the scope (i.e. the zenith).</p> <p>If the scope had this error on its own, there would be an area around the pole of the scope (the zenith) to which it could not point.</p>
NP	NON-PERPEN, AXES	<p><b>Non Perpendicular axes error</b> For an equatorial mount, the non-perpendicularity between the RA and the Dec axes.</p> <p>Produces a shift that is zero at zero Declination (i.e. the Celestial Equator) and reaches a maximum at the pole of the scope (i.e. the Celestial Pole).</p> <p>If the scope had this error on its own, there will be an area around the pole to which it could not point.</p>
TF	TUBE FLEXURE	<p><b>Tube Flexure</b> In an equatorial mount, the gravitational flexure of the tube.</p>



The following tables lists the terms available for each of the various mount types.

The tables also indicate which terms are recommended to always be used, which terms are not persistent and should never be saved and which terms may be better to re-compute from session to session with a short sampling run.

Specifically, in this last regard, the CA and CH Collimation Error terms for Alt/Az and equatorial mounts respectively, may not always be persistent in magnitude or direction from session to session, particularly if the scope is re-collimated, the optical tube rotated in the rings of a mount, a mirror diagonal rotated, etc.

Therefore, it may be best not to save the CA or CH term and instead re-compute it each session by performing a short sampling run.

For EXACT ALIGN mounts, the decision to save the polar-misalignment terms, MA and ME, for use during a subsequent session, will likely depend on whether your mount is portable or whether it is permanently mounted on a pier.

Other terms may or may not be persistent to the same order depending upon how much the telescope is changed between sessions.

For example, if a Dobsonian telescope is disassembled and then re-assembled from session to session and had an encoder centering error, then the ECEC and ECES terms might change each time the Alt encoder is re-attached.

However, ECEC and ECES also model gravitational flexure (i.e. flexure on an

Alt/Az mount has a mathematical signature indistinguishable to an encoder centering error).

If the ECEC and ECES terms are predominantly the result of gravitational flexure, then they may be more consistent from session to session.

In this regard, though ARGO NAVIS™ does not require you to level the mount in order to align, locate or identify objects, assuring that the mount is reasonably level may help provide gravitational flexure terms that are more consistent between sessions.



**Table 2**

<b>ALTAZ/DOBSONIAN or EQ TABLE EXACT</b>			
<b>Terms</b>	<b>Always Use</b>	<b>Not Persistent between sessions (i.e. do not SAVE)</b>	<b>Often Persistent between sessions (i.e. may be OK to SAVE)</b>
CA		NOT ALWAYS	NOT ALWAYS
ECEC			YES
ECES			YES
IE	YES	YES	
NPAE			YES

**Table 3**

<b>FORK ROUGH ALIGN or GEM ROUGH ALIGN</b>			
<b>Terms</b>	<b>Always Use</b>	<b>Not Persistent between sessions (i.e. do not SAVE)</b>	<b>Often Persistent between sessions (i.e. may be OK to SAVE)</b>
CH		NOT ALWAYS	NOT ALWAYS
DCEC			YES
DCES			YES
ID	YES	YES	
NP			YES

**Table 4**

<b>FORK EXACT ALIGN</b>			
<b>Terms</b>	<b>Always Use</b>	<b>Not Persistent between sessions (i.e. do not SAVE)</b>	<b>Often Persistent between sessions (i.e. may be OK to SAVE)</b>
CH		NOT ALWAYS	NOT ALWAYS
DCEC			YES
DCES			YES
HCEC			YES
HCES			YES
FO			YES
ID	YES	YES	
IH	YES	YES	
MA	YES	YES if mount portable	YES if mount on pier
ME	YES	YES if mount portable	YES if mount on pier
NP			YES
TF			YES



**ARGO NAVIS™**

Table 5

GEM EXACT ALIGN			
Terms	Always Use	Not Persistent between sessions (i.e. do not SAVE)	Often Persistent between sessions (i.e. may be OK to SAVE)
CH		NOT ALWAYS	NOT ALWAYS
DAF			YES
DCEC			YES
DCES			YES
HCEC			YES
HCES			YES
ID	YES	YES	
IH	YES	YES	
MA	YES	YES if mount portable	YES if mount on pier
ME	YES	YES if mount portable	YES if mount on pier
NP			YES
TF			YES

**Power recommendations before performing a large star pointing run**

If you are considering performing a large pointing test in order to help diagnose the fabrication errors in your telescope, then it is highly recommended you install a fresh set of batteries in the unit or power the unit from an external DC power source. A large pointing test can take several hours and if the power should fail, your valuable pointing data will be lost.

**Using SETUP MNT ERRORS**

Before using SETUP MNT ERRORS, you should ensure that your local time zone, date and time is set in [SETUP DATE/TIME](#) and that the local location is set in [SETUP](#)

[LOCATION](#). You should then switch refraction modelling ON in [SETUP REFRACTION](#).

In [SETUP GUIDE MODE](#), you might also find it convenient to set the GUIDE DECIMAL setting to 2 DECIMAL PLACES.

Once you have performed the above steps, enter the [MODE SETUP](#) menu, then spin the **DIAL** until you see -

**SETUP MNT ERRORS**

then press **ENTER**. The display might then show -

**ACQUIRE DATA**

where the top-line of the display will be flashing. By spinning the **DIAL** a detent 'click' at a time, the top line of the display can be cycled as follows -



- ACQUIRE DATA
- COMPUTE ERRORS
- DEFINE MODEL
- REVIEW DATA
- SET ERROR VALUES

Each of these corresponds to a submenu, of which the following paragraphs provide an initial brief overview.

The ACQUIRE DATA submenu allows you to switch SAMPLE MODE either ON or OFF. When SAMPLE MODE is ON, an additional submenu will appear when you press **ENTER** in GUIDE mode.

The COMPUTE ERRORS submenu allows you to compute the values of terms you have defined to be computed in the DEFINE MODEL submenu. It also reports to you the RMS value before and after the fit, the 'Population Standard Deviation' (PSD) before and after the fit and another statistical measure, known as the standard deviation, of each term, along with other useful diagnostic information. Once the computation is performed, it allows you to either accept (i.e. put in use and optionally save for later use) or reject the pointing model.

The DEFINE MODEL submenu allows you to define which terms you would like COMPUTE ERRORS to compute, which terms you would like to declare as constant 'fixed' values and which terms not to include in the computation at all.

The REVIEW DATA submenu allows you to examine the pointing data you have sampled. You can examine and delete entries, look at individual raw and fitted

pointing residuals for each star sampled and also examine the raw and modelled RMS values for the entire data set.

The SET ERROR VALUES submenu allows you to examine or manually edit two sets of terms. One set of terms are those that are currently in use by the 'pointing kernel'. The other set of terms are those that are saved in the unit's non-volatile memory (EEROM device) for use on subsequent observing sessions. Normally you would not manually edit either set of terms, but instead use the power and utility of the COMPUTE ERRORS function to determine and save them for you.

#### The ACQUIRE DATA submenu

Assuming you would like to perform a star-pointing test, begin by switching SAMPLE MODE to ON.

Spin the **DIAL** until you see –

ACQUIRE DATA

then press **ENTER**. The display might then show –

SAMPLE MODE=OFF

where the OFF will be flashing, Spin the DIAL until the display shows -

SAMPLE MODE=ON

then press **EXIT** or **ENTER**. If you have changed the state from what it originally was, ARGO NAVIS™ will save the new setting into its memory (EEROM device).

When SAMPLE MODE is ON, whenever the unit is in GUIDE mode and you press the **ENTER** button, a new submenu will



ARGO NAVIS™



appear. GUIDE mode is reached from [MODE CATALOG](#), [MODE IDENTIFY](#) or [MODE TOUR](#).

### Initial alignment

Align the unit as you normally would. For example, if your [mount type](#) is set as FORK EXACT ALIGN or GEM EXACT ALIGN, perform a one star alignment using either [MODE ALIGN STAR](#) or [MODE ALIGN](#).

If your mount is of any other type, you will be required to perform a [FIX ALT REF](#) step and a two star alignment.

Unless your mount type is GEM ROUGH ALIGN, you can use AUTO ADJUST ON when you perform the [FIX ALT REF](#) step, if you so choose. Part of the utility of the TPAS™ system is that once you have sampled some stars and put an initial model in use, it can further refine your ALT REF point, irrespective of your mount type, including a GEM.

### Sampling stars

Once you have aligned the system, you can then begin to start sampling some stars. The initial alignment star(s) are a good place to start.

Since the last alignment star will become the default object when you enter [MODE CATALOG](#), it is sometimes convenient to use that mode to GUIDE to that star.

For example, say the last star you aligned on was SIRIUS. Navigate to [MODE CATALOG](#) and press the **ENTER** button a successive number of times until the GUIDE mode appears in the bottom line. In this example, the display might show –

```
SIRIUS
GUIDE 0→01 0.00
```

Now press **ENTER**. The display might then show -

```
SIRIUS
DESCRIPTION
```

where the word DESCRIPTION will be flashing.

Normally at this point, rather than the word DESCRIPTION appearing, ARGO NAVIS™ would have displayed a scrolling description of the object. However, when SAMPLE MODE is ON, this new submenu appears.

By spinning the **DIAL** a detent ‘click’ at a time, the bottom line of the display can be alternated as follows –

- DESCRIPTION
- SAMPLE MNT ERROR

If you want to view the description of the object, spin the **DIAL** until the word DESCRIPTION appears and then press **ENTER**.

However, to continue with the example of sampling the star position, spin the **DIAL** until the display says SAMPLE MNT ERROR. Now center the star using a high-powered or reticle eyepiece. Then press **ENTER** to sample the star position.

For example, the display might then show, for two seconds -

```
SIRIUS
ITEM=1 Δ=30”
```

ITEM=1 denotes that this was the first item sampled.



The  $\Delta$  symbol is the capital Greek letter “Delta” and ARGO NAVIS™ uses it to denote a raw pointing residual. Thus,  $\Delta=30''$  denotes that the raw pointing error residual was 30 arcseconds.

In this example, you may be surprised that the raw pointing residual was non-zero, despite the fact this star was just aligned on. There can be several reasons for why you may see a value that is not exactly zero. One factor is due to the finite resolution of the encoders in your system. For example, the resolution of a 10,000-step encoder is approximately 2.16 arcminutes per step.

[MODE IDENTIFY](#) and [MODE TOUR](#) can also be used to assist you in sampling stars.

For example, you might point your telescope at a bright star (e.g. if you performed a two star alignment, perhaps this time, the first star you aligned on) and then using the **DIAL** and **ENTER** button you might select -

MODE IDENTIFY  
 FIND STAR  
 FAINTEST MAG +4  
 IN ANY CONSTEL  
 WITH 360° ARC

The display might then show –

CAPELLA  
 FOUND

Now press **ENTER**. The display might then show -

CAPELLA  
 GUIDE 0→02 0↓01

Now press **ENTER**. The display might then show -

CAPELLA  
 SAMPLE MNT ERROR

Center the star as accurately as possible in the eyepiece and then press **ENTER** to sample it.

[MODE TOUR](#) is particularly convenient in assisting in star pointing tests.

For example, you may decide to point the scope toward the zenith and begin a tour of bright stars from there.

To minimize the chance of misidentifying an object to sample, use only bright stars (for example, those of magnitude 6 or brighter, such as those that appear in the BRIGHT STAR catalog) and planets.

Avoid the use of –

- Non-stellar objects. For example, it can be difficult to determine the center of an extended non-stellar object. Some non-stellar objects have larger positional uncertainties, as accurate astrometric positional data may not have been available for them or their astrometric centers were determined photographically perhaps at a wavelength not easily discernable to the human eye.
- Double stars or multiple stars. It can be difficult to identify which star to center on.
- Variable stars. For example, the variable star GK PER has a maximum recorded magnitude of 0.2 but a minimum magnitude of

14. MODE IDENTIFY and MODE TOUR filter objects according to their maximum magnitude. Therefore, the system might suggest such a variable, but the star may currently be too dim to identify with any certainty.

For a long sampling run, it is recommended that you initially sample 4 stars. At that point, it is advisable to define, compute and accept an initial model. This will then provide some initial refinement of your pointing and you can then go back to your sampling run.

#### The DEFINE MODEL submenu

Enter the SETUP MNT ERROR menu and spin the **DIAL** until you see –

**DEFINE MODEL**

then press **ENTER**. Depending upon the setting in [SETUP MOUNT](#), the display might then show –

**COLLIMATION ERR**  
**CH=DON'T USE**

where the top line will be flashing. If you spin the **DIAL** a detent click at a time, you can cycle through the various terms available for your mount.

The top line of the display shows the long name of the term and the bottom line shows the abbreviated name and how it is currently defined in the model.

A term can be defined to be one of the following states –

- **COMPUTE** – The term will be computed by the **COMPUTE ERRORS** function.

- **DON'T USE** – The term will not be considered by the **COMPUTE ERRORS** function.
- **Fixed Value** – The term will be held fixed at the value specified when the **COMPUTE ERRORS** function is invoked.

To change the state of a specific term, press **ENTER** and then spin the **DIAL** to select the required state.

To edit a fixed value, press **ENTER**, then use the **DIAL** and **ENTER** button to alter the value a field at a time. Values are expressed as plus or minus minutes and decimal-minutes of arc. (There are 60 arcminutes to 1 degree).

Once you have selected the required state, then press **EXIT** or **ENTER**. If you have changed the state from what it originally was, **ARGO NAVIS™** will save the new setting into its memory (EEROM device).

Continuing with the earlier example, assume you have so far sampled 4 stars.

If your [SETUP MOUNT](#) setting is **FORK EXACT ALIGN** or **GEM EXACT ALIGN**, the number of terms that you can define as **COMPUTE** is equal to the number of stars you have currently sampled.

If your mount is of any other type, the number of terms you can define to **COMPUTE** is equal to the number of stars you have sampled minus three.

If your [SETUP MOUNT](#) setting is **FORK EXACT ALIGN** or **GEM EXACT ALIGN**, then at this point it is recommended you set the following terms to **COMPUTE** -



- DEC INDEX ERROR  
ID=COMPUTE
- HA INDEX ERROR  
IH=COMPUTE
- POLAR LEFT-RIGHT  
MA=COMPUTE
- POLAR VERTICAL  
ME=COMPUTE

All other terms should be set to DON'T USE.

If your [SETUP MOUNT](#) setting is FORK ROUGH ALIGN or GEM ROUGH ALIGN, then at this point it is recommend you set the following term to COMPUTE -

- DEC INDEX ERROR  
ID=COMPUTE

All other terms should be set to DON'T USE.

If your [SETUP MOUNT](#) setting is ALTAZ/DOBSONIAN or EQ TABLE EXACT, then at this point it is recommended you set the following term to COMPUTE -

- INDEX ERROR EL  
IE=COMPUTE

All other terms should be set to DON'T USE.

Once you have set the states of the terms as recommended, exit the DEFINE MODEL submenu by pressing **EXIT**.

### The COMPUTE submenu

Spin the **DIAL** until you see –

**COMPUTE**

then press **ENTER**. For a brief moment, the top line of the display will then show –

**COMPUTING...**

followed by -

**COMPUTATION DONE**

The bottom line of the display will begin scrolling information. Whilst the information is scrolling (to change the default scroll rate, see [SETUP SCROLL](#)), various options are available to you –

- Press **EXIT** to abort the COMPUTE submenu.
- Press **ENTER** to transition to a state that allows you to accept, reject, or save terms,
- Wait until the text has completed scrolling and ARGO NAVIS™ will automatically enter the state that allows you to accept, reject or save terms.
- Move the **DIAL** and then manual scroll mode is entered. Turning the **DIAL** clockwise scrolls the text forward for convenient reading at your leisure while turning the **DIAL** anti-clockwise scrolls text in reverse. Pressing **EXIT** while in manual scroll mode will abort the COMPUTE submenu. Pressing **ENTER** will transition to a state that allows you to accept, reject or save terms.

For example, if your [SETUP MOUNT](#) setting is FORK EXACT ALIGN or GEM EXACT ALIGN, the scrolling information might read-

RMS=1.5' (WAS 6.7')  
ID=-78.8±12.9'  
IH=+1.0±1.0'  
MA=-11.1±5.4' (POLAR AXIS  
EAST OF SCP, MOVE WEST  
13.2') ME=+78.6±12.5'



ARGO NAVIS™

(POLAR AXIS ABOVE SCP.  
LOWER 1.31°)

In this example, **TPAS**<sup>TM</sup> has computed the 'best-fit' values of the four terms that were set to the COMPUTE state in DEFINE MODEL. It has done this based on the error residuals of the sampling data.

The RMS of the fitted data using the model defined by DEFINE MODEL was reported to be 1.5'.

The RMS of the data using the pointing kernel's current 'in use' model was reported to be 6.7'.

**TPAS**<sup>TM</sup> reported that the ID term was  $-78.8 \pm 12.9'$ .

The value after the  $\pm$  sign is a statistical measure of that term known as the Standard Deviation (also known as 'sigma'). The significance of Standard Deviation will be discussed further below.

The value of the IH term was reported as  $+1.0 \pm 1.0'$ .

ID & IH are important terms and you should always compute and use them. However, since the values of the ID & IH terms vary between sampling tests, their actual values can largely be ignored and the terms simply accepted 'on faith'.

The value of MA, which is the polar misalignment term in Azimuth, was  $-11.1 \pm 5.4'$ . **TPAS**<sup>TM</sup> then reports that this value is equivalent to the polar axis being East of the South Celestial Pole (SCP) by 13.2', this example test having been conducted in the Southern Hemisphere.

The value of ME, which is the polar misalignment in Elevation (i.e. Altitude) was  $+78.6 \pm 12.5'$ . **TPAS**<sup>TM</sup> then reports that this value is equivalent to the polar axis being above the SCP by 1.31°.

At this point, it may be tempting to adjust the mount in Az and Alt in order to improve the polar alignment. However, there are two disadvantages to doing that at this time –

- Whenever you move the mount, the pointing data becomes invalid, the data would need to be deleted, and the pointing test done again.
- By sampling more stars, additional terms may be tried in the model and the polar misalignment terms will become better defined.

Later in this section, a suggested procedure for using **TPAS**<sup>TM</sup> to improve a polar alignment will be given.

If you have been examining the reported information in manual scroll mode and would now like to accept the terms, press **ENTER**. The display might then show –

ID= $-78.8 \pm 12.9'$   
USE NOW

where the words 'USE NOW' will be flashing. By spinning the **DIAL** a detent click at a time, the bottom line of the display can be cycled as follows –

- **USE NOW** – Select this if you would like to use this term in the current 'pointing kernel'.
- **USE NOW & SAVE**– Select this if you would like to use this term in the 'pointing kernel' as well as save it into non-volatile memory (EEROM device) for use during a subsequent observing session.
- **DON'T USE**– Select this if you do not want to use the term in the current pointing kernel.

Once you have selected what you wish to do with the term, press **ENTER**. **TPAS™** will then prompt with the next term. For example –

IH=+1.0±1.0'  
USE NOW

Make your selection and press **ENTER** as before. At any time, should you decide to cancel the acceptance of the entire model, press **EXIT**. The display will then briefly show –

ALL SETTINGS  
CANCELLED...

Otherwise, when you press **ENTER** when the last term appears, the display will return to –

COMPUTE

### All about Standard Deviation

When the **COMPUTE** function reports the values of terms, it also reports a statistical measure for the term known as Standard Deviation. This is the number that appears after the  $\pm$  symbol.

You are probably familiar with the most common statistical measure of all, which is the 'average' (also known as the 'mean'). To find the mean value of a set of data, we add up the values of each data item and then divide by the total number of items.

The Standard Deviation gives some measure about the distribution or 'spread' of data about the mean. Therefore, when a data item has a small Standard Deviation, one would expect most values would be grouped around the mean.

Therefore, ideally, we want the Standard Deviation of a term to be as small as possible and the ratio of the actual value of a term to its own Standard Deviation to be as large as possible.

One analogy to help understand the significance of this is to think about a radio signal from a distant radio station. The signal is subject to interference that manifests itself in the way of noise. Think of Standard Deviation as being like noise. The Radio Engineer wants to achieve the best 'signal-to-noise-ratio' possible.

Likewise, if the values of your terms have associated large Standard Deviations, it is difficult to distinguish what is 'real' from what is noise.

As a practical guideline, except for the ID, IE, IH, MA & ME terms, never use a term in a model unless the value of the term is at least two to three times larger than its own reported Standard Deviation.

### All about Population Standard Deviation (PSD)

When there are more data samples than terms in the model, along with RMS values, the **COMPUTE** function also reports another useful statistical measure known as the Population Standard Deviation or 'PSD'. PSD is similar to RMS. However, PSD also factors-in the number of terms used in the model to attempt to provide a better estimate of the model's performance.

Sometimes when you add a new term to the model, the RMS will reduce. If the PSD reduces as well, then that is good. However, if the PSD increases, then the new term should probably be removed, as



it is likely to be doing more harm than good.

Therefore, carefully note the RMS, PSD and individual Standard Deviations of terms whenever you COMPUTE a model.

TPAS™ provides these statistical measures to assist you in determining the merit of your model.

### The SET ERROR VALUES submenu

Using the SET ERROR VALUES submenu, you can –

- Review and optionally edit the values of terms that are currently ‘in use’ by the ‘pointing kernel’.
- Review and optionally edit the values of terms that are currently saved in non-volatile memory (EEROM device) for use on subsequent sessions.

To access this submenu, spin the DIAL until you see –

SET ERROR VALUES

then press ENTER. The display might then show –

SET ERROR VALUES  
IN USE NOW

where the bottom line of the display will be flashing.

If you wish to leave the SET ERROR VALUES submenu, press EXIT.

Alternatively, by spinning the DIAL a detent ‘click’ at a time, the bottom line of the display can be alternated as follows –

- IN USE NOW
- SAVED IN NVRAM

For example, to review the terms currently in use by the pointing kernel, spin the DIAL until the display shows IN USE NOW and press ENTER. Depending upon the setting in [SETUP MOUNT](#), the display might then show –

COLLIMATION ERR  
CH=+000.0’

where the top line will be flashing. If you spin the DIAL a detent click at a time, you can cycle through the various terms available for your mount. The top line of the display shows the long name of the term and the bottom line shows the abbreviated name and its current ‘in use value’.

For example, you might spin the DIAL until the display shows –

POLAR LEFT-RIGHT  
MA=-011.1’

The bottom line shows the value of the MA term in this instance.

If you wish to leave the IN USE NOW submenu, press EXIT.

If you wish to edit the value, press ENTER. Then use the DIAL and ENTER button to alter the value a field at a time. Values are expressed as plus or minus minutes and decimal-minutes of arc.

Reviewing and editing of the SAVED IN NVRAM values is achieved in a similar way. If you have changed the value of a term SAVED IN NVRAM from what it originally was, ARGO NAVIS™ will save



the new setting into its non-volatile memory (EEROM device).

Normally it is unlikely that you would manually edit entries in this way and instead you would use the convenience of the COMPUTE submenu to put terms 'in use' and/or 'save' them for you.

When ARGO NAVIS™ is powered on, for any non-zero terms in the SAVED IN NVRAM submenu, the following will automatically take place –

- They will be copied to the IN USE NOW submenu.
- They will immediately be put in use by the 'pointing kernel'.
- They will be copied to the DEFINE MODEL submenu, where they will be available as a selection, should you decide to fix a term.

The SAVED IN NVRAM feature therefore allows you to save terms that you have found to be persistent between observing sessions. Since they are put in effect the moment you power the unit on, your initial alignment and subsequent pointing benefits from having a preliminary model in place from the start of the session.

To 're-synchronize' the model, it is recommended that you then perform a short pointing test of perhaps 4 to 8 stars.

Using DEFINE MODEL, you would set any non-persistent terms (such as any Index Error term and possibly the Polar Misalignment and Collimation Error terms) as COMPUTE and leave any persistent terms as fixed values.

If you have an equatorial mount on a permanent pier, you might require as few as 2 to 4 stars to re-synchronize the model, in this case, recomputing only the

Index Error terms (ID & IH) and possibly the Collimation Error term (CH).

### The REVIEW DATA submenu

Using the REVIEW DATA submenu, you can -

- Review pointing test samples an item at a time and examine their raw pointing error residuals.
- Review pointing test samples an item at a time and examine their current fitted pointing residuals (as determined by the model currently 'in use' by the 'pointing kernel').
- Delete any individual item.
- Delete all items.
- Examine the raw RMS for the entire pointing test data (i.e. as if all terms were zero).
- Examine the fitted RMS for the entire pointing test data (as determined by the model currently 'in use' by the 'pointing kernel').

Assuming you are in the SETUP MNT ERROR menu, spin the **DIAL** until you see-

### REVIEW DATA

then press **ENTER**. By default, **TPAS™** then shows you the last object that was sampled. For example, the display might then show –

```
CANOPUS
ITEM=4  Δ=12.0'
```

The capital Greek "Delta" symbol, Δ, denotes that that the raw pointing residual for the sampled star, CANOPUS, was 12'.

If you spin the **DIAL** anti-clockwise a detent click at a time, you can review the



ARGO NAVIS™

earlier pointing samples. For example, spinning the **DIAL** anti-clockwise one step might show -

PROCYON  
ITEM=3 Δ=3.4'

spinning the **DIAL** anti-clockwise one step more might show -

CAPELLA  
ITEM=2 Δ=57"

Note in the previous display, the residual was shown in arcseconds. Spinning the **DIAL** anti-clockwise one step more might show -

SIRIUS  
ITEM=1 Δ=30"

Spinning the **DIAL** anti-clockwise one step more would then show -

START OF DATA

When the display shows START OF DATA, if you press **ENTER**, the display will show -

START OF DATA  
DELETE ALL? NO

where the word NO will be flashing. By spinning the **DIAL**, you can alternate the flashing text between NO and YES.

To delete all the pointing data, you would select YES and press **ENTER**.

To avoid deleting the data, either press **EXIT** or select NO and press **ENTER** or **EXIT**.

You can also delete individual items. For example, spin the **DIAL** clockwise one step and the display might show -

SIRIUS  
ITEM=1 Δ=30"

If you press **ENTER**, the display would then show -

SIRIUS  
DELETE ITEM?

To delete the item, press **ENTER**. To avoid deletion of the item, press **EXIT**. If you delete an item, the item numbers automatically re-sort.

Now spin the **DIAL** clockwise until the display shows, for example -

END OF DATA  
RAW RMS=6.7' Δ

This shows the raw RMS for the sampled data. That is, the RMS if no terms were in use.

Now press **ENTER**. The display might then show -

END OF DATA  
DELTAS=RAW Δ

where the text, "RAW Δ", will be flashing.

By spinning the **DIAL** a detent 'click' at a time, the bottom line of the display can be alternated as follows -

- DELTAS=RAW Δ
- DELTAS=FITTED ∂

The ∂ symbol is the lowercase Greek letter "delta" and ARGO NAVIS™ uses it to denote a fitted pointing residual.

For example, spin the **DIAL** until the display shows -

```
END OF DATA
DELTAS=FITTED  @
```

then press **ENTER**. The display might then show –

```
END OF DATA
FIT RMS=1.5'  @
```

This shows the fitted RMS for the sampled data. That is, the RMS using the terms that are currently in use by the 'pointing kernel'. The values of these terms can be examined in the "IN USE NOW" submenu of the SET ERROR VALUES submenu.

Note in this example that the raw RMS of 6.7' dropped to a fitted RMS value of 1.5'.

To examine the fitted residuals of each object, spin the **DIAL** anti-clockwise a detent click at a time.

For example, spinning the **DIAL** anti-clockwise one step might show-

```
CANOPUS
ITEM=4  @=1.5'
```

Note that the fitted residuals of individual items should generally become smaller when compared to their raw residuals, though some may actually increase. However, **TPAS**<sup>TM</sup> will always compute the optimal value for each of the terms in the model in order to provide the best possible fit for the pointing data.

Now and then, immediately after having performed a **COMPUTE** function and putting a model in use, it is recommended you use the **REVIEW DATA** submenu to examine the fitted pointing residuals.

If any one item stands out as having a very large fitted residual compared to

other items, then you might contemplate whether the object was misidentified and therefore should be deleted.

After deleting a term, it is recommended to use the **COMPUTE** function to fit and put 'in use' a new model.

However, it is recommended you delete judiciously. Deleting perfectly valid samples, which happen to have high residuals, in order to reduce the overall RMS, contradicts the purpose of a pointing test. Specifically, the system will have less information from which to derive meaningful results for your telescope.

### Continuing the pointing test

The advantage of fitting and putting in use a model early during the pointing test is that your pointing improves and the risk of misidentifying a subsequent sample star is reduced.

Thus, having fitted an initial model, you may then wish to continue with sampling more stars.

One useful feature of using [MODE TOUR](#) to perform a sampling run is the **REJOIN LAST TOUR** selection.

For example, say you had been using [MODE TOUR](#) to perform a pointing run and then had exited from that mode in order to use the features of **SETUP MNT ERRORS**.

If you re-enter **MODE TOUR** having been on a tour, the top line of the display will prompt you with this message -

```
FIND ANY OBJECT
```

However, the word **FIND** will be flashing. By turning the **DIAL**, you can alternate the flashing value to either -

- **FIND**



ARGO NAVIS<sup>TM</sup>

or

- **REJOIN LAST TOUR**

By pressing **ENTER** when the display shows **REJOIN LAST TOUR**, you will rejoin the tour from the point you were last at. If you spin the **DIAL** one detent click clockwise, you will then be presented with the next star in the tour. For example, the display might then show -

**RIGEL  
GUIDE 5→0 7↓3**

As before, center the star using a high-power or reticle eyepiece. Then press **ENTER** to sample the star position.

For example, the display might then show, for two seconds -

**RIGEL  
ITEM=5  $\partial$ =15"**

ITEM=5 denotes that this was the fifth item sampled.

The  $\partial$  symbol denotes a fitted pointing residual. Once there are non-zero terms in the SET ERROR VALUES/IN USE NOW submenu, the 'pointing kernel' will then use those terms and the  $\partial$  symbol acts as a reminder that you have a pointing model in use.

In a similar fashion, if you have non-zero terms in the SET ERROR VALUES/IN USE NOW submenu and then perform an alignment operation, rather than the word

**WARP**

appear, the display will show the word -

**$\partial$ WARP**

Again, this acts a reminder that you have non-zero mount error terms and an associated pointing model in place.

### Re-define and re-compute a model often during a pointing test

As mentioned earlier, there is an advantage in fitting and putting a model in use early during a pointing test.

For a long pointing test, one strategy is to initially sample just a few stars that are possibly close together, for example, in the same constellation. At that point, fit and put in use an initial model. You may then find that the pointing accuracy of the telescope has improved to a sufficient extent that you can then start to sample stars further away from that starting point.

As you take more samples, take the time to return to SETUP MNT ERRORS and experiment with fitting a new model. Think of the DEFINE MODEL and COMPUTE submenus as being an experimenter's workbench. If the reported RMS and PSD do not improve when you COMPUTE a new model, simply press **EXIT**, return to the DEFINE MODEL submenu and try adding or removing terms.

Note that as you move to different parts of the sky, the RMS and PSD values may increase because some un-modelled fabrication error might be more pronounced in that region.

### Recommendations on the number and distribution of sample stars

How many stars you should sample is dependent on what type of telescope and mount you have and what your pointing goals are.



For example, to perform an initial analysis of your telescope, you should consider 10 to 30 stars.

A more in-depth analysis may require 50 to 100 stars, particularly if your model has many terms.

Depending upon your goals, you may decide to perform more than one pointing run. The value of a model is in its predictive capability. If you find that you get similar values for terms from one session to the next, your confidence in the predictive ability of the model will increase.

Telescopes mounted on permanent piers are good candidates for long pointing runs as the model is less likely to change.

Ideally, the sampled stars should be evenly distributed across the sky in Azimuth and Altitude. Keep in mind that because of the apparent rotation of the sky, choosing stars with an even distribution in RA & Dec is not the same.

When sampling stars, ARGO NAVIS™ will reject any that are not at least 10 degrees above the horizon and will also reject stars that are too close to the pole of the telescope.

### Recommendations on what terms to add and when to add them

The following provides very rough guidelines on what terms to consider adding to your model and when.

For FORK EXACT ALIGN and GEM EXACT ALIGN –

2 stars – ID, IH

4 stars – MA, ME

5 – 6 stars – NP

6 –10 stars – CH

10-30 stars - DCEC, DCES, HCEC, HCES

30-100 stars DAF, FO, TF

For FORK ROUGH ALIGN and GEM ROUGH ALIGN –

4 stars – ID

5 –6 stars – NP

6-10 stars – CH

10-30 stars DCEC, DCES

For ALTAZ/DOBSONIAN and EQ TABLE EXACT-

4 stars – IE

5 –6 stars – NP AE

6-10 stars – CA

10-30 stars ECEC, ECES

It may seem tempting to simply set all terms to COMPUTE. However, the best model is the one that provides the best possible fit with the smallest number of terms.

The following “rules” may assist in that regard –

- Except for the Index Error terms (ID, IE, IH) and the Polar Misalignment terms (MA, ME), never use a term in a model unless its value is at least two to three times larger than its reported Standard Deviation (also known as its ‘sigma’).
- When adding a term to a model, look at its own individual Standard Deviation, its effects on other terms and whether both the RMS and the Population Standard Deviation (PSD) decreased. PSD is often a better indication of whether there was a real improvement. If the RMS decreased, but not the PSD, consider revising the model by removing or trying a different term.

Now look through the telescope (or if need be, the finder) and observe where the star actually is.

The difference between where the system ‘thinks’ the star is and where it actually is will then be predominantly due to the polar misalignment of the mount.

Without moving the telescope in RA and Dec, move the mount in Az and Alt to center the star in a high-power or reticle eyepiece.

GUIDE to a second star and adjust the mount in Az and Alt if need be. Repeat if necessary.

The advantage of this approach is that it can often be quicker than a drift test and it can take into account mount fabrication errors that a drift test does not. One limiting factor will be the finite resolution of the encoders in your system.

### Using TPAS™ to assist with polar aligning a mount

If your [SETUP MOUNT](#) setting is FORK EXACT ALIGN or GEM EXACT ALIGN and you would like to align your mount more accurately, the following procedure will be helpful.

Perform a pointing sample run and fit the best possible model to the data.

Then manually edit the MA and ME terms in the SET ERROR VALUES, IN USE NOW submenu to be zero.

Then GUIDE to a star so that the bottom line of the display reads, as closely as possible to–

GUIDE 0.00 0.00



ARGO NAVIS™



## SETUP REFRACTION

### Function

SETUP REFRACTION allows you to turn refraction modelling either on or off.

Due to the phenomenon of atmospheric refraction, celestial objects close to an observer's horizon will appear to be higher in altitude than they actually are. ARGO NAVIS™ can compensate for the effects of atmospheric refraction. However, to do so, ARGO NAVIS™ must have had the time zone, date, time and location set reasonably accurately. It uses these parameters in conjunction with information it will obtain once you perform an alignment, to determine where the local horizon is. Having determined that, it then can correct for refraction.

If you have inadvertently set the time zone, date, time or location to a value that is significantly different from your circumstances and switch refraction modelling on, then this can result in large pointing errors in some regions of the sky. Therefore, you should always double-check these parameters.

If you do not plan to observe objects close to the horizon, you may decide to leave refraction modelling off. However, if you are confident you have set your time zone, date, time and location correctly, it is a good idea to turn it on to improve your pointing accuracy.

It is highly recommended to turn refraction modelling on when performing a star-pointing test as this can help refine the determination of any mount error terms. See [SETUP MNT ERRORS](#) for details.

If the star-pointing test was performed with refraction modelling on, it is highly recommended to leave it on during any subsequent use of this pointing model.

### Using SETUP REFRACTION

Enter the MODE SETUP menu then spin the **DIAL** until you see -

**SETUP REFRACTION**

then press **ENTER**. The display will indicate whether refraction modelling is currently ON or OFF. For example -

**REFRACTION=OFF**

indicates that refraction modelling is currently off, which is the factory default. Spinning the **DIAL** a detent 'click' at a time toggles the state to be either OFF or ON.

When you have set the desired state, press **EXIT** or **ENTER**. If you have changed the state from what it originally was, ARGO NAVIS™ will save the new setting into its memory (EEROM device).

Note that as a special feature, if your current latitude is set at 00:00:00 and your longitude is set at 000:00:00, which are the factory default values for [SETUP LOCATION](#), then if you attempt to turn refraction modelling on, ARGO NAVIS™ will warn you with the message -

**REFRACTION=ON  
CHECK LOCATION**

### See also

[MODE SETUP](#)



ARGO NAVIS™



[SETUP DATE/TIME](#)

[SETUP LOCATION](#)

[Factors that affect pointing accuracy](#)



ARGO NAVIS™

## SETUP SCRATCH

### Function

SETUP SCRATCH allows you to enter the name and the Right Ascension (RA) and Declination (Dec) of up to two scratch objects, which you can then GUIDE to from the SCRATCH OBJECTS catalog of [MODE CATALOG](#).

If you wish to create more than two user-defined objects at any one time, it is recommended that you consider the downloadable [USER CATALOG](#) feature.

### Using SETUP SCRATCH

Enter the MODE SETUP menu then spin the **DIAL** until you see -

SETUP SCRATCH

then press **ENTER**, where you will then see an object name and an RA/Dec co-ordinate pair such as this -

SCRATCH 1  
00:00:00 +00°00'

where the top line of the display will be flashing. If you turn the **DIAL** you can alternate between the two scratch objects.

If you would like to retain the existing name, simply press **ENTER** multiple times until the blinking cursor steps to the start of the RA/Dec co-ordinates in the bottom line of the display.

If you wish to change the name of the object to act as a mnemonic, use the **DIAL** and the **ENTER** button to edit the name one character at a time. For example, let us edit the name of the

'SCRATCH 1' object, which is the factory default name, to 'NOVA'.

Select the object you wish to edit, in this case, SCRATCH 1, by turning the **DIAL**.

Now press the **ENTER** button. You have now entered object name edit mode.

The 'S' character will be flashing indicating that the cursor is at that location. Turn the **DIAL** anti-clockwise until the letter 'N' appears, then press **ENTER** to advance to the next letter, which is a 'C'. Turn the **DIAL** in either direction to make it an 'O', press **ENTER**, and so on until you have spelt out the word 'NOVA'.

Continue to erase the rest of the characters in the old SCRATCH 1 name by turning them into SPACES. The SPACE character is found just after the letter 'Z' if you are turning the **DIAL** clockwise. When you have entered two successive SPACE characters, ARGO NAVIS™ automatically leaves object name edit mode and enters RA/Dec edit mode. For example, the display might show this

NOVA  
00:00:00 +00°00'

where the first 'O' in the bottom line will be flashing.

Now use the **DIAL** and the **ENTER** button to edit the RA/Dec of the object.

RA is displayed in terms of hours:minutes:seconds or hours:minutes decimal minutes either Change the second colon character ':' to a decimal point '.' if the RA available to you is in hours.minutes.decimal minutes format.



ARGO NAVIS™

Dec is displayed in terms of +/- degrees and minutes. Change the '+' or '-' sign and edit the remaining fields as appropriate.

When you have edited the last Dec field, press **ENTER**.

The unit will then return to the mode whereby the top line of the display is flashing. If you wish to edit the second scratch object, turn the **DIAL** to select it and edit as in the previous example.

When you have completed editing your scratch objects, press **EXIT** or **ENTER**. If you have changed the names or co-ordinates of either object from what they originally were, **ARGO NAVIS™** will save these new values into its memory (EEROM device).

To **GUIDE** to a scratch object, press exit and turn the **DIAL** until you see -

**MODE CATALOG**

then press **ENTER**. If need be, spin the **DIAL** until you see -

**SCRATCH OBJECTS**

then press **ENTER**.

Use the *Intelligent Editing System™* to enter the name of the scratch object of interest and then press **ENTER**.

The display might then show -

**NOVA**  
**GUIDE 125→ 7↓3**

Move the telescope in both axes until the display reads -

**NOVA**  
**GUIDE 0.0 0.0**

Pressing **ENTER** again will display the following scrolling information about the object. For example -

**NOVA SCRATCH OBJECT IN HYDRA**  
**RA=10:22:22" DEC=-20°01'00"**  
**J2000.0 ABOVE HORIZON HB=C67**

While the text is scrolling, you can enter manual scroll mode by moving the **DIAL**.

**See also**

[MODE CATALOG](#)



## SETUP SCROLL

### Function

SETUP SCROLL allows you set the automatic scroll rate for text.

ARGO NAVIS™ automatically scrolls any text message that is longer than the width of the display. For example, object descriptions and some warning messages automatically scroll to make them possible to read.

However, you should remember that you can always manually scroll a long message at any time by simply moving the **DIAL**.

The legibility of scrolling text can be influenced by a number of factors –

- The scroll rate.
- The LCD brightness. Brighter displays make for easier reading but can have a greater impact upon night vision. (See [SETUP BRIGHTNESS](#)).
- The LCD contrast. This should be set to the optimum value. (See [SETUP CONTRAST](#)).
- The temperature of the LCD. Cold displays (particularly below 0°C or 32°F) have slower responses. (See [SETUP LCD HEATER](#)).
- Human perception

### Using SETUP SCROLL

Enter the MODE SETUP menu then spin the **DIAL** until you see -

SETUP SCROLL

then press **ENTER**. The display might show something like this –

SCROLL RATE=3

This indicates the current scroll rate is 3, which is the factory default setting. Spin the **DIAL** in either direction to select a scroll rate value. The scroll rate settings range from 0 (very slow) to 9 (very fast).

When you have set the desired value to suit your requirements, press **EXIT** or **ENTER**. If you have changed the value from what it originally was, the word **SAVING ...** will appear briefly on the bottom line as ARGO NAVIS™ stores the new setting into its memory (EEROM device). You might then like to check the rate of scrolling by looking at an object description in MODE CATALOG.

### See also

[MODE CATALOG](#)

[MODE IDENTIFY](#)

[MODE TOUR](#)

[MODE SETUP](#)

[SETUP BRIGHTNESS](#)

[SETUP CONTRAST](#)

[SETUP LCD HEATER](#)



## SETUP SERIAL

### Function

ARGO NAVIS™ has two independent RS-232 serial communications ports, named **SERIAL1** and **SERIAL2**. The serial ports allow you to connect your ARGO NAVIS™ to a PC or Macintosh™ computer.

SETUP SERIAL allows you to set the Baud rate (communications speed) and “startup command” for both of them.

To understand what is meant by “startup command”, some background explanation is required. Each serial port runs its own copy of a powerful command interpreter program called the “[shell](#)”. The “shell” accepts the names of programs and other command parameters (called arguments) on a command line and then calls upon the ARGO NAVIS™ multi-tasking operating system to run them. The various commands that the “shell” can run are listed in the [Programmer’s reference](#). As a special feature of the “shell”, some of these commands can be made to execute automatically when the ARGO NAVIS™ is first powered on. These are known as “startup commands”.

One startup command is called “[navis](#)”. You would set your startup command as “navis” if you want to use that port for user catalog, asteroid, satellite or comet orbital element downloads from the supplied ARGONAUT™ utility. You would also set it to “navis” for use with “ARGO NAVIS™ aware” programs such as Star Atlas:PRO™ that can provide a tracking cursor display against a map of the sky as

you move your scope or Astroplanner™ that allows you to download observing lists into the ARGO NAVIS™ user catalog.

Another one of these commands is called “[meade](#)” because when it executes, it emulates a sub-set of the Meade LX-200™ protocol commands. This enables you to interface your ARGO NAVIS™ to a PC running a program such as TheSky™ or SkyMap Pro™, which you would configure as if it were communicating to a Meade telescope. This would also enable you to have a tracking cursor display against a map of the sky on your PC screen.

When used in conjunction with the appropriate startup command, ARGO NAVIS™ can be interfaced to every known planetarium program.

Planetarium programs that support the ASCOM Initiative for Windows are fully supported. In this case, you should configure your ASCOM driver as if it were communicating to a Meade LX-200™.

Planetarium programs running on the Linux™ operating system are fully supported by the INDI library.

ARGO NAVIS™ provides support for the [ServoCAT™ GOTO controller](#) via the “[servocat](#)” startup command.

ARGO NAVIS™ provides support for the SiTech™ GOTO controller via the “[sitech](#)” startup command.

ARGO NAVIS™ provides support for the SkyTracker™ GOTO controller via the “[skycomm](#)” startup command.



ARGO NAVIS™ can be ‘piggybacked’ to a device that responds to Tangent™ protocol commands via the [pbt](#) command. Such devices include the Orion IntelliScope™ controller, NGC-MAX™, Celestron Advanced Astromaster™, the Lumicom Sky Vector™ and the Software Bisque BBox™. To interface these devices to ARGO NAVIS™, a special serial cable is required that acts as a ‘null-modem’ device. Contact [Wildcard Innovations](#) for details on how to purchase this cable.

### Using SETUP SERIAL

Enter the MODE SETUP menu then spin the **DIAL** until you see -

SETUP SERIAL

then press **ENTER**. For example, the display might then show something like this -

SERIAL1 BAUD

where the ‘1’ will be flashing. Spinning the **DIAL** a detent ‘click’ at a time toggles the serial port selection to be either ‘1’ or ‘2’. When you have selected the appropriate serial port, press **ENTER**. In this example, the word “BAUD” will then start flashing. Spinning the **DIAL** a detent click at a time toggles this selection to be either “BAUD” or “STARTUP”. To change or view the current Baud rate, select “BAUD” and then press **ENTER**. For example, the display might then show something like this -

SERIAL1 BAUD=  
38400

In this case the **SERIAL1** port communications rate is currently set at 38400 Baud. This is the factory default. By spinning the **DIAL** a detent ‘click’ at a time, the Baud rate selection can be changed. The possible Baud rates are -

- 300
- 600
- 1200
- 2400
- 4800
- 9600
- 19200
- 38400
- 57600

You should ensure that the Baud rate you select matches the Baud rate selection of your PC application. For example, the ARGONAUT™ utility has a default Baud rate of 38400. However, it can be changed. ARGO NAVIS™ also ignores the Baud rate setting you have made for loading firmware when it is in BOOT LOADER mode. In this mode, the Baud rate is fixed at 38400. For downloading firmware in BOOT LOADER mode, ARGONAUT™ should also be set at 38400 Baud. Only the **SERIAL1** port can be used in BOOT LOADER mode.

Some programs, such as Sky Safari™ and SkyMap Pro™ when configured to communicate with a Meade telescope, expect the Baud rate to be fixed at 9600.

ARGO NAVIS™ always uses 8 data bits, 1 stop bit with no parity for data communications.

Continuing with the example, once you have selected the desired Baud for this port, press either **EXIT** or **ENTER**. If you





have changed the value from what it originally was, the word **SAVING ...** will appear briefly on the bottom line as **ARGO NAVIS™** sets the serial port to this speed and stores the new setting into its memory (EEROM device). The display should now once again show –

**SERIAL1 BAUD**

where the word “**BAUD**” is flashing. Spin the **DIAL** until the display shows –

**SERIAL1 STARTUP**

then press **ENTER**. The display might then show –

**SERIAL1 STARTUP=**  
**navis**

This is the factory default. By spinning the **DIAL** a detent ‘click’ at a time, the startup command selection can be changed. The possible choices are –

- **meade**
- **navis**
- **pbt**
- **servocat**
- **sitech**
- **skycomm**
- **tangent**

See the [Programmer's reference](#) for an explanation of these commands.

Once you have selected the desired startup command for this port, press either **EXIT** or **ENTER**. If you have changed the value from what it originally was, the word **SAVING ...** will appear briefly on the bottom line as **ARGO**

**NAVIS™** stores the new setting into its memory (EEROM device). **Keep in mind that the chosen startup command will not execute until next time you power on your ARGO NAVIS™.**

Pressing **EXIT** again will cause the display to show –

**SERIAL1 STARTUP**

where the ‘**1**’ will be flashing. By spinning the **DIAL** until it shows ‘**2**’ and then pressing **ENTER**, it is then possible to edit the Baud rate and startup command for **SERIAL2** as was done for **SERIAL1**. Alternatively, the **EXIT** button could be pressed and the unit will return to the **SETUP** menu level. Pressing **EXIT** once more will return it to the main **MODE** menu level.

Of course, it is possible to perform the above steps in any order, editing only the required parameters for the required ports.

### Interfacing via a USB port

If your PC/Mac does not have a RS-232 serial port but is equipped with a USB port, Wildcard Innovations have available a USB to RS-232 Serial Port Adaptor ([Wildcard Innovations](#) Part No. pn-usb) which works in conjunction with the optional RS-232 serial cable (pn-ser-cbl).

### Interfacing via WiFi or Bluetooth

The **ARGO NAVIS™** RS-232 serial cable (Part No. pn-ser-cbl) can be used in conjunction with third party Wifi or Bluetooth adapters.



**ARGO NAVIS™**

### Interfacing to a *ServoCAT*<sup>™</sup> GOTO controller

ARGO NAVIS<sup>™</sup> fully supports the *ServoCAT*<sup>™</sup> GOTO system. In this case, the startup command on the appropriate serial port should be set to “servocat” and the Baud rate on the same serial port should be set to 19200. Note that the cable used to interface the ARGO NAVIS<sup>™</sup> to the *ServoCAT*<sup>™</sup> is a different cable to that which is used to interface to a PC. Be sure to identify the correct cable when interfacing the two units. See the section “[Using ARGO NAVIS with the \*ServoCAT\* Track/GOTO controller](#)” for further details.

### See also

[MODE SETUP](#)

[SETUP LOADCAT](#)

[Using ARGO NAVIS with the \*ServoCAT\* Track/GOTO controller](#)

[Programmer's reference](#) – shell commands



ARGO NAVIS<sup>™</sup>

## ARGONAUT software utility Version 2.0

### ARGONAUT™ Version 2.0 introduction

The supplied ARGONAUT™ Version 2.0 software utility is suitable to run on the following operating systems -

- Windows 2000™
- Windows XP™
- Windows Vista™
- Windows 7™
- Windows 8™ & Windows 8.1™

If you have a newer version of Windows™ than the above, then ARGONAUT™ may well run. However, as at the time of writing, it has only been tested on the above versions. Utilities of similar functionality are [also provided for the Linux™](#) operating system and for the [Apple Mac OS X™](#) operating system.

This section describes the installation and operation of ARGONAUT™ on the Windows™ platform.

### What does ARGONAUT™ do?

ARGONAUT™ is communications software that can transfer data between your PC and the ARGO NAVIS™. It transfers data via an [RS-232](#) serial port on each device. The types of data that can be transferred are –

- [Asteroid orbital element files.](#)
- [Comet orbital element files.](#)
- [Satellite orbital element files.](#)
- [User catalog files.](#)
- [ARGO NAVIS™ firmware and catalog upgrades.](#)
- [Setups saving & restore.](#)
- [Setting of unit's date and time.](#)
- [Software Clock scaling.](#)

### What else do I need besides ARGONAUT™?

In order to use ARGONAUT™, you will also need the following –



ARGO NAVIS™

- A PC with an [RS-232](#) serial COM port capability. Some PC's have an in-built 9-way male D-connector that provides serial COM port communications. Note that USB ports are not RS-232 serial COM ports. However, if you do not have a serial COM port or if you would like to install an additional serial COM port on your PC, then it is recommended that you use a USB to Serial Port Adapter. We recommend the Keyspan USA-19HS. These can be purchased from [Wildcard Innovations](#) (Part number pn-usb). Alternatively, Serial Cards, which plug into the PCIe or PCI bus of your desktop computer, are readily available from a wide-range of suppliers. A quick Google search will reveal many that can be purchased online.
- The optional ARGONAUT™ serial cable ([Wildcard Innovations](#) part number pn-ser-cbl.)
- If you want to [retrieve](#) the latest asteroid, comet or satellite orbital elements or obtain the latest firmware and catalog upgrades, you will also need a connection to the Internet. You will use your web browser to retrieve these source files from the net. You will then use ARGONAUT™ to transfer them from your PC to ARGONAUT™.

### Installing ARGONAUT™

You can install ARGONAUT™ from the supplied CD-ROM or download it from [Wildcard Innovations](#). If installing from the CD-ROM use the Windows Explorer to navigate to the “software” folder and then to the “windows” folder. Double click on the **Argonaut\_2\_0\_Setup** icon



On some current versions of Windows, the following User Account Warning will appear –

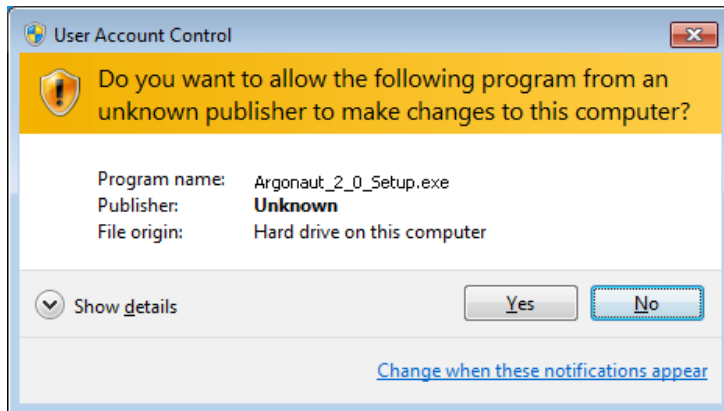

The publisher, though listed as Unknown, is Wildcard Innovations Pty Ltd and it is safe to press Yes.

The Select Setup Language dialog box will appear -.

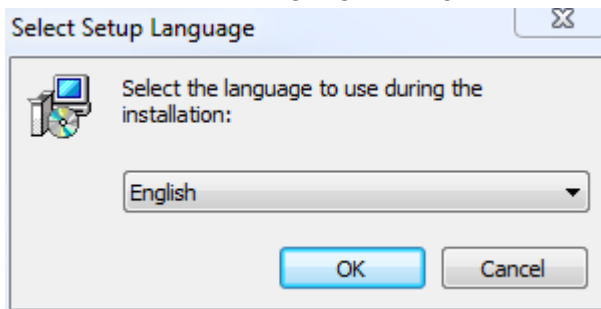

Select your language. Note that the ARGONAUT™ interface itself is only available in English. Press OK.



The following Welcome dialog box will appear –

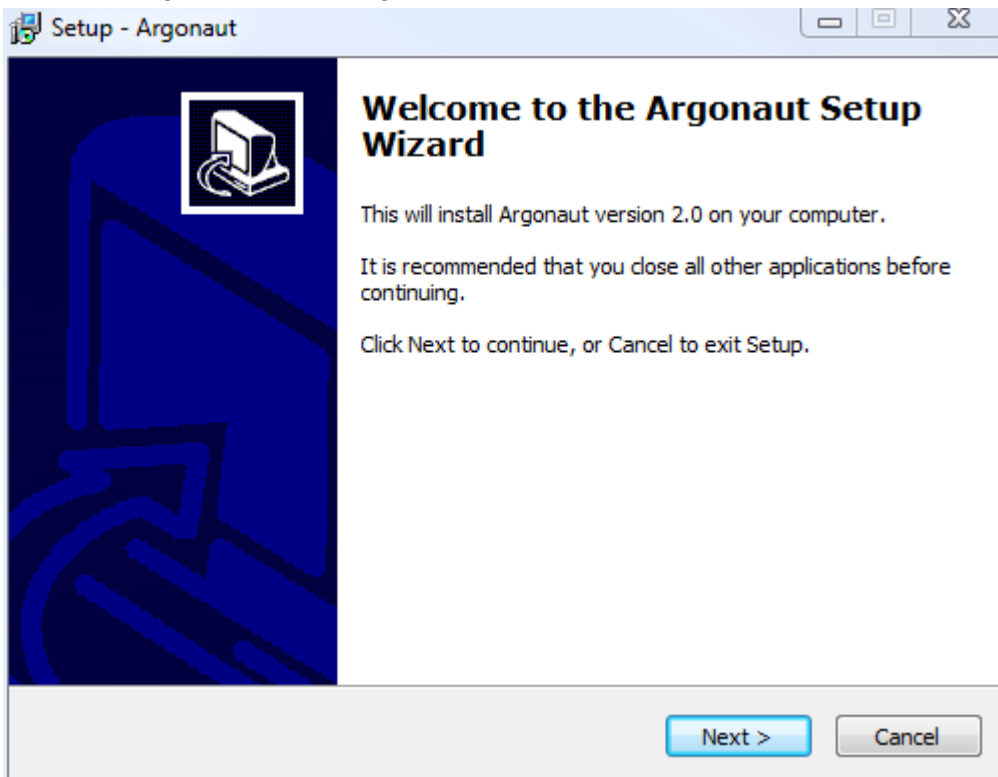

Press Next >





The Select Destination Directory dialog box will appear –

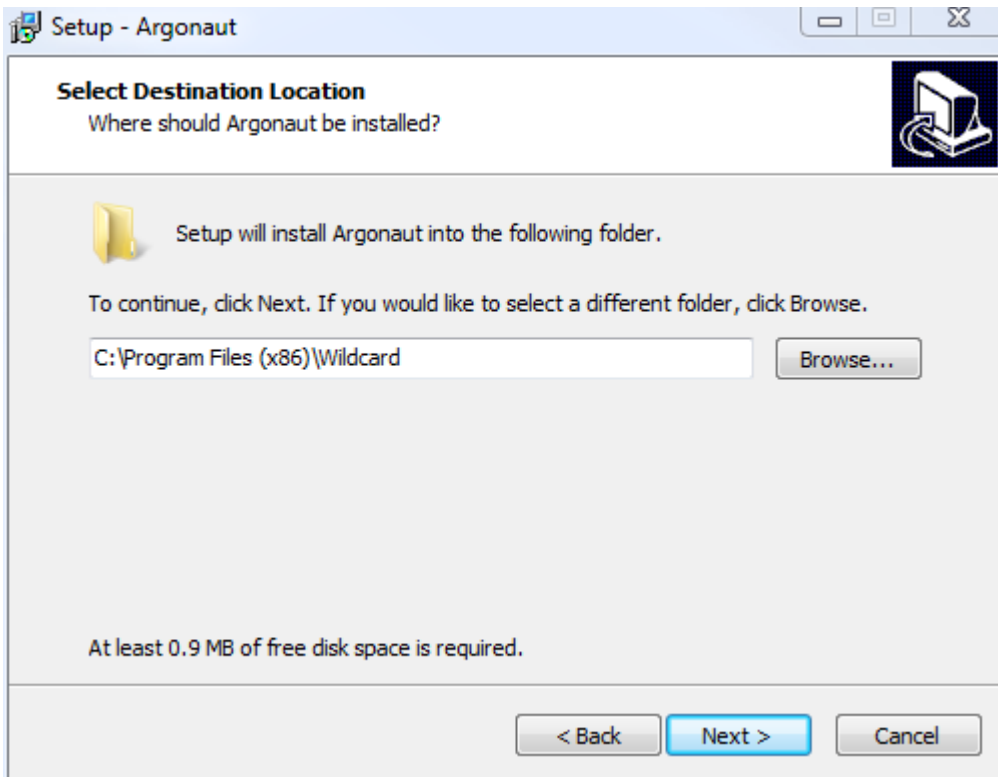

Press Next >

The Select Start Menu Folder dialog box will appear –

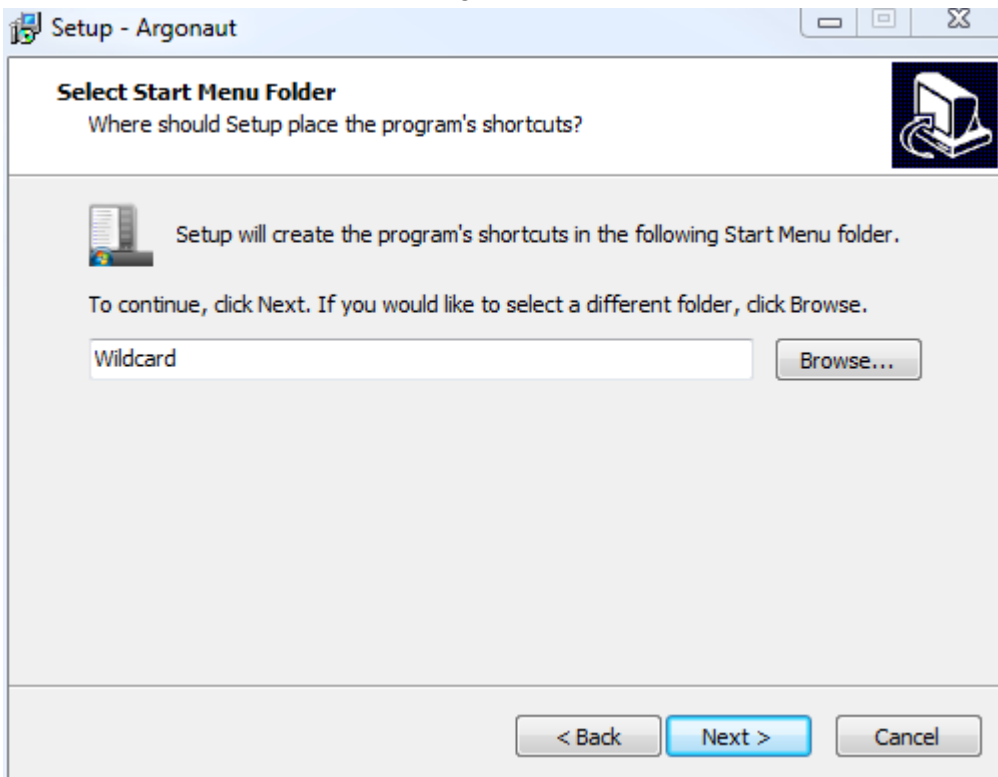

Select an appropriate Start Menu folder underneath which ARGONAUT™ will appear or simply leave the default of Wildcard and then press Next >

The Select Additional Tasks dialog box will appear -

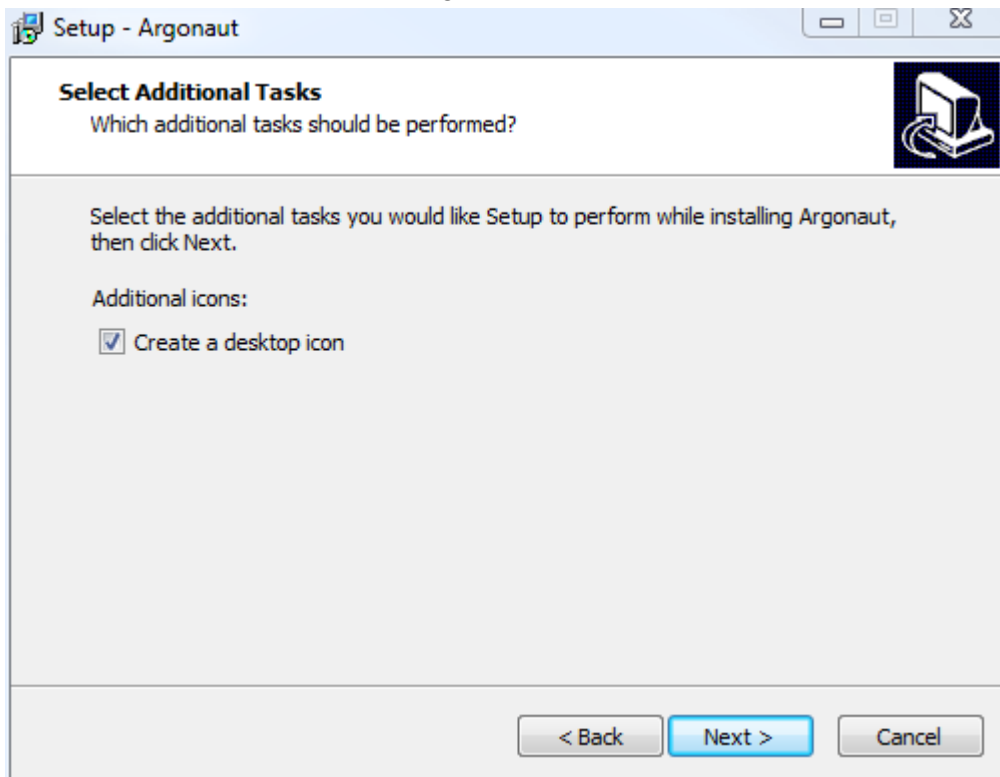

Check "Create a desktop icon" if you would like one. Press Next >

The Ready to Install dialog box will appear -

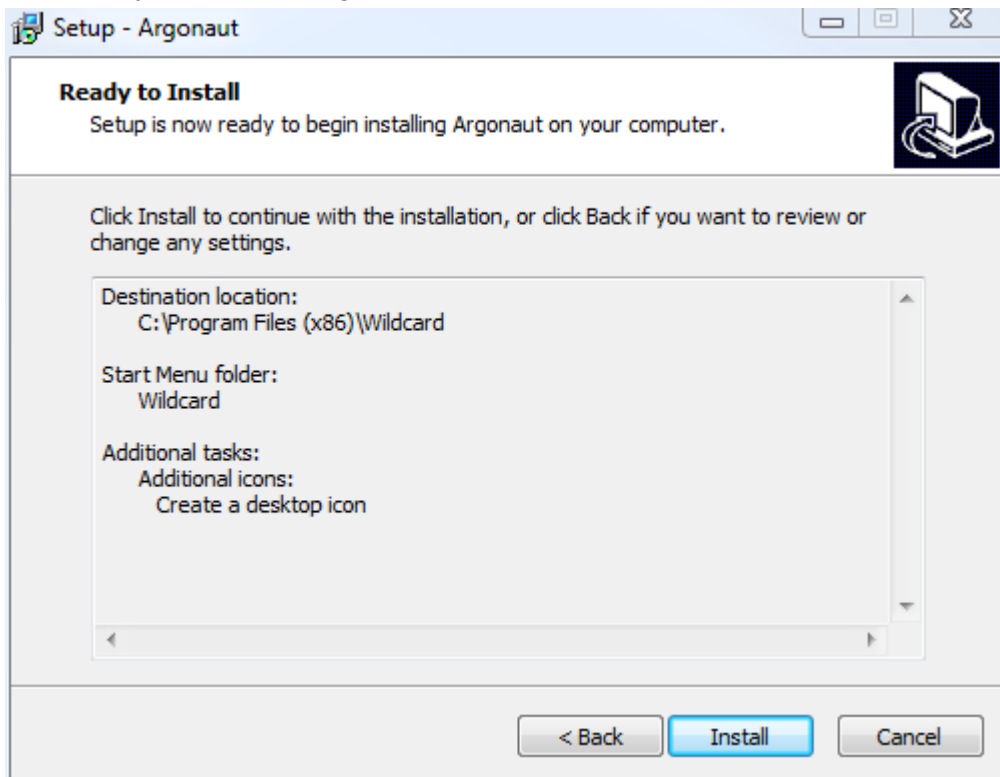

Press Install.

The Completing dialog box will appear -

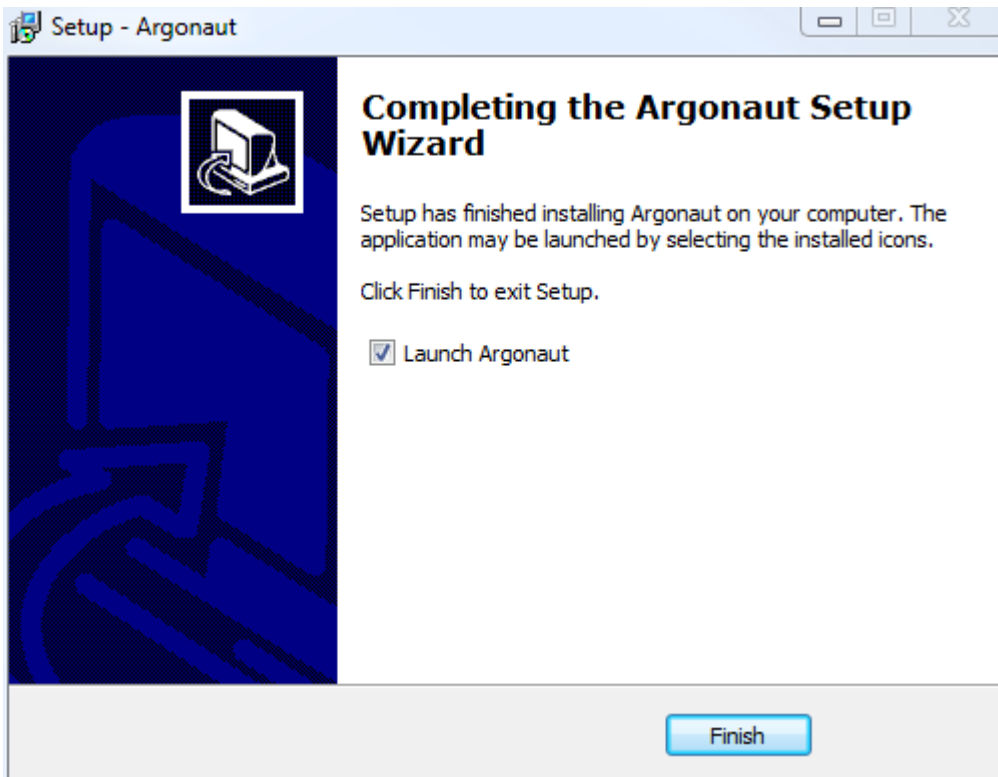

ARGONAUT™ will then be installed on your system. Press Finish to exit the Setup and to launch ARGONAUT™.

## Launching ARGONAUT™

To start the program, go to the Start icon at the lower left hand side of your Desktop. Press Start->Programs->Wildcard->Argonaut  
ARGONAUT™ should then start running –

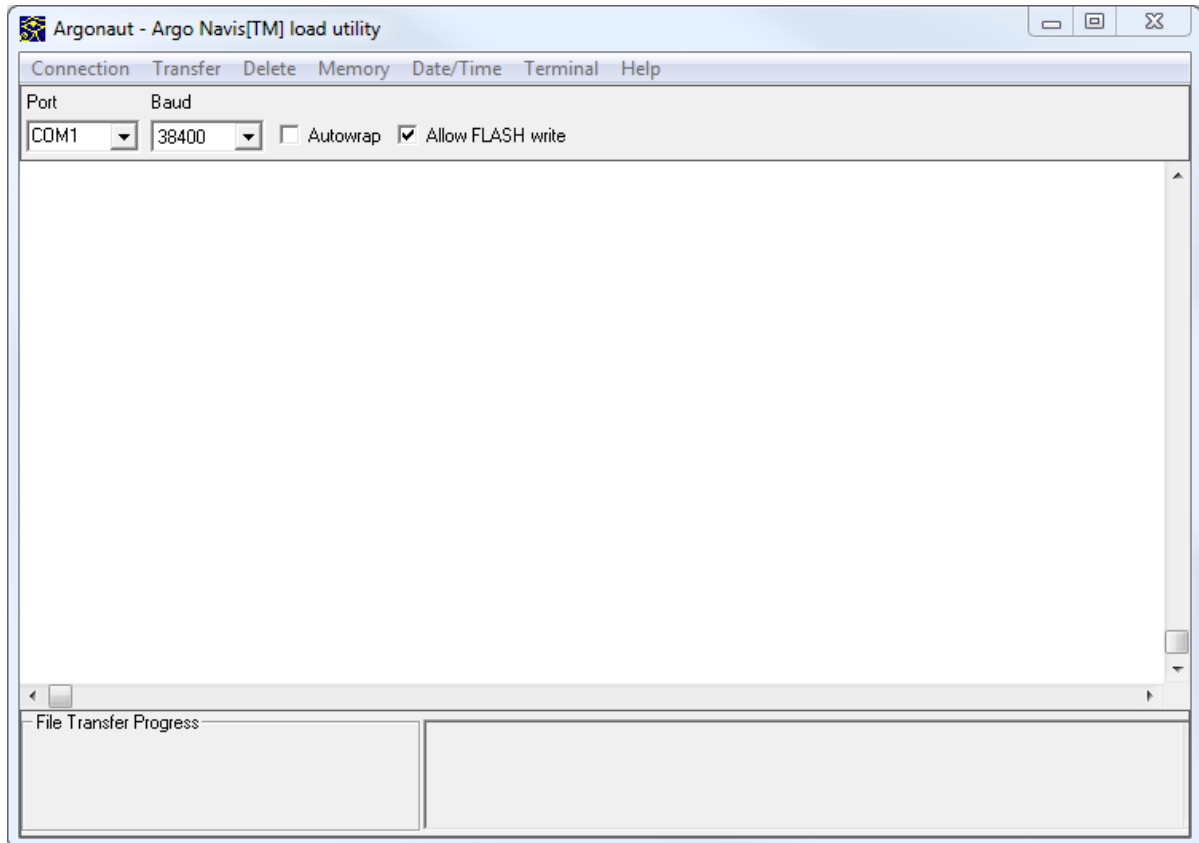

## Establishing communication

Connect the optional serial cable from your PC to ARGO NAVIS™. If your PC has an RS-232 COM port you can do this directly.

If your PC does not have an RS-232 COM port, use the optional serial cable in conjunction with a USB Serial Adapter. Wildcard Innovations recommend and stock the Keyspan USA-19HS USB Serial Adapter. Install the device driver that came with your adapter if you have not done so already and then and only then, plug in the adapter.



If you want to upgrade firmware, then you must use **SERIAL1** on the ARGO NAVIS™. The ports are clearly marked on the top of the unit. (See [Figure 2](#)).

For performing any operation, except upgrading firmware, use the following procedure. For upgrading firmware you will need to also read the section [Transferring firmware files](#).

The [Baud](#) rate selection of ARGO NAVIS™ and ARGONAUT™ need to match. Wildcard Innovations recommends that you set both Baud rates to 38400. This is the default Baud rate for ARGONAUT™.

To set your Baud rate on ARGO NAVIS™, do the following. Power on your unit. Go to [MODE SETUP](#), then [SETUP SERIAL](#) then press **ENTER**. Spin the **DIAL** to match the serial port number that is accommodating the serial cable then press **ENTER**. Spin the **DIAL** until you see the **BAUD** selection, then press **ENTER**. Now spin the **DIAL** and select the Baud rate (**38400** recommended) then press **EXIT**. Now spin the **DIAL** one click and you will see the **STARTUP** selection. Press **ENTER**. Spin the **DIAL** until you see **navis**, then press **EXIT**. Power off your ARGO NAVIS™ then power it back on.

You need to determine the correct COM Port selection on ARGONAUT™. One way to determine this is to open the Device Manager from the Windows Control Panel and expand the Ports (COM & LPT) entry -

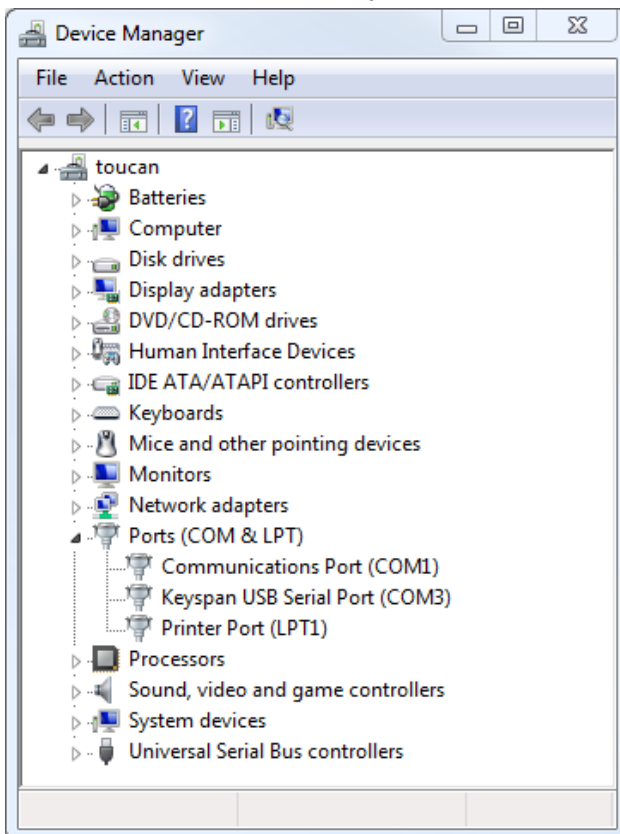

ARGO NAVIS™



You can see in the previous screenshot that the computer in this example has two COM ports. COM1 is an in-built RS-232 COM port. COM3 is a Keyspan USB Serial Adapter.

ARGONAUT™ allows you to select a COM port in the range 1 thru 4. If Windows has assigned your USB Serial Adapter to a port greater than 4, you can use the Device Manager dialog to re-assign it.

For example, right-click on the Keyspan USB Serial Port (COM3) item and select Properties from the pulldown menu. The following dialog will open –

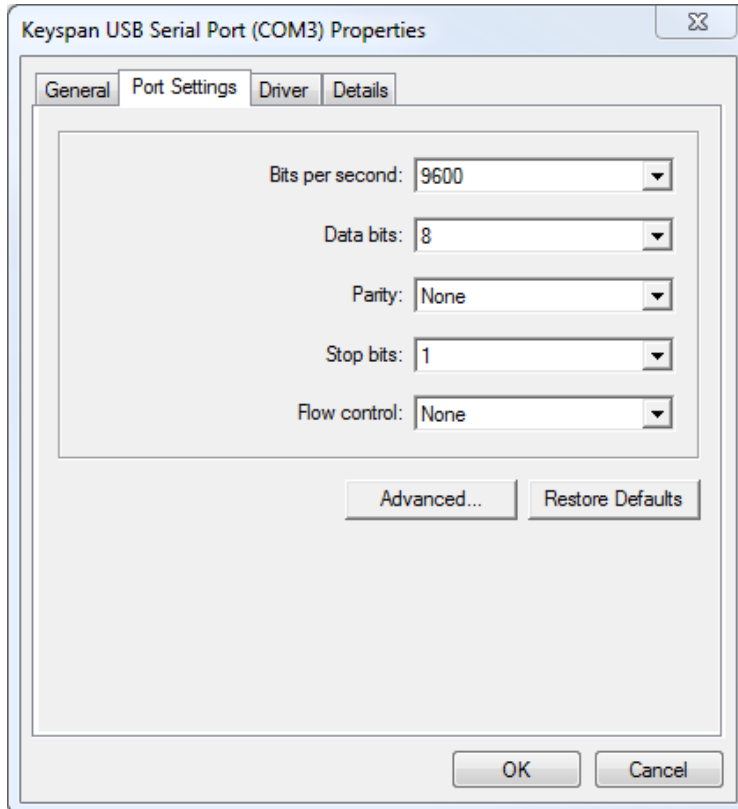

Select the Port Settings tab and click on “Advanced...”.

The following dialog will open –

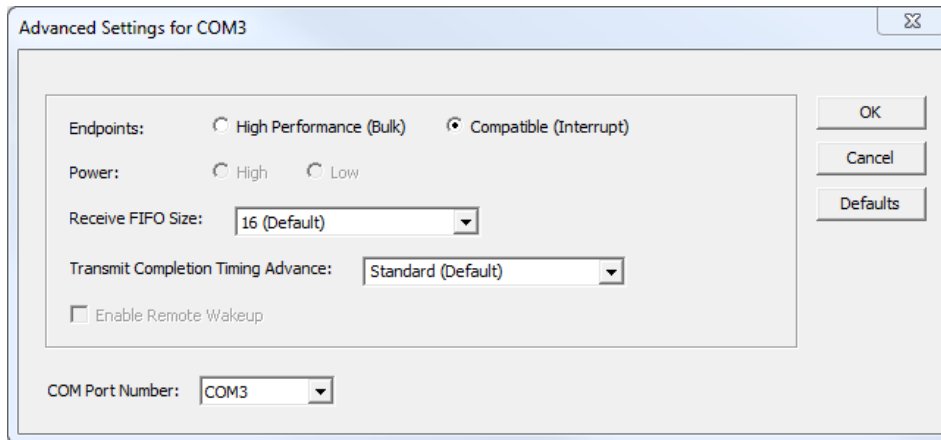

Use the “COM Port Number:” pulldown to change the assignment to be in the range of 1 thru 4.

Alternatively if you are using the Keyspan USA-19HS USB to Serial Adapter, under the “Keyspan USB Serial Adapter” folder in the Window’s Start Menu you can invoke a utility called the “Keyspan Serial Assistant”. Within the “Port Mapping” tab, use the “COM port mapping” pulldown to make the assignment.

Use the ARGONAUT™ pull down Port menu to select your COM port like this –

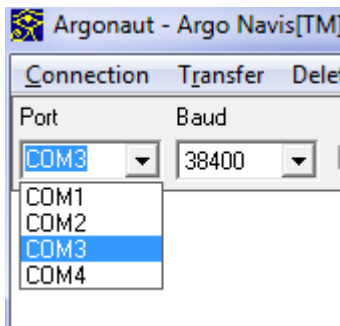

Ensure that the ARGONAUT™ Baud rate selection is the same as that on the ARGO NAVIS™.



Then attempt to Connect to the PC COM port using the Connection pull down menu –

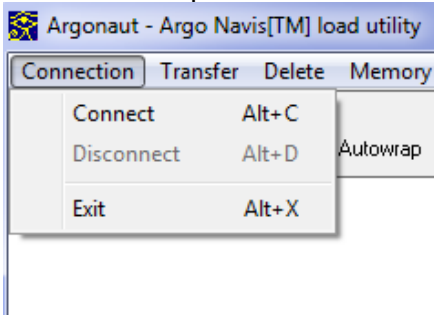

To check whether your PC can communicate with ARGO NAVIS™, try putting your mouse cursor into the large white Terminal window (see figure below for location) and pressing the Enter key on your computer’s keyboard a couple of times.

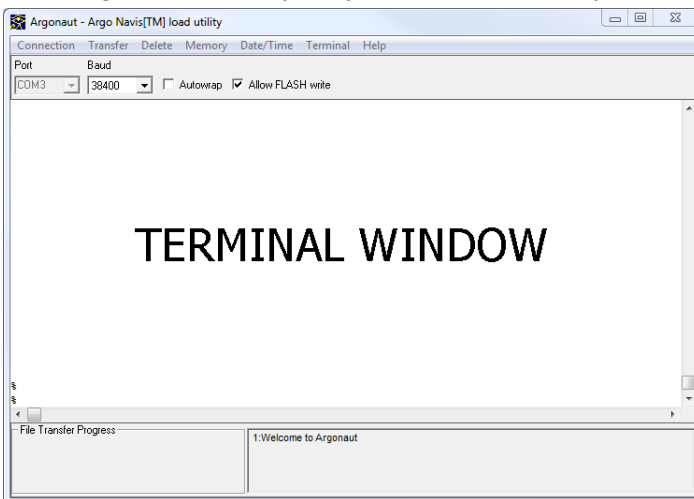

ARGO NAVIS™ should respond with a ‘%’ character prompt if communications have been established -

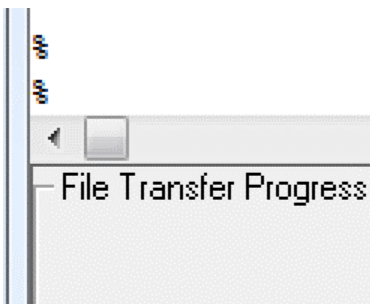

If you do not get a ‘%’ prompt, or Windows™ displays an error dialog such as this –



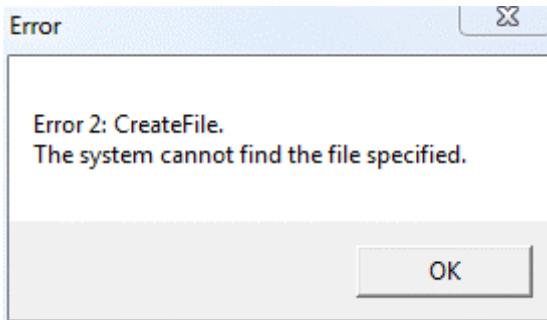

then it indicates you must have made an invalid COM port selection or that you already have another ARGONAUT™ session running that is connected to the same COM port.

It is important to appreciate that the appearance of a blinking cursor in the Terminal Window does not necessarily indicate that the correct COM port was used. If you did not receive the percent prompt or if you received an error, do the following. Use the Disconnect selection in the Connection pull-down. Verify the correct COM port using the Device Manager dialog described earlier. Change the COM port selection. Then use the Connect selection in the Connection pull-down. If you are still unable to establish communications then check that the [serial port](#) connections at each end are correct and verify the ARGO NAVIS™ [serial setup](#) once again.

## Where to obtain Asteroid, Comet or Satellite Orbital Element Files

ARGO NAVIS™ uses the same orbital element formats as TheSky™ software package.

You can obtain the orbital elements of Asteroids (Minor Planets) and of Comets from the IAU Minor Planet Center web site –

<http://www.minorplanetcenter.net/iau/Ephemerides/Soft06.html>

ARGO NAVIS™ currently allows you to download a maximum of 50 Asteroid orbital elements and 10 Comet orbital elements at any one time. If need be, use a plain text editor, such as Notepad™ to edit your downloaded orbital element files so as to choose the objects you would like to load. Do not use an editor such as Word™ or WordPad™ as they might embed hidden text formatting characters that will corrupt your file. Save your files with a '.txt' suffix.

Later, when you load an Asteroid file into ARGO NAVIS™, an ASTEROIDS catalog will appear in the [MODE CATALOG](#) menu. Similarly when you load a Comet file, a COMETS catalog will appear.

When comets are first discovered there may not have been sufficient observations over a long enough period of time for the Minor Planet Center to accurately determine their orbital elements. Therefore you should update your comet orbital elements on a very



regular basis, particularly if you plan on observing a recently discovered comet. You should also ensure that the [current date and time](#) is correctly [set](#) on ARGO NAVIS™, otherwise it will calculate the positions of the Asteroids and Comets for the time it is set at. Furthermore, due to the iterative method used to compute the positions, an incorrectly set date or a very old orbital element set may prevent ARGO NAVIS™ converging on a solution. In this case it will set the [J2000.0](#) position of the object to RA 00:00:00 Dec 00:00:00. It will also provide a warning message when you look at the object's description. In this circumstance, you should [delete](#) the old catalog and load a newer orbital element set.

Orbital elements for Satellites (known as Two Line Elements - TLE's – even though they are three lines long) are available from a variety of places on the Internet including -

<http://celestrak.com/NORAD/elements/>

ARGO NAVIS™ currently allows you to download a maximum of 25 satellite orbital elements at any one time. Use a text editor such as Notepad™ to edit your downloaded orbital element files. Do not use an editor such as Word™ or WordPad™. Save your files with a '.txt' suffix.

When you later load a Satellite file into ARGO NAVIS™, a SATELLITES catalog will appear in the MODE CATALOG menu.

Since the orbits of many satellites decay and alter quite quickly, you should always use a recent set of orbital elements if you plan to observe satellites. As a rule of thumb, don't use satellite orbital elements that are more than about a week old. Make absolutely sure that your current [date, time](#) and [location](#) are accurately set. ARGO NAVIS™ may devote unnecessary computational time trying to calculate a position for a satellite when the date has been incorrectly set or when the orbital elements become old. [Delete](#) or [update](#) old Satellite catalogs on a regular basis.

Though ARGO NAVIS™ allows for the names of objects to be up to 32 characters long, those names must be unique within the first 16 characters. Edit the names if need be to create unique entries.

ARGO NAVIS™ will flag missing or incorrectly formatted fields as errors and the transfer will be aborted if they are encountered.

ARGO NAVIS™ organizes its loadable catalog area as a pool of memory that is shared between Asteroid, Comet, Satellite and User catalog entries. If the [memory pool is full](#), then you may need to [delete a catalog](#) before loading a new one.

### **How to create your own User catalog files**

ARGO NAVIS™ has a powerful feature whereby you can create your own User catalog files. Use a plain text editor such as NotePad™. Do not use an editor such as Word™ or



WordPad™ as they will embed hidden text formatting characters that will corrupt your file. Save your file with a '.txt' suffix.

Typically you can load up to 1100 objects depending upon how much [free space](#) is available in your loadable catalog memory pool and how long the names and descriptions of objects are.

Later, when you load a User catalog file into ARGO NAVIS™, a USER catalog will appear in the [MODE CATALOG](#) menu. You can even identify or tour your own User objects in [MODE IDENTIFY](#) and [MODE TOUR](#).

Here is an example of a small User Catalog file below containing some fictitious objects –

```
BEBOP GALAXY|12:34:56|+12:34|GALAXY|14.2|COOL OBJECT, FIRST SHOWN TO ME BY CHARLIE
JAZZ GALAXY|00:01:23|-52:09|GALAXY|15.2|SIZE=10', BRIGHT CORE, MORPH=Sa, OBSERVED IN THE 20"
SAX NEBULA|13:45.2|-12.33|PLANETARY|12.1|MAG 15 STAR AT CENTER. USE FILTER.
THE SPOT|18:12:00|-75:00|DARK NEBULA|ANY|SIZE=2.0'x3.0' VERY OPAQUE
BIG NOVA|23:34:14|+75:34|VARIABLE|-6|
THELONIOUS TRIPLE|03:09:12|+12:23:45|TRIPLE STAR|10.2|TRIANGLE OF RED, WHITE , BLUE STARS
```

The formatting rules for User catalog files are as follows –

There can be only one entry per line and the entry can only be one line long. A line entry can be no longer than a total of 254 characters. The various fields of the entry are separated by vertical bar characters '|'. White space characters (Spaces and Tabs) are allowed before and after vertical bars. Empty (blank) lines are permitted. ARGO NAVIS™ will flag missing or incorrectly formatted fields as errors and the transfer will be aborted if they are encountered. The entry format is –

**NAME | RA | DEC | OBJECT TYPE | MAGNITUDE | OPTIONAL DESCRIPTION**

NAME can be up to 32 characters long but must be unique within the first 16 characters. Names are case sensitive. Therefore the object 'BEBOP GALAXY' is regarded as different to the object 'bebop galaxy'. Names must not begin with a '#' character.

RA is expressed in hours, minutes and seconds. Many formats are acceptable such as 12:34:56, 12:34.5, 12:34, etc.

DEC is expressed in degrees. Many formats are acceptable including 12:34:56, 12:34.5, 12.34, +12:34:56, -12:34, etc. Don't forget the '-' sign for Southern objects.

OBJECT TYPE is case insensitive and can be one of –

- ASTERISM
- ASTEROID
- BRIGHT[ NEBULA]
- COMET
- DARK[ NEBULA]
- DOUBLE[ STAR]



ARGO NAVIS™

- EMISSION[ NEBULA]
- GALAXY
- GALAXY CL[USTER]
- GLOBULAR[ CLUSTER]
- NEBULA
- OPEN[ CLUSTER]
- PLANETARY[ NEBULA]
- REFLECTION[ NEBULA]
- STAR
- TRIPLE[ STAR]
- USER
- VARIABLE[ STAR]

The characters between the square brackets '[']' are optional. For example, you only need enter 'GALAXY CL' or 'galaxy cl' for 'GALAXY CLUSTER'.

In [MODE IDENTIFY](#) and [MODE TOUR](#), '**FIND**' searches will match both the type you specified as well as the type 'USER OBJECT'. For example, if you loaded an object with the type 'GALAXY', you can search for it by specifying 'GALAXY' or 'NON STELLAR' or 'USER OBJECT'.

If you give the object the type 'USER', then '**FIND**' searches will only match it if you specify 'USER OBJECT'.

If you give the object the type 'ASTEROID' or 'COMET', the object will only appear in the USER catalog and not the ASTEROID or COMET catalogs. However, [MODE IDENTIFY](#) and [MODE TOUR](#) '**FIND**' searches will still match it if you specify 'ASTEROID' or 'COMET'. This can be handy if you know the RA and Dec of an asteroid or comet on the night you wish to observe but do not know its orbital elements.

MAGNITUDE can be in the range  $-26.7$  to  $+28$  or the special keyword ANY (or any). Use ANY if you do not know the magnitude, or if a magnitude is not appropriate for the entry. An empty magnitude field is equivalent to ANY.

The OPTIONAL DESCRIPTION can either be left empty or can be any number of characters as long as the entire line entry does not exceed 254 characters. A combination of upper and lower case characters can be used if desired.

Generally upper case letters tend to look better on character LCD's and are therefore recommended where practical. The 'Caps Lock' key on your keyboard can aid in typing large amounts of text in uppercase.

### Transferring catalog files

To transfer Asteroid, Comet, Satellite or User Files, first ensure that your [SETUP SERIAL BAUD](#) rate matches that of ARGONAUT™ and that the STARTUP command is set to "navis". If





changing the STARTUP, the unit needs to be powered OFF and then ON for the new STARTUP to start. Place the unit in [SETUP\\_LOAD\\_CAT](#) mode. Then use the Transfer pull down menu and select the appropriate file type –

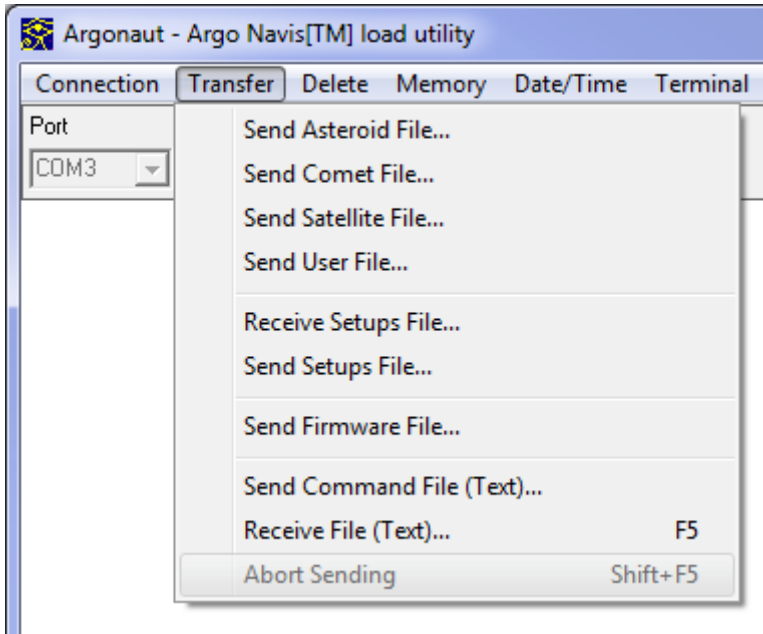

Then use the file navigation dialog to select the appropriate file –

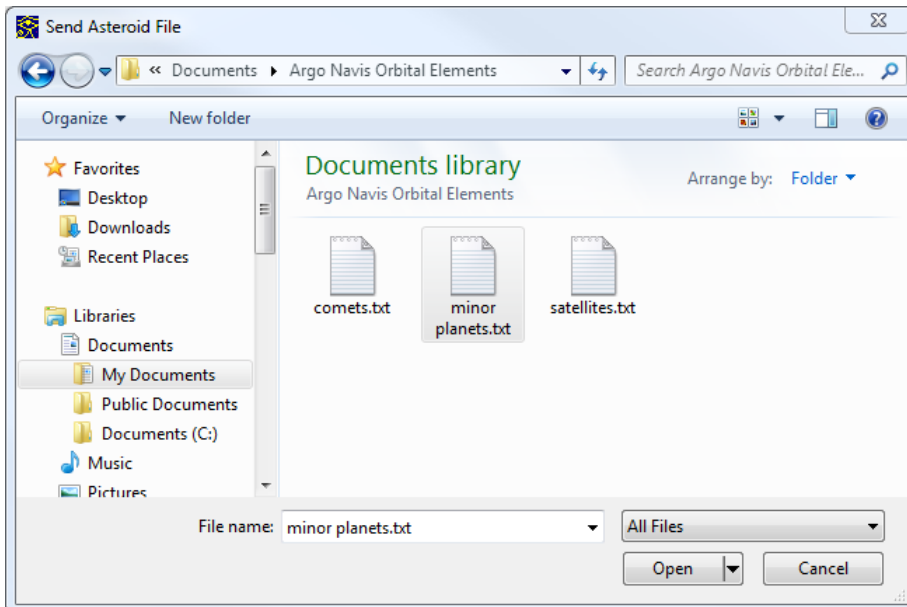

Then press Open. The file transfer should begin. In the Terminal window you should see ARGO NAVIS™ ‘echo’ each line from the file it receives from ARGONAUT™. As it processes each line, it also reports ‘OK’. The File Transfer Progress meter in the lower left hand corner should also indicate the transfer is taking place –

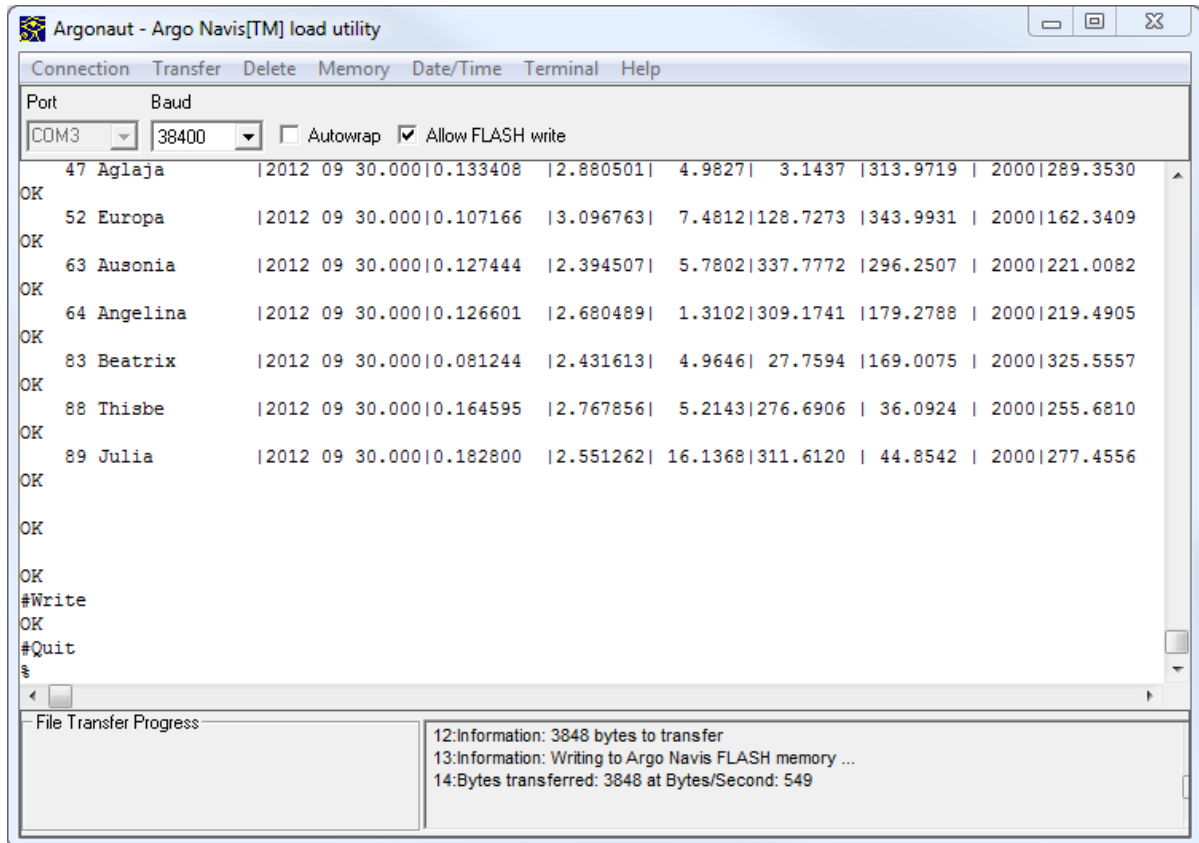

At the same time the transfer is taking place, status information will also be shown on the bottom line of the ARGO NAVIS™ display. For example, if you were transferring an Asteroid file you would see –

LOAD CATALOG  
ASTEROID LOAD..

When the file is transferred, ARGONAUT™ sends ARGO NAVIS™ a ‘#Write’ command. This tells ARGO NAVIS™ to commit the data to FLASH memory. This write operation takes a second or so. In the example of an Asteroid file, the ARGO NAVIS™ display will show –

LOAD CATALOG  
ASTEROID WRITE...



Then ARGONAUT™ sends ARGO NAVIS™ a '#Quit' command, which signals the end of the transfer. For example, in the case of an asteroid file transfer, the ARGO NAVIS™ display will show something like this –

```
LOAD CATALOG  
ASTEROID FINISH
```

If you have no more data to transfer, press the **EXIT** button on ARGO NAVIS™. The display will show for a few seconds –

```
LOAD CATALOG  
INITIALIZING ...
```

before returning to the SETUP menu level. Your catalog will now be loaded. The FLASH memory will retain it even if you power the unit off.

During and after the transfer you should also examine the Status panel on the lower-right hand corner of ARGONAUT™. Combined with the Terminal window transcript and the ARGO NAVIS™ display, it can provide you with valuable information that may help you understand what went wrong with an aborted or 'hung' transfer.

For example, in the case of a good transfer, you might see something similar to this –

```
1:Welcome to Argonaut  
2:Information: 3848 bytes to transfer  
3:Information: Writing to Argo Navis FLASH memory ...  
4:Bytes transferred: 3848 at Bytes/Second: 549
```

In the case where you have forgotten to put ARGO NAVIS™ into LOAD CAT mode, you might see this –

```
1:Welcome to Argonaut  
2:Information: 3848 bytes to transfer  
3:Timeout: Is Argo Navis in SETUP LOAD CAT mode?  
4:Timeout: Is Argo Navis in SETUP LOAD CAT mode?
```

## Updating catalog entries

You can edit and re-load an existing catalog at any time using the [same procedure](#) that you used for loading them.

Whenever a loadable catalog entry is transferred, ARGO NAVIS™ examines the first 16 characters of the object's name. If the first 16 characters match an existing entry, ARGO NAVIS™ updates that entry with the new data.



For example, say you had previously loaded the satellite orbital elements for the Hubble Space Telescope. The orbital element file entry might have listed this object under the name 'HST'. If you load a new satellite orbital element file that also has an entry for 'HST', then your old entry will be replaced by the new entry, which is probably what you wanted to do.

However, as a further example, say you had loaded an object with the name 'SUPERNOVA DISCOVERY 1'. Then, at a later time, you loaded an object with the name 'SUPERNOVA DISCOVERY 2'. Since both of these names are not unique within the first 16 characters, the second object will replace the first. If you had really wanted them to be two distinct objects, then you should rename them before loading them. For example, you might rename them 'SUPERNOVA 1 DISCOVERY' and 'SUPERNOVA 2 DISCOVERY'.

Loadable catalog entries will not replace objects in the ARGO NAVIS™ [in-built catalogs](#). The loadable catalogs reside in a different part of the unit's memory. For example, in the in-built NGC catalog, there is an entry for 'NGC 1234'. If you download your own object that is also named 'NGC 1234' then it is regarded as a totally separate object.

When you edit and re-load a catalog file, any objects that you deleted from that file will be still present within ARGO NAVIS™ until you [delete](#) them from there as well.

## Deleting loadable catalogs

Loadable catalogs can be deleted on a catalog-by-catalog basis.

ARGONAUT™ currently offers no support for deleting individual object entries. For this reason you should maintain your source catalog files on your PC so that you can edit and reload them into ARGO NAVIS™ as need be.

To delete an ARGO NAVIS™ catalog, the unit needs to be [set-up the same](#) way as when you [transferred](#) files. Make sure that it is in the [SETUP LOAD CAT](#) state. Then use the ARGONAUT™ Delete pull-down menu to select the catalog type you would like to purge –

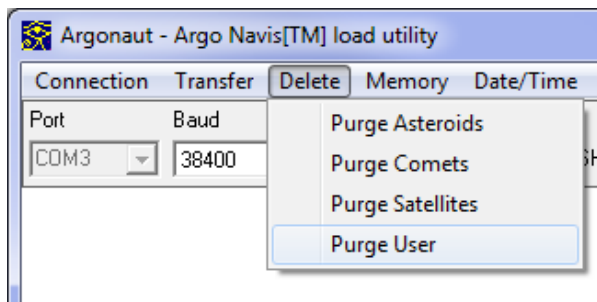

If you study the output in the Terminal window, you will see that ARGONAUT™ will send an "asteroid", "comet", "satellite" or "user" command, as appropriate, followed by "#Purge", "#Write" and "#Quit" commands. ARGO NAVIS™ will display a "FINISH" message when the catalog purge is complete.



If you have new catalogs to transfer, you can now load them.

## Querying loadable catalog free memory

You can use ARGONAUT™ to query how much free memory ARGO NAVIS™ has in its loadable catalog memory pool.

To perform this, the unit needs to be [set up the same](#) way as when you [transferred](#) files. Make sure that it is in the [SETUP LOAD CAT](#) state. Then use the ARGONAUT™ Memory pull-down menu and select Report Free Memory –

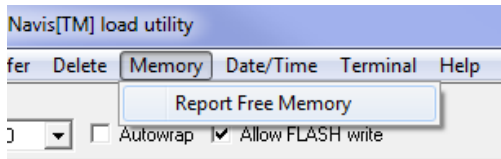

The amount of free memory in bytes is reported in the lower right hand Status window –

```
1:Welcome to Argonaut
2:Information Argo Navis reports bytes free: 119999
```

Keep in mind that ARGO NAVIS™ might report that there is some free memory but it may not be sufficient to hold new entries.

When no catalogs are loaded, the amount of available free memory is approximately 125535 bytes (approx. 123KB).

## Transferring setups

ARGO NAVIS™ allows you to save your current [SETUP](#) menu parameters held in [EEROM](#) to a file on a PC. It also allows you to restore setups from that file back into the ARGO NAVIS™ [EEROM](#) so they appear in the [SETUP](#) menu.

Since some firmware upgrades will need to automatically reset the [EEROM](#) to its factory default settings, this is a handy feature that enables you to save your setups prior to performing the upgrade and to then restore them afterwards.

In the previous sections it was explained how you can use ARGONAUT™ to transfer loadable catalogs. This section explains how you can transfer ARGO NAVIS™ setups. You should make yourself familiar with the set-up and running of ARGONAUT™ as explained in the previous sections, as that part of the operation is similar and will not be explained again in detail here.

Ensure that your [SETUP SERIAL](#) BAUD rate matches that of ARGONAUT™ and that the STARTUP command is set to “navis”. If changing the STARTUP, the unit needs to be powered OFF and then ON for the new STARTUP to start.



ARGO NAVIS™

## Receiving setups from ARGO NAVIS™ to PC

To receive the current setups from the ARGO NAVIS™, first place the unit in [SETUP LOAD CAT](#) mode. Then use the Transfer pull down menu and select “Receive Setups File...”–

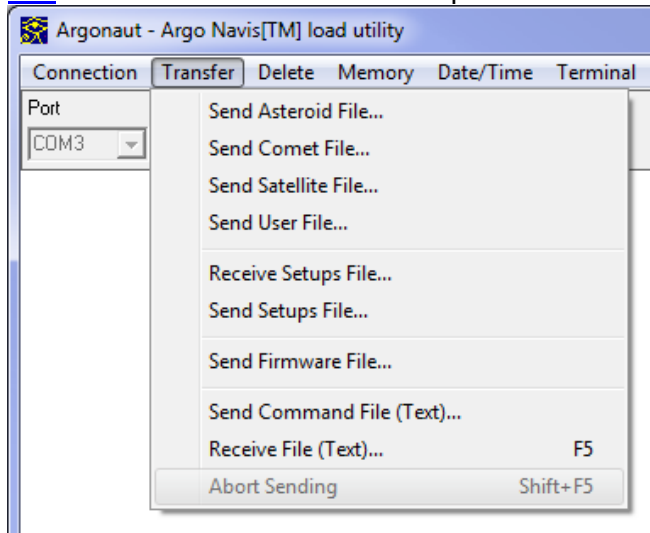

Then use the file navigation dialog to select an appropriate folder and type in the name of a file into which you would like to record the setups. If you suffix the name of the file with “.txt” then the file can also be examined with a plain text editor such as NotePad™–

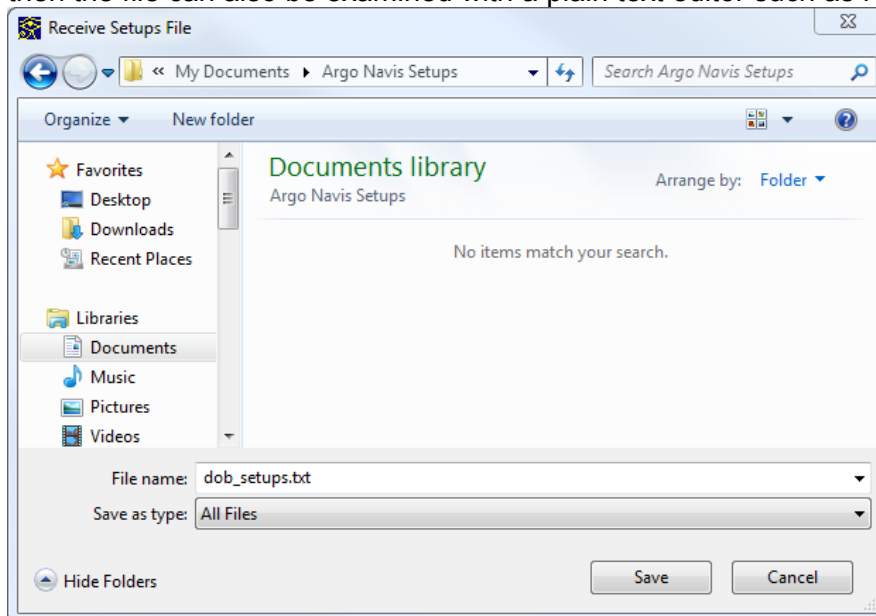

Then press Save. The setups transfer should begin. In the Terminal window you should see ARGO NAVIS™ ‘echoing requests from ARGONAUT™ to “Read” a parameter and then you should see ARGO NAVIS™ transmit that parameter. The File Transfer Progress meter in the lower left hand corner should also indicate the transfer is taking place –

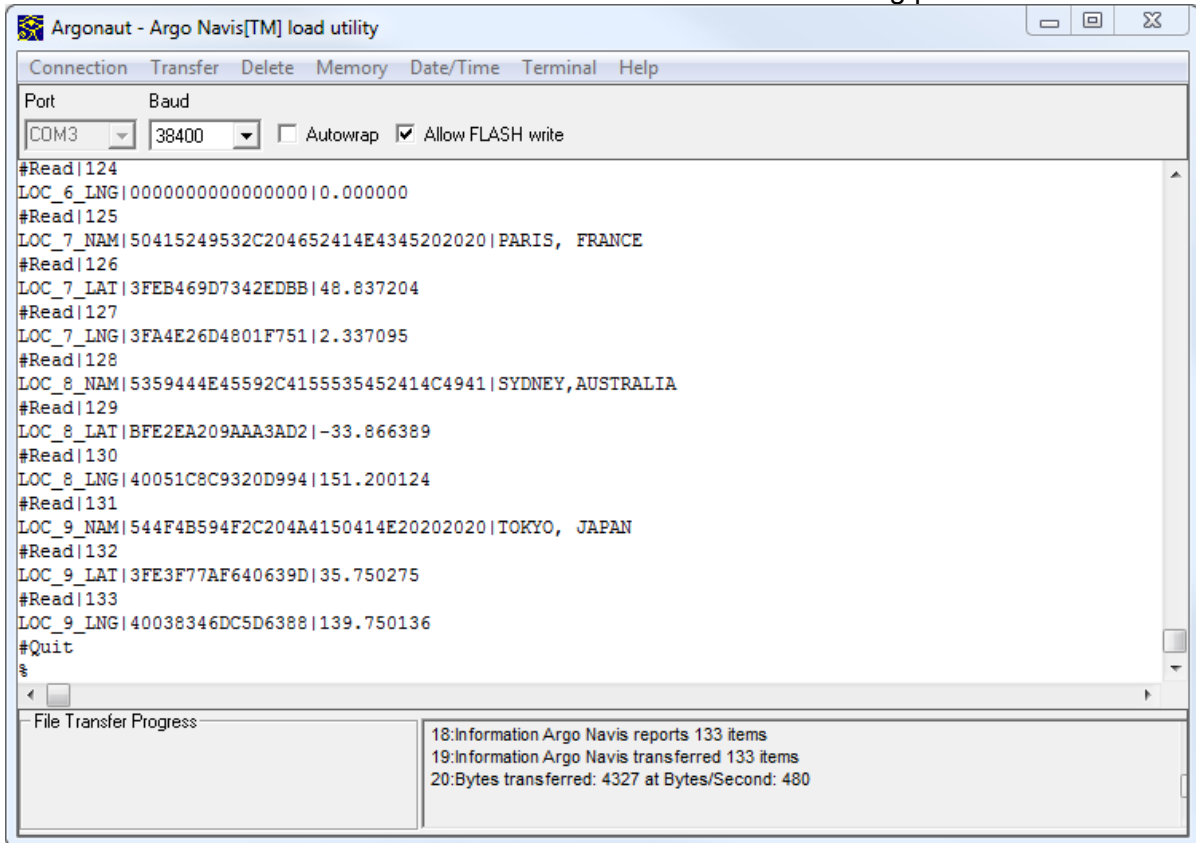

At the same time the transfer is taking place, status information will also be shown on the bottom line of the ARGO NAVIS™ display. For example, during the transfer you would see –

LOAD CATALOG  
SETUPS..

When the data transfer is complete, ARGONAUT™ sends ARGO NAVIS™ a ‘#Quit’ command. The ARGO NAVIS™ display will show –

LOAD CATALOG  
SETUPS FINISHED





Note that if you have additional setups that are saved in the [SETUP ARCHIVE](#) FLASH memory archive, you should do the following. For each setup, use the [SETUP ARCHIVE](#), LOAD SETUP functionality to load it into [EEROM](#) and then use the ARGONAUT™ “Receive Setups File...” menu to store it into a file with a unique identifying name on your PC.

### **Sending setups from PC to ARGO NAVIS™**

To load setups into your ARGONAUT™ from a file on your PC, first place the unit in [SETUP LOAD CAT](#) mode. Then use the Transfer pull down menu and select “Send Setups File...”–

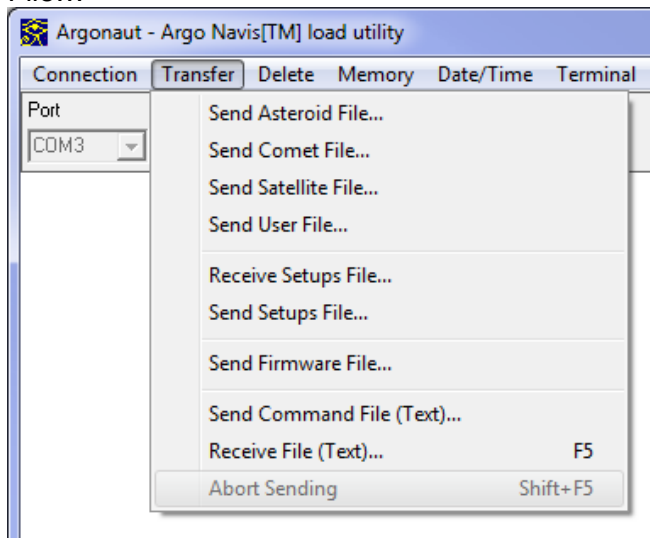

Then use the file navigation dialog to select the file that you had previously created when you had transferred setups from ARGONAUT™ to your PC –

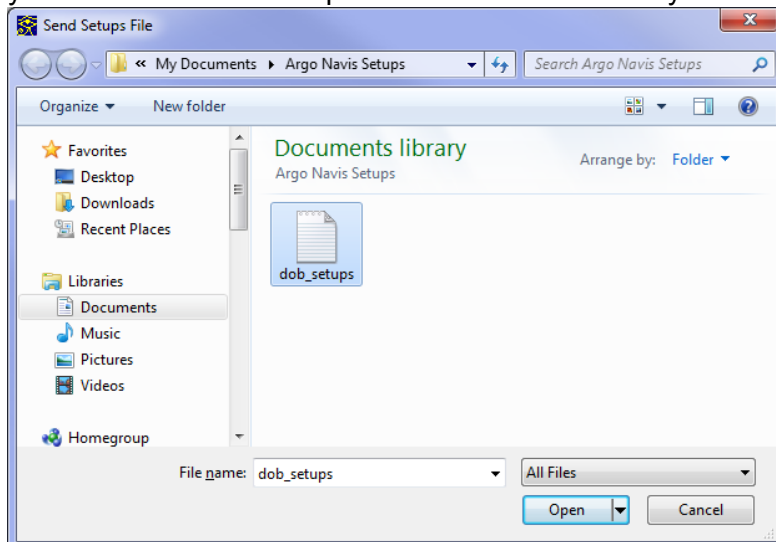

Then press Open. The setups transfer should begin. In the Terminal window you should see ARGONAUT™ echoing requests from ARGONAUT™ to “Write” a parameter and then you should see ARGONAUT™ acknowledge each parameter transfer with “OK”. The File Transfer Progress meter in the lower left hand corner should also indicate the transfer is taking place –

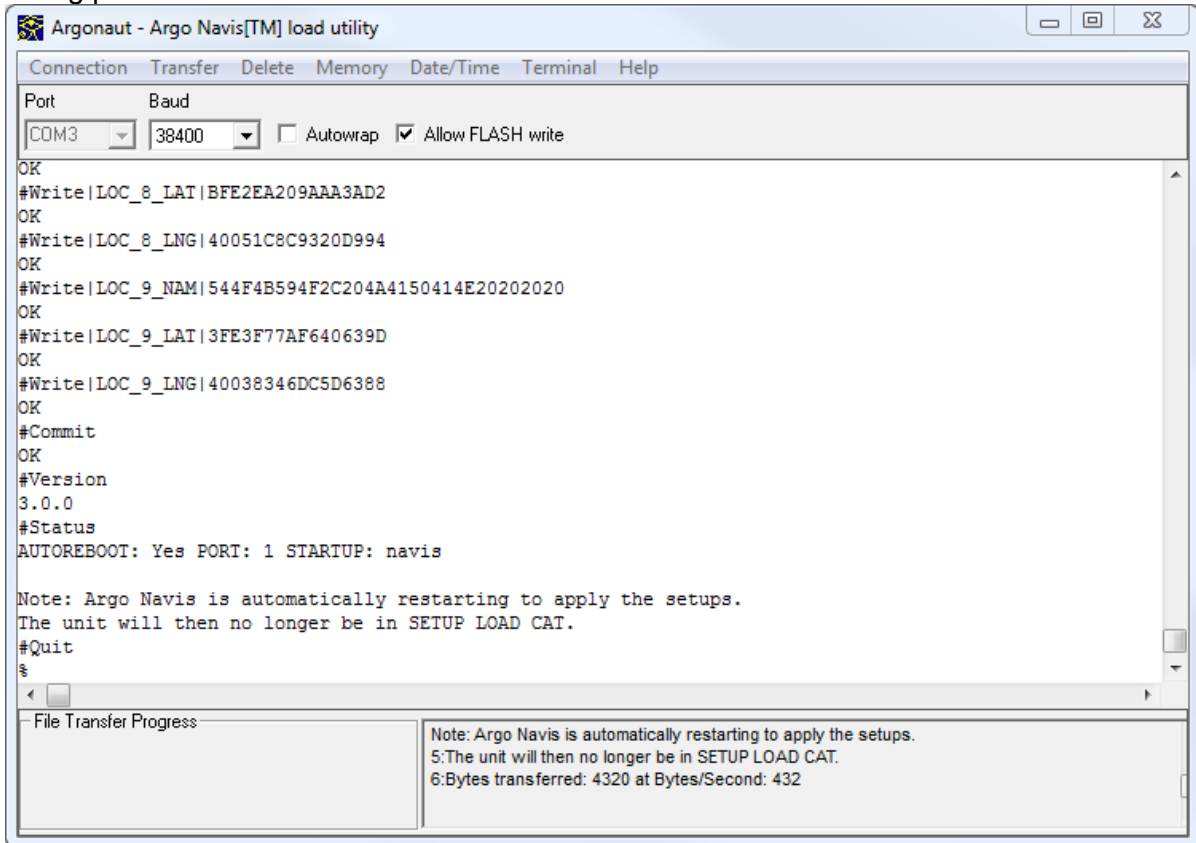

At the same time the transfer is taking place, status information will also be shown on the bottom line of the ARGONAUT™ display. For example, during the transfer you would see –

LOAD CATALOG  
SETUPS..

When the data transfer is complete, ARGONAUT™ sends ARGONAUT™ a “#Commit” command to commit the setups to [EEROM](#). The display will show -

LOAD CATALOG  
SETUPS FINISHED



It then issues a '#Version' command and ARGO NAVIS™ reports the current firmware version. It next issues a "#Status" command. If ARGO NAVIS™ reports "AUTOREBOOT: Yes", then an automatic reboot is required and will take place. It also reports what serial port number you are currently connected to and what STARTUP command will be running on the serial port when the next reboot takes place.

If your setup file loaded a different STARTUP command than "navis" or a different BAUD rate then ARGONAUT™ will not be able to communicate with the unit until you change these parameters.

Similarly, if an automatic reboot takes place, ARGO NAVIS™ will no longer be in the [SETUP LOAD CAT](#) menu. To continue using some ARGONAUT™ commands, the unit needs to be in the [SETUP LOAD CAT](#) menu.

Note that if you have additional setups that you would like loaded into the [SETUP ARCHIVE](#) FLASH memory archive, after loading each one you should use the [SETUP ARCHIVE](#), STORE SETUP functionality to move it from [EEROM](#) into the archive.

## Transferring firmware files

A key feature of ARGO NAVIS™ is the ability to upgrade its firmware via the serial port. Wildcard Innovations periodically offers free firmware upgrades on [their web site](#). After downloading the firmware file via the Internet, you can then transfer it to your ARGO NAVIS™. Some of the key benefits of this include –

- New features and enhancements
- New catalogs, catalog corrections and improved descriptions
- Bug fixes
- It's free

For these reasons it is worthwhile acquiring the optional serial cable (pn-ser-cbl) if you have not done so already.

The ARGO NAVIS™ FLASH memory area is divided into four regions –

- Boot Loader
- Firmware including in-built catalogs
- Archived setups
- Loadable catalogs

The Boot Loader area cannot be erased. The Firmware and Loadable catalog areas, however, can be erased and re-written. The ARGONAUT™ utility services this function.

In the previous sections it was explained how you can use ARGONAUT™ to transfer loadable catalogs. This section explains how you can upgrade the ARGO NAVIS™ firmware. You should make yourself familiar with the set-up and running of ARGONAUT™ as explained



in the previous sections, as that part of the operation is similar and will not be explained again in detail here. However, there are some key differences in how the ARGO NAVIS™ unit needs to be set-up in order to perform a firmware upgrade.

To upgrade the firmware, perform the following steps -

If you have not done so already, register your unit on the [Wildcard Innovations Registration web site page](#). Record your Registration Code.

By following the links on the [Wildcard Innovations Firmware Upgrades web site page](#), enter your Registration Code and download a firmware upgrade file. The firmware file will have a '.sgz' suffix. Check that the downloaded file size is identical to the size of the file on the web site. The firmware file is in a format that is ready for ARGONAUT™ to transfer. You do not need to unzip it.

Before upgrading your firmware, it is a good idea to make a copy of your [SETUP](#) menu settings. Some firmware upgrades will need to automatically reset the [EEROM](#) to its factory default settings. The easiest way to do this is to use the ARGONAUT™ "Receive Setups File..." functionality. Alternatively transcribe your [SETUP](#) menu settings by pen and paper.

Some firmware upgrades may also automatically clear the loadable catalog region. Therefore any objects that you have loaded might be erased. Make sure you retain the original catalog source files on your PC.

Power off the ARGO NAVIS™ unit. If you are powering your unit from batteries, ensure that they are fresh.

Connect the serial cable to the **SERIAL1** port of ARGO NAVIS™. Only the [SERIAL1](#) port can be used for firmware upgrades and during this operation its Baud rate is fixed at 38400. Make sure the other end of the cable is connected to your PC's serial port.

Start ARGONAUT and set the appropriate COM port. Also ensure that ARGONAUT™ is set at 38400 Baud rate. Use the Connection pull-down menu, and Connect to the COM port.

On ARGO NAVIS™, press and keep depressed the **EXIT** button and then power the unit on. The display should show something similar to this –

**BOOT LOADER**  
**1.0.X**

where 'X' is a digit representing the version of the Boot Loader.

Now release the **EXIT** button. ARGO NAVIS™ is now running exclusively out of its Boot Loader region in the FLASH memory. The Boot Loader's job is to take commands and data from ARGONAUT™ and write the data to the Firmware area.

Check the ARGONAUT™ Terminal window. If it says "USE OTHER PORT" then you have inadvertently plugged the connector into ARGO NAVIS™ **SERIAL2** port.

Otherwise, as a test of communications, try typing a '?' character in the Terminal window followed by the keyboard's 'Enter' key. ARGO NAVIS™ should respond with 'OK'.



Now use the Transfer pull-down menu and select Send Firmware File. A file navigation dialog should pop-up. Select the appropriate firmware file and press Open.

The Terminal window should now start filling with 'OK' responses from ARGO NAVIS™. You can monitor progress by watching the File Transfer Progress meter, and by watching the ARGO NAVIS™ display. After the first 2% is transferred, ARGO NAVIS™ should show –

**BOOT LOADER  
2% RECEIVED**

Further progress is shown in 2% increments. The transfer should typically take between 25 to 90 minutes. When the display says that 100% has been transferred, power off your ARGO NAVIS™ and power it on normally. If your unit should fail to initialize, check the batteries and then try setting factory defaults in the EEROM as follows. Power off your unit, press and keep depressed both the **ENTER** and **EXIT** buttons. Power on your unit. After initialization, release the buttons. If the unit still fails to initialize, put it in BOOT LOADER mode again and try repeating the firmware installation.

You will then want to restore any setups you had using the ARGONAUT™ “Send Setups File...” functionality or if you recorded them by pen and paper, by entering each into the appropriate SETUP menu.

If you had any loadable catalog entries that you would like to re-load, use ARGONAUT™ to restore them.

Be sure to regularly check the [Wildcard Innovations web site](#) for firmware upgrade announcements.

## Setting the date/time from your PC to ARGO NAVIS™

ARGO NAVIS™ has a built-in battery-backed time-of-day clock. An internal lithium coin cell battery powers the clock even when the power is switched off or the main batteries are removed.

You can manually set the date and time using the [SETUP DATE/TIME](#) menu.

Alternatively you can use ARGONAUT™ to transfer the current date and time on your PC to ARGO NAVIS™.

### Network Time Protocol package

Having the time accurately set is critical when wishing to observe fast moving man-made satellites. In this case it is also important that the time on your PC is also accurately set.

One of the best ways to ensure that your PC's time is accurately maintained is to use the Network Time Protocol (NTP). This protocol uses a network of servers on the Internet to synchronize the time on your own computer to within a few milliseconds.



Although all versions of Windows™ since Windows 2000™ include the Windows™ Time Service (“W32Time”) which utilizes NTP, Microsoft state that their W32Time service can only reliably maintain sync to within 1 to 2 seconds. For higher accuracy, Microsoft recommends using an alternative NTP implementation.

An NTP implementation that Wildcard Innovations recommends is the Meinberg NTP package. It includes a GUI installer and documentation. It is available for free download and can be found by following the links at the [Meinberg web site](http://www.meinbergglobal.com/english/faq/faq_28.htm).

An alternative step-by-step guide to installing and setting up the Meinberg NTP server can be found at <http://www.satsignal.eu/ntp/setup.html>

After performing the installation it is important to double-check that the Windows™ Time Service is disabled. If it is enabled, it will contend with the newly installed Meinberg NTP service. To check whether the Windows™ Time Service has been disabled, from the Windows™ Control Panel select “Date and Time”. From the “Internet Time” tab ensure that it says “This computer is not set to automatically synchronize with an Internet time server”. If it is still enabled, use the “Change settings...” button.

As part of the installation, Meinberg also provides the “Quick NTP Status” command which can be found in the Windows Start menu in the Meinberg->Network Time protocol folder. We highly recommend you run it to check that your NTP client is successfully in contact with NTP servers. An example window is shown here –

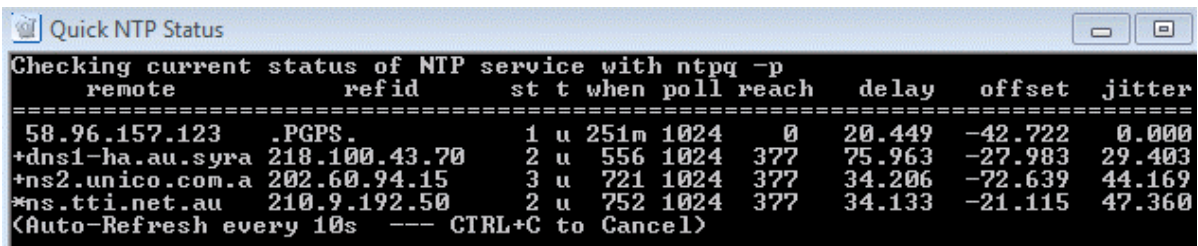

```

Quick NTP Status
Checking current status of NTP service with ntpq -p
=====
remote          refid          st t when poll reach  delay  offset  jitter
=====
58.96.157.123   .PGPS.        1 u 251m 1024   0   20.449 -42.722  0.000
+dns1-ha.au.syra 218.100.43.70 2 u 556 1024 377 75.963 -27.983 29.403
+ns2.unico.com.a 202.60.94.15 3 u 721 1024 377 34.206 -72.639 44.169
*ns.tti.net.au  210.9.192.50 2 u 752 1024 377 34.133 -21.115 47.360
<Auto-Refresh every 10s --- CTRL+C to Cancel>

```

Take note of the “reach column”. This indicates whether your NTP client has been able to reach the corresponding NTP server time reference source. When your client first starts, the reach values will be 0. After a few minutes, one or more should become non-zero. If they remain 0, then there is a problem with the installation. A common issue is that the Windows™ Firewall may require you to add rules to enable UDP protocol both inbound and outbound on port 123. The Meinberg web site addresses Windows™ Firewall configuration on their web site here - [http://www.meinbergglobal.com/english/faq/faq\\_28.htm](http://www.meinbergglobal.com/english/faq/faq_28.htm)

The Meinberg NTP service runs quietly in the background as a Windows™ service and once installed will start automatically each time your PC is booted. It can reliably maintain your PC’s clock to within milliseconds. The next time you re-boot your PC use the “Quick NTP Status” command to check the service is running and that the servers are being reached.



### Using ARGONAUT™ to set the ARGO NAVIS™ date/time

Ensure that your [SETUP SERIAL](#) BAUD rate matches that of ARGONAUT™ and that the STARTUP command is set to “navis”. If changing the STARTUP, the unit needs to be powered OFF and then ON for the new STARTUP to start.

ARGO NAVIS™ *does not* need to be in the [SETUP LOAD CAT](#) mode to use this feature.

Use the Date/Time pull down menu and select “Set Date/Time”–

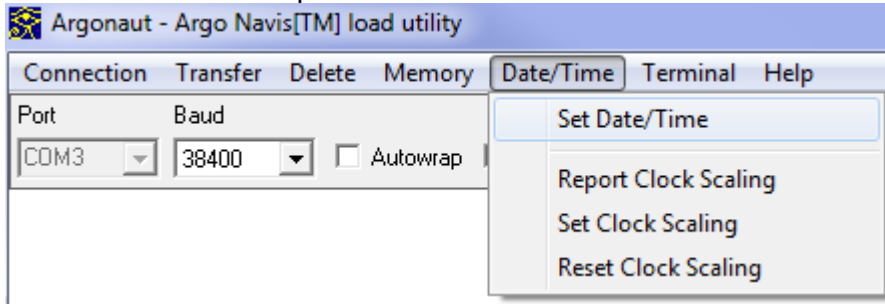

In the Terminal Window area, you should see ARGO NAVIS™ echoing a command from ARGONAUT™ to set the date/ time in the form of a [Julian Date](#) (JD). ARGONAUT™ then sends commands for ARGO NAVIS™ to make a sound and report back the new UTC and local date/time -

```

%
% date -e
176876
%
date -s 2457008.73974537
% sound
% date -u
05:45:15 WED 17 DEC 2014 UTC
% date
15:45:15 WED 17 DEC 2014 Local
%

```

### Scaling the ARGO NAVIS™ time-of-day clock

The ARGO NAVIS™ time-of-day clock uses a quartz crystal with a nominal frequency of 32768Hz. However, due to manufacturing tolerances a crystal can oscillate at a slightly different frequency.

For most practical purposes, these tiny frequency differences will not impact upon the ability of ARGO NAVIS™ to reliably locate and identify objects. For many users, the





frequency provided by the crystal is accurate enough that it can go for an extended period without needing to set the date and time.

Temperature, shock and vibration and ageing can also cause a quartz crystal to deviate slightly from the nominal frequency.

For observing fast moving man-made satellites, split-second timing can be a necessity. The ability to set the date/time from a PC running a Network Time Protocol (NTP) client can assist in ensuring that the ARGO NAVIS™ time is accurately set. This function was described in the section on "[Setting the date/time from PC to ARGO NAVIS™](#)".

As a further aid, ARGO NAVIS™ has a feature whereby its time-keeping can be scaled in software by a simple linear model. Once the date/time has been accurately set, the software clock scaling feature can often assist in maintaining the accuracy of the time over a longer period.

ARGONAUT™ has special features to -

- Report on the ARGO NAVIS™ software clock scaling performance.
- Compute and apply software clock scaling.
- Reset the software clock scaling.

Whenever the ARGO NAVIS™ time-of-day-clock is set, either via the [SETUP DATE/TIME](#) menu or from the PC, the time at which this took place is recorded within the ARGO NAVIS™ [EEROM](#).

ARGO NAVIS™ bases its internal time on a virtual software clock. The rate at which the software clock runs is equivalent to that of the hardware clock rate multiplied by a scaling parameter stored within [EEROM](#) referred to as the "Current Scale" or curScale for short.

- The factory default value of curScale is 1.
- All real-world curScale values will be very close to 1.
- A value less than 1 will scale the time provided by ARGO NAVIS™ to run slower.
- A value greater than 1 will make it run faster.

For example, a scale value of 1.000023148 will cause the ARGO NAVIS™ clock to run faster by about 2 seconds a day.

The ARGONAUT™ Report Clock Scaling menu provides a list of parameters on the hardware clock and software clock performance compared against the current PC clock time as a reference -



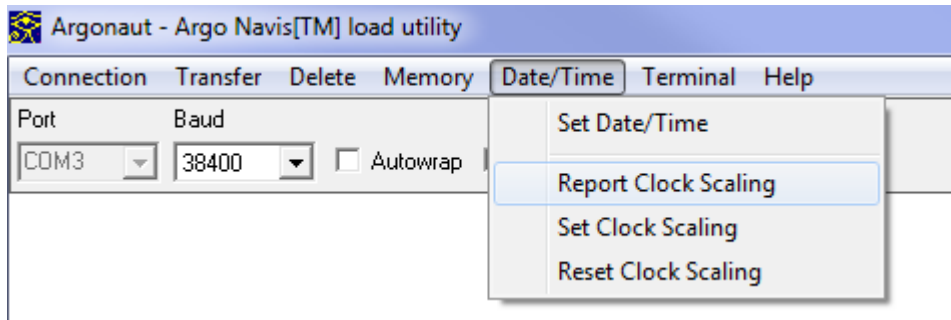

For example, below is the output from one ARGO NAVIS™—

```
Elapsed: 24563 s Temp: 21.8 C hwDelta: 0.0514 s swDelta: 0.0826 s hwPPM: 2 swPPM: 3
hwJD: 2457010.38647588 swJD: 2457010.38647551 curScale: 1.0000000000000000 hwScale:
1.000002092480010 swScale: 1.000003364741211
```

“Power users” might be interested as to what the parameters mean -

- Elapsed: Time in seconds since ARGO NAVIS™ time was last set.
- Temp: Temperature inside unit in degrees Celsius.
- hwDelta: How far ahead or behind in seconds the PC clock is compared to the ARGO NAVIS™ hardware clock.
- swDelta: How far ahead or behind in seconds the PC clock is compared to the ARGO NAVIS™ software clock.
- hwPPM: Calculated accuracy of ARGO NAVIS™ hardware clock compared to PC clock in parts-per-million.
- swPPM: Calculated accuracy of ARGO NAVIS™ software clock compared to PC clock in parts-per-million.
- hwJD: Current Julian Date as derived from ARGO NAVIS™ hardware clock.
- swJD: Current Julian Date as derived from ARGO NAVIS™ software clock.
- curScale: Current Scale factor stored in EEROM.
- hwScale: Scale factor of ARGO NAVIS™ hardware clock compared to PC clock calculated over the time-base of ‘Elapsed’ seconds. If hardware clock were “perfect” then this ideally would have a value of exactly 1. However, it will normally be some value close to 1. If it is less than 1, then the hardware clock is running faster than the PC clock. If it is greater than 1, it is running slower than the PC clock. It is independent of what the “curScale” is but ideally curScale would be identical to it.
- swScale: Scale factor of ARGO NAVIS™ software clock compared to PC clock calculated over the time-base of ‘Elapsed’ seconds. If it is less than 1, then the software clock is running faster than the PC clock. If it is greater than 1, it is running slower than the PC clock. It is dependent on the value of “curScale” and ideally would be 1. The goal of the ARGONAUT™ clock scaling feature is to in fact make it as close to 1 as possible.



If using the clock scaling feature, you should ensure that the time on your PC is accurate. Specifically, your machine should be running the Network Time Protocol (NTP) which then helps ensure that the PC is in sync with a global array of servers providing precision time references. Use the Meinberg “Quick NTP Status” command discussed earlier to ensure that your NTP client is reaching NTP servers and synchronizing with them.

Having ensured that your PC time is now keeping accurate NTP-synced time, one initially sets the ARGO NAVIS™ time by using the ARGONAUT™ Set Date/Time menu –

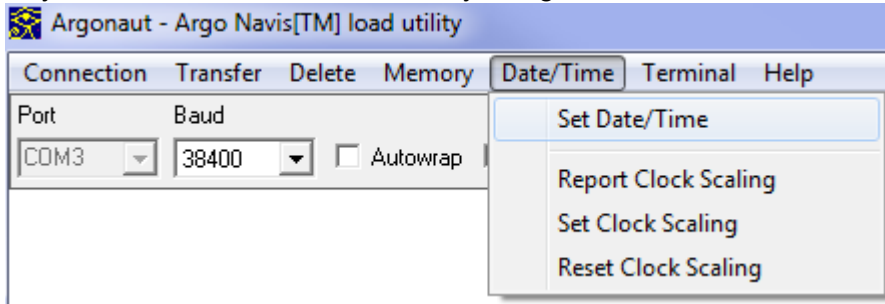

At any time, you can run the Report Clock Scaling menu and ARGO NAVIS™ will provide a list of parameters as mentioned above. This is a "power user" feature, but nevertheless if the PC is reliably running NTP it can provide valuable feedback on your ARGO NAVIS™ clock performance.

In order to estimate the clock scaling, ARGO NAVIS™ requires a long baseline of time. Ideally this would be many weeks.

However, ARGONAUT™ allows you to first estimate and apply clock scaling 6 hours (equivalent to an Elapsed: 21600 seconds) after you set the time. It purposely prevents you from attempting to apply scaling earlier but will tell you when you can next try.

To compute and apply scaling, use the Set Clock Scaling menu –

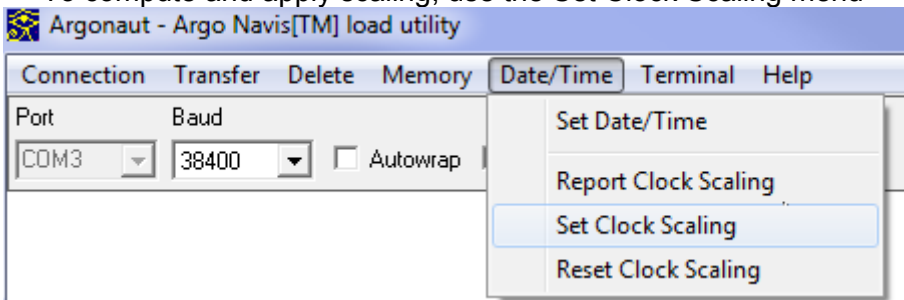

ARGONAUT™ will then take 10 samples and report an average hardware scale value (avhwScale parameter). It will automatically store this parameter into [EEROM](#) as the new curScale value.

The whole process only takes a few seconds. It is then instructive to run Report Clock Scaling again. Below is an example output –

```
Elapsed: 61386 s Temp: 29.5 C hwDelta: -0.0362 s swDelta: 0.0055 s hwPPM: -1 swPPM: 0.
hwJD: 2457010.81267958 swJD: 2457010.81267910 curScale: 0.999999319956983 hwScale:
0.999999410164669 swScale: 1.000000090210653
```



The parameter to look at immediately is -

- swDelta, which is measured in seconds and is the PC clock time compared to the software clock time, should now be very small.

Some other parameters that are interesting to look at are -

- swScale should be close to 1. The ideal swScale value would be exactly 1.
- hwScale should be close to curScale. Ideally they would be the same.
- hwDelta time will always remain uncorrected as it reports on the time the actual time-of-day hardware clock is keeping without any scaling. In the example above it is
- swPPM is in terms of parts per million and is ideally small.
- hwPPM is in terms of parts per million and it reports on the performance of the crystal itself.

After the first time you perform Set Clock Scaling, you can then apply it at any time thereafter.

However, during this time you should refrain from using Set Date/Time again as doing so will disrupt the establishment of a long baseline of time to estimate your clock's performance. In any case, whenever you run Set Clock Scaling the scaling operation inherently synchronizes your ARGO NAVIS™ clock.

Then any subsequent time you wish to accurately set the date/time, you can now perform Set Clock Scaling operations in lieu of using the ARGONAUT™ Set Date/Time. Likewise, you should refrain from going into the ARGO NAVIS™ [SETUP DATE/TIME](#) menu. Entering and exiting into the date/time setting part of menu will also disrupt the baseline but simply changing your time zone will not. If you want to know the time, simply use [MODE TIME](#) in the top level menu.

Performing the Set Clock Scaling should not become obsessive. You might want to try again a full day after first setting the time, then perhaps a week later and then perhaps after a few weeks or a month, or before a satellite observing run.

If the parameters being reported back by successive Report Clock Scaling runs are erratic, then chances are that NTP is not reliably running on the PC and that it is the PC time that is drifting. In which case use the Meinberg "Quick NTP Status" command discussed earlier. One or more "reach values" must be non-zero.

If you ever want to set the scale factor back to 1, simply select Reset Clock Scale –

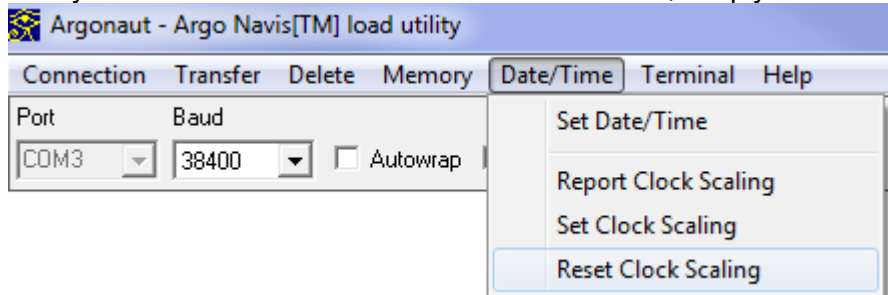

It is important to appreciate that the parameters ARGO NAVIS™ uses for clock scaling are stored on a per-setup basis. If you have additional setups stored in the [SETUP ARCHIVE](#), FLASH archive then each may have different clock scaling parameters.



## Linux™ operating system file transfer utilities

The ability to load and purge asteroid, comet, satellite and user catalogs as well as perform firmware upgrades is also supported for the Linux™ operating system. Two command line utilities are currently provided for Intel-based Linux™ platforms.

You can copy them from the supplied CD-ROM or download them from [Wildcard Innovations](#). You should move them into a suitable bin directory on your system. Make sure that the directory is in your execution path.

If installing from the CDROM, perform the following –

```
% mount /dev/cdrom <your mount point>
% cd <your mount point>/software/linux
% cp catload <suitable bin directory>
% cp sgzload <suitable bin directory>
```

You should read the sections of this manual concerning the ARGONAUT™ utility, which is supplied for the Windows OS™. This will give you the basic background you require for knowing how to create your catalog files and how to set-up ARGO NAVIS™ for performing a transfer.

### catload

The catload command is used to download or purge asteroid, comet, satellite or user catalogs.

The syntax is –

```
catload [-b baud rate] [-s serial port] -c command -f file | -p [-v] [-w]
```

The default Baud rate is 38400.

The default serial port is /dev/argo. You should determine which serial port device is in use on your system, for example, /dev/ttyS0.

The -c flag is for the catalog type either asteroid, comet, satellite or user.

The -f flag is followed by the name of your catalog input file.

The -p flag purges (removes) the specified catalog.

The -v flag prints the version number of catload and then exists.

The -w flag is essential if you want your catalog to be written to FLASH.

catload will give percentage milestones or error messages on standard output.



### **sgzload**

The *sgzload* command is used for loading firmware files. These have a '.sgz' suffix.

The syntax is –

```
sgzload [-s serial port] -f file [-v]
```

The default serial port is */dev/argo*.

The *-f* flag is followed by the name of the firmware file.

The *-v* flag will print the *sgzload* version number and then exit.

*sgzload* will give percentage milestones or error messages on standard output.

### **Mac OS X™ operating system file transfer utility**

The ability to load and purge asteroid, comet, satellite and user catalogs as well as perform firmware upgrades is also supported for the Mac OS X™ operating system.

The *Argoload* utility for Mac OS X™ can be downloaded from [Wildcard Innovations](#).

This utility is kindly provided by Jeff Terry and is based upon the Wildcard Innovations GNU Public License (GPL) open-sourced *catload* and *sgzload* Linux™ utilities. Wildcard Innovations have further contributed to *Argoload* and as at the time of writing have ported it to run on Mac OS X *Mountain Lion*™ 10.8, *Mavericks*™ 10.9 and *Yosemite*™ 10.10.

*Argoload* has a graphical user interface and supports the Keyspan™ USA-19HS USB Serial Adapter. These adapters can be purchased from [Wildcard Innovations](#) (Part No pn-usb) and are used in conjunction with the optional RS-232 serial cable ([Wildcard Innovations](#) Part No. pn-ser-cbl). Other USB Serial Adapters can be supported by end-user source-code modification.

After downloading the zip archive to your Mac, click on it to open it. Carefully follow the step-by-step installation instructions found in the *Instructions.txt* file.

The package includes the pre-compiled *Argoload* application plus source code which can be compiled using the free Mac OS-X *XCode*™ development package.

Thanks to Jeff Terry for providing *Argoload* to the ARGO NAVIS™/Mac OS X™ community.



ARGO NAVIS™



## Using ARGO NAVIS with the *ServoCAT* Track/GOTO Controller

### *ServoCAT* introduction

The *ServoCAT*<sup>™</sup> is a Track/GOTO controller manufactured by [StellarCAT](#). It drives a pair of servo motors and when combined with an ARGO NAVIS<sup>™</sup> can bring motorized “GOTO” and tracking to your mount. The term “GOTO” refers to the ability to dial up a target on your ARGO NAVIS<sup>™</sup>, press the “GOTO” button on the *ServoCAT*<sup>™</sup> hand controller and the mount will automatically “go to” the target. “Tracking” refers to the ability of the telescope to then continually follow the target without you having to manually push the mount. A view of the *ServoCAT*<sup>™</sup> front panel interface is shown here -

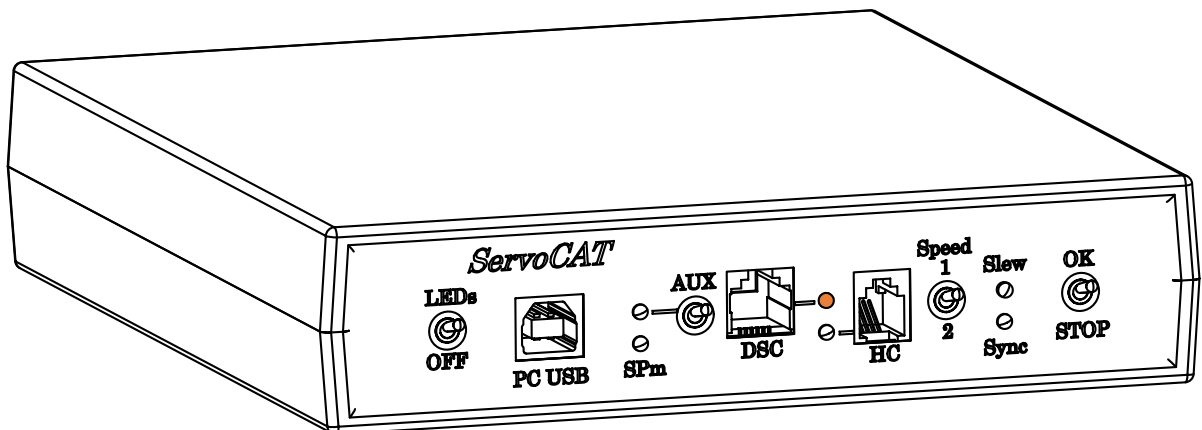

### Interfacing to *ServoCAT*<sup>™</sup> and setups configuration

ARGO NAVIS<sup>™</sup> interfaces to *ServoCAT*<sup>™</sup> via a proprietary serial cable, Wildcard Innovations Part No. pn-cat-cbl. [Email Wildcard Innovations](#) if you need to order one. Please note that this cable is different to the ARGO NAVIS<sup>™</sup> to PC serial cable, which is Part No. pn-ser-cbl.

Plug one end of pn-cat-cbl into either the **SERIAL 1** or **SERIAL 2** port of your ARGO NAVIS<sup>™</sup>. Plug the other end into the DSC port on the *ServoCAT*<sup>™</sup> (see illustration above).

Using the [SETUP SERIAL](#) menu, you need to configure the serial port you plan on using to have a BAUD rate of 19200 and a STARTUP command of “servocat”. Whenever you change the STARTUP command, you need to power the ARGO NAVIS<sup>™</sup> off and then on so that the new STARTUP command starts.



To minimize the chance of your mount accidentally slewing in altitude beyond its mechanical limits, configure the [SETUP GOTO](#), GOTO LIMITS submenu. The factory default settings for LOW and HI are very conservatively set and do not represent any limitation of the *ServoCAT*<sup>™</sup>. Adjust them to match your mount's capability. After performing a valid [MODE FIX ALT REF](#) step you can use the angular ALT reading in [MODE ENCODER](#) as a diagnostic to determine a safe LOW limit.

Whenever a GOTO is commanded, ARGO NAVIS<sup>™</sup> determines if the target is below the horizon. If it is, it communicates to the *ServoCAT*<sup>™</sup> that the slew would be unwise and *ServoCAT*<sup>™</sup> does not take the slew but instead sends a request to ARGO NAVIS<sup>™</sup> to play some down-beat warning notes. ARGO NAVIS<sup>™</sup> computes where the local horizon is based on your [MODE FIX ALT REF](#) step and alignment and the time zone and local time you entered in [SETUP DATE/TIME](#) and the latitude and longitude you set in [SETUP LOCATION](#). You should ensure that these parameters are correctly set.

### Operation with *ServoCAT*<sup>™</sup>

A few seconds after powering on both the ARGO NAVIS<sup>™</sup> and *ServoCAT*<sup>™</sup>, the red LED on the *ServoCAT*<sup>™</sup> next to the DSC port should start blinking. This indicates successful communication between the two.

Immediately after performing a valid alignment the red LED should go steady on. This indicates that an alignment has taken place.

If you dial up an object on ARGO NAVIS<sup>™</sup> that is currently above the horizon and above the [SETUP GOTO](#), GOTO LIMITS LOW limit and beneath the [SETUP GOTO](#), GOTO LIMITS HI limit and then press the green GOTO button on the *ServoCAT*<sup>™</sup> hand controller, the mount will slew to the target. When the slew has successfully completed, *ServoCAT*<sup>™</sup> sends a request to ARGO NAVIS<sup>™</sup> to play an up-beat pair of notes. ARGO NAVIS<sup>™</sup> then continuously sends tracking rate data to the *ServoCAT*<sup>™</sup> and the mount will follow the target.

If for any reason you want to perform an emergency stop during a slew, simply press any three buttons on the *ServoCAT*<sup>™</sup> hand controller.

### SmartTrack<sup>™</sup>

ARGO NAVIS<sup>™</sup> firmware version 3.0.0 and later and *ServoCAT*<sup>™</sup> firmware version 7.0.A and later support a feature called SmartTrack<sup>™</sup>.

SmartTrack<sup>™</sup> provides tracking rates inherent to the target when you are tracking solar system objects.

Solar system objects include the planets, Sun, Moon, asteroids, comets and artificial satellites. Tracking of near-Earth asteroids or comets (NEOs) as they pass very close to Earth, for example between the Earth and the Moon, is not supported.

To enable SmartTrack<sup>™</sup>, dial up the solar system object you wish to observe from within [MODE CATALOG](#), [MODE IDENTIFY](#) or [MODE TOUR](#). Ensure that the lower line of the display shows the word GUIDE or that you are within a sub-menu beneath guide mode.



SmartTrack™ then provides tracking rates inherent to the target object when you are within 5° radius of a satellite or 2.5° radius of any other type of solar system object.

SmartTrack™ reverts back to the sidereal rate inherent to the point in the sky you are observing whenever the target object is not a solar-system object, or in the case it is a solar system object, whenever the menu is no longer in GUIDE mode or one of the submenus beneath it, or whenever the satellite is outside of the 5° radius or any other type of solar system object is outside the 2.5° radius.

In other words, what SmartTrack™ tries to do is provide you with a tracking rate that is appropriate for what you are observing.

If for example you have the MOON dialled up on ARGO NAVIS™ and are tracking the Moon, SmartTrack™ will guide the scope at lunar rates. If you then grab the *ServoCAT*™ hand controller and slew well away from the Moon, beyond the 2.5 degree radius, SmartTrack™ assumes you are manually cruising the area and so it reverts back to the sidereal rate.

### Tracking artificial satellites

When attempting to track artificial satellites with ARGO NAVIS™ and *ServoCAT*™ the following tips can be useful.

- Timing can be critical. The section “[Setting the date/time from your PC to ARGO NAVIS™](#)” describes how to install a [Network Time Protocol \(NTP\)](#) client on your PC and then how to use the [ARGONAUT™ Set Date/Time feature](#). The section “[Scaling the ARGO NAVIS™ time-of-day clock](#)” describes how to use ARGONAUT™ to compute and apply a simple linear model that can further improve time-keeping.
- Set your latitude and longitude in [SETUP LOCATION](#) accurately.
- Set your [SETUP GOTO](#), GOTO LIMITS values to suitable values for your mount.
- Ensure [SETUP REFRACTION](#) is ON.
- Set [SETUP GUIDE MODE](#), GUIDE BELOW HORZ, H INDICATOR ON. You will be able to determine at a glance whether a candidate satellite is above or below the horizon.
- Ensure you have the [latest orbital elements](#).
- Use [heavens-above.com](#) to determine what satellites may be visible from your location at the time which you wish to observe. Generally low Earth orbit satellites are only visible just after sunset and just before sunrise as otherwise they are eclipsed by Earth’s shadow. Geostationary satellites, in their very high orbits of 32,786km, are out of Earth’s shadow for even longer periods and can often be observed late at night.
- Perform an accurate alignment.
- Consider using [TPAS](#) to improve your mount’s whole sky pointing.



- If you have loaded the orbital elements of more than one satellite, there are several ways one can seek out a potentially observable candidate. One way is to use [MODE IDENTIFY](#) with an object filter selection of SATELLITE, a magnitude selection filter of ANY, a constellation filter selection of IN ANY CONSTEL, a “within” filter selection of WITHIN 360° ARC and a HORIZON MASK filter set to 0 or larger. Leave [MODE IDENTIFY](#) in the mode where it is continually searching. Initially the display might show NO MATCH FOUND. However, as soon as a satellite rises above the value specified by the HORIZON MASK, one can then spin the dial one detent click or press **ENTER** to lock onto it and then press the GOTO button.
- Alternatively, use the special feature of [MODE CATALOG](#) which enables you to step through the catalog by spinning the dial while in GUIDE mode. While stepping through each object, take note of the presence or absence of the H horizon indicator on the far-right of the lower line of the display. The H indicates that the object is currently below the horizon. If you dial up a satellite that is below the horizon, ARGO NAVIS™ will emit down-beat tones. Whenever you see a candidate satellite where the H indicator is not present, ARGO NAVIS™ will emit up-beat tones and pressing GOTO will slew to the target.
- If using [MODE CATALOG](#) in the way just described, one strategy is to leave the telescope waiting at the LOW limit. Examine the ALT GUIDE value to try and get some sense as to whether the satellite might be about to rise. If the satellite rises above the horizon and the specified LOW limit, ARGO NAVIS™ will emit up-beat tones. If you press GOTO and the satellite is within 5° radius, SmartTrack™ automatically turns on and the *ServoCAT*’s™ AutoLOCK™ feature will then track it.
- As long as the satellite remains in the 5° radius lock range it will continue to be tracked, unless the satellite speed gets to be too high, in which case if it falls out of range, *ServoCAT*™ requests ARGO NAVIS™ to emit a double-beep to warn you. The satellite speed may become too high if the satellite happens to pass overhead through the pole of the scope. Once the satellite has peaked and is descending in altitude, you can regain lock by hitting the GOTO button once again.
- Initially use the eyepiece with the widest field of view (FOV) you have available to locate the satellite. If you would like to observe the satellite with higher power, have those eyepieces ready to go so you can change over quickly.
- Be aware that some satellites are fast moving and hence the scope can track quickly. We don’t recommend you track a satellite on a scope that requires a ladder. However, if you do, be very careful if observing from atop a ladder as the telescope hitting you or the ladder could result in injury and damage.
- There is a limit to how fast a satellite can be tracked. For example, if a satellite goes straight up and should pass through the pole of the mount, at the instant it crosses the pole the mount would need to rotate at an infinite speed in azimuth in



ARGO NAVIS™

order to keep tracking it. The *ServoCAT*<sup>™</sup> can be configured to track fast but not infinitely fast.

- Mount fabrication errors, timing errors or errors within the orbital elements themselves can conspire to put the satellite not quite where *ARGO NAVIS*<sup>™</sup> computes it should be. Use the *ServoCAT*<sup>™</sup> hand controller Guide buttons in conjunction with an eyepiece with a wide FOV to locate the satellite if need be. Also use the *ServoCAT*<sup>™</sup> hand controller sliding Guide-fast/Guide slow switch to change the manual guide speed if required. These manual guide rates are scaled based on the satellites actual rate on each of the two axes. SmartTrack<sup>™</sup> has a special feature that when you move around the field using the *ServoCAT*<sup>™</sup> hand controller you automatically change where the 'center point' lock is. When you stop pressing the Guide buttons, within 1 second it will re-establish *that* point as the "lock point". By making adjustments in this way with the Guide buttons, you can center the target and lock onto it.
- If you have used the *ServoCAT*<sup>™</sup> hand controller Guide buttons and want to go back to the *ARGO NAVIS*<sup>™</sup> computed position, simply press GOTO again. Note that if you were off by some distance it will take a few seconds to get back to the computed location.
- When a satellite you are tracking goes beneath the [SETUP GOTO](#), GOTO LIMITS LOW limit or beneath the horizon, the mount will continue to track in azimuth but will stop in altitude. Be aware that the tracking rate in azimuth may then become very high. To stop this track rate, press **EXIT** on *ARGO NAVIS*<sup>™</sup> which will then cancel SmartTrack<sup>™</sup> satellite tracking.
- Geostationary satellites are in high 32,786km orbits above the Earth's equator. *ARGO NAVIS*<sup>™</sup> will also compute their tracking rates which are effectively zero. Thus the *ServoCAT*<sup>™</sup> will not move at all whilst observing them. When you observe these objects in the eyepiece it is fascinating to watch the background stars move across the FOV whilst the satellite remains stationary.



## Programmer's reference

The ARGO NAVIS™ provides two [serial ports](#), each of which runs a command interpreter program called the “shell”. This section lists the available commands in alphabetical order, which provides for a handy reference for programmers wanting to write software to interface with ARGO NAVIS™.

In the Windows™ environment, developers can experiment with the various shell commands by typing into the [Terminal](#) window of the supplied [ARGONAUT™](#) utility. The shell should be put into the ‘navis’ startup command state to do this. (See [SETUP SERIAL](#)).

When the shell starts it sends out a command prompt consisting of a percent sign followed by a space. i.e.

%\_ (where \_ represents a space)

The following is true except once the [meade](#), [pbt](#), [servocat](#), [sitech](#), [skycomm](#) and [tangent](#) emulation modes have been entered -

The ARGO NAVIS™ serial port terminal device echo's input characters. Input is line based and is terminated by a newline character ('\n'). All input is 'cooked'. Input on a line can be erased via the backspace character. XON-XOFF handshaking is honoured in both directions. '\n' is echoed as '\r\n'. Output lines are terminated by the same sequence. Backspace is echoed as 'backspace space backspace'.

The shell interprets the input line when it has been terminated with a newline character. The shell accepts white space before and after commands and their arguments. Once a command is completed, the shell re-issues the command prompt.

The [meade](#), [pbt](#), [servocat](#), [sitech](#), [skycomm](#) emulation modes put the ARGO NAVIS™ serial port terminal device into a line discipline that is compatible with the devices being emulated. These commands, along with the [navis](#) command, can all be used as startup commands. (See [SETUP SERIAL](#)).



## asteroid

### Function

The asteroid shell command puts ARGO NAVIS™ into the asteroid orbital element processing state. When the asteroid command is issued, ARGO NAVIS™ will respond with 'OK'

Orbital element files can be [downloaded](#) from the Internet. ARGO NAVIS™ uses the same orbital element format as TheSky™ software package. A short example file follows –

```

1 Ceres      |2002 05 06.000|0.079116 |2.766412| 10.5835| 80.4863 | 73.9844 | 2000|189.2752 | 3.34| 0.12| 0.00
2 Pallas    |2002 05 06.000|0.229937 |2.773483| 34.8425|173.1716 |1310.3944 | 2000|175.4143 | 4.13| 0.11| 0.00
3 Juno      |2002 05 06.000|0.258898 |2.667458| 12.9711|170.1326 |1247.9936 | 2000| 73.8333 | 5.33| 0.32| 0.00
5 Astraea   |2002 05 06.000|0.193003 |2.572864| 5.3695|141.6928 |1357.7118 | 2000|243.8043 | 6.85| 0.15| 0.00
6 Hebe      |2002 05 06.000|0.201452 |2.425562| 14.7667|138.8476 |1238.9243 | 2000|269.4231 | 5.71| 0.24| 0.00
7 Iris      |2002 05 06.000|0.229900 |2.386307| 5.5240|259.8647 |145.2015 | 2000|282.0402 | 5.51| 0.15| 0.00

```

While in the asteroid orbital element processing state, ARGO NAVIS™ processes input a line at a time. A line is terminated by a newline character. A line can either be –

- An empty line, or
- An orbital element entry as above, or
- An asteroid state command

All state commands begin with a '#' character. These state commands are as follows –

- #Quit : Leave the asteroid state and return to the shell
- #Write : Commit all loadable catalog data to FLASH
- #Count : Return a count of how many asteroid elements are currently loaded.
- #Purge : Remove the asteroid catalog from RAM
- #Memory : Report free space in bytes in loadable catalog memory pool
- #Delete <OBJECT NAME> : Delete the specified asteroid from RAM

All input lines, except #Count, #Memory and #Quit commands, will be responded to with either –

- OK
- ERROR: <MESSAGE>



ARGO NAVIS™



## comet

### Function

The comet shell command puts ARGO NAVIS™ into the comet orbital element processing state. When the comet command is issued, ARGO NAVIS™ will respond with 'OK'

Orbital element files can be [downloaded](#) from the Internet. ARGO NAVIS™ uses the same orbital element format as TheSky™ software package. An example file follows –

```

22P/Kopff |2000|20021212.0944 | 1.583616 |0.543212 |162.7603 |120.9293 | 4.7185 | 3.0 |26.0 | MPC 34423
86P/Wild 3 |2000|20010618.4822 | 2.309902 |0.364447 |179.1225 | 72.6090 | 15.4380 |11.0 |15.0 | MPC 3166
129P/Shoemaker-Levy 3 |2000|20050603.7287 | 2.810134 |0.249392 |181.4039 |303.6526 | 5.0120 |11.0 |10.0 | MPC 30739
C/2002 C1 (Ikeya-Zhang) |2000|20020318.9811 | 0.507053 |0.990129 | 34.6669 | 93.3696 | 28.1218 | 7.0 |10.0 | MPEC 2002-H23
C/2002 C2 (LINEAR) |2000|20020410.7764 | 3.253938 |1.000000 |159.9244 |242.9541 |104.8846 | 8.5 |10.0 | MPEC 2002-F22
P/2002 CW134 (LINEAR) |2000|20020228.9470 | 1.839612 |0.489434 |190.1120 |348.3179 | 15.2273 |13.0 |10.0 | MPEC 2002-G39
C/2002 E2 (Snyder-Murakami) |2000|20020221.7737 | 1.466270 |1.000115 | 9.0185 |244.5781 | 92.5440 | 7.5 |10.0 | MPEC 2002-J35
C/2002 F1 (Utsunomiya) |2000|20020422.8984 | 0.438299 |0.999556 |125.8999 |289.0295 | 80.8765 | 8.5 |10.0 | MPEC 2002-J10
C/2002 H2 (LINEAR) |2000|20020323.5875 | 1.636079 |1.000000 | 20.5431 |269.0400 |110.5088 |10.5 |10.0 | MPEC 2002-J36
C/2002 J4 (NEAT) |2000|20031001.301 | 3.62793 |1.000000 |230.588 | 70.992 | 46.333 | 5.5 |10.0 | MPEC 2002-J47

```

While in the comet orbital element processing state, ARGO NAVIS™ processes input a line at a time. A line can either be –

- An empty line, or
- An orbital element entry as above, or
- A comet state command

All state commands begin with a '#' character. These state commands are as follows –

- #Quit : Leave the comet state and return to the shell
- #Write : Commit all loadable catalog data to FLASH
- #Count : Return a count of how many comet elements are currently loaded.
- #Purge : Remove the comet catalog from RAM
- #Memory : Report free space in bytes in loadable catalog memory pool
- #Delete <OBJECT> : Delete the specified comet from RAM

All input lines, except #Count, #Memory and #Quit commands, will be responded to with either –

- OK
- ERROR: <MESSAGE>



ARGO NAVIS™

## date

### Function

Return the current date and time.

date accepts the following optional arguments –

- -j : return the current Julian Date.
- -l : return the local date and time.
- -u : return the UTC date and time.
- -z: report time zone offset
- -s Julian Date: set the UTC date and time according to supplied argument
- -f curScale: set the current clock scaling factor to the supplied argument
- -x: report the current clock scaling factor curScale
- -a: perform clock scaling averaging
- -e: report number of ticks since epoch
- -k: make the curScale to be the same as the computed hwScale

date with no arguments returns the local time.

### Examples –

```
% date -j
24557009.67523347 Julian
% date -l
15:13:38 THU 18 DEC 2014 Local
% date -u
04:14:17 THU 18 DEC 2014 UTC
% date
15:14:40 THU 18 DEC 2014 Local
%
```



ARGO NAVIS™

enc

**Function**

Report the azimuth and altitude encoder step positions.

Example –

```
% enc  
+08002 +07764  
%
```



ARGO NAVIS™

## encctl

### Function

Set the encoder TON and TOFF times in a manner analogous to the [SETUP ENC TIMING](#) menu function. However, unlike the [SETUP ENC TIMING](#) menu, the TON and TOFF parameters will not be written to non-volatile memory (EEROM device). Therefore, any change in TON and TOFF timing made by this command will not be persistent once the unit is powered off.

encctl requires two integer arguments, the TON and TOFF times. Both arguments are in the range [0..255]. Except for the special case where TOFF = 0, TOFF should be greater than or equal to TON.

### Example –

```
% encctl 17 17
%
```

## event

### Function

Event takes a single integer as an argument. It will queue and sound an alarm event at the specified number of seconds in the future.

### Example –

```
% event 120  
%
```

Will sound an alarm 120 seconds from the time the command was invoked.



ARGO NAVIS™

fp

**Function**

Send an object entry to the FROM PLANETARIUM catalog entry.

Usage fp `NAME|RA|DEC|OBJECT TYPE|MAGNITUDE|OPTIONAL DESCRIPTION`

The back-quote characters (`) are essential.

Co-ordinates are assumed to be at the J2000.0 Epoch and acceptable formats are identical to those accepted by the User Catalog feature.

Object types are identical to that accepted by the User Catalog feature.

**Example –**

```
% fp `SUPERNOVA|12:34:56|+12:34|STAR|1.0|BRIGHTENING BY THE HOUR`  
%
```



**ARGO NAVIS™**

## meade

### Function

Enter Meade emulation mode. meade can be used as a shell startup command (See [SETUP SERIAL](#)).

A sub-set of the Meade protocol command set is accepted –

ACK (0x06) - report mount type  
:Aa# - start automatic alignment sequence  
:CM# - calibrate mount  
:D# - request distance bars  
:GA# - fetch telescope altitude  
:GC# - fetch local date MM/DD/YY  
:GD# - fetch declination  
:GF# - get find field diameter  
:GG# - get offset from GMT  
:GL# - get local time  
:GM# - get current site name  
:GN# - get current site name  
:GO# - get current site name  
:GP# - get current site name  
:GR# - fetch RA  
:GS# - get sidereal time  
:GT# - get tracking rate in Hertz  
:GVD# - get firmware date  
:GVF# - return Autostar# string  
:GVN# - get firmware number  
:GVP# - get product name  
:GVT# - get firmware time  
:GZ# - fetch telescope zenith  
:Ga# - get current local time in 12 hour format  
:Gb# - get brighter magnitude limit  
:Gc# - report 24 hour clock format  
:Gd# - report current object/target Dec J2000.0 airless  
:Gf# - get faint magnitude limit  
:Gg# - get current longitude  
:Gh# - get high limit  
:Go# - get low limit  
:Gr# - get current object/target RA L2000.0 airless  
:Gt# - get current latitude  
:Li# - get object information



ARGO NAVIS™



:MS# - slew to most recent RA/Dec – fill FROM PLANETARIUM object  
:Me# - command motion east until quit is received  
:Mn# - command motion north until quit is received  
:Ms# - command motion south until quit is received  
:Mw# - command motion west until quit is received  
:P# - high precision toggle  
:Q# - stop motion  
:Qe# - stop motion east  
:Qn# - stop motion north  
:Qs# - stop motion south  
:Qw# - stop motion west  
:SC MM/DD/YY# - set current date  
:SG sHH# - set offset from Greenwich  
:SL HH:MM:SS - set current local time  
:Sd sDD°MM# or Sd sDD°MM:SS - defines commanded declination  
:Sg DDD°MM# or Sg DDD°MM:SS# - set current longitude  
:Sr HH:MM.S# or Sr HH:MM:SS - defines commanded RA  
:St sDD°MM# or St sDD°MM:SS# - set current latitude  
:T+# - increment manual tracking rate by 0.1Hz  
:T-# decrement manual tracking rate by 0.1Hz  
:TM# - select manual tracking rate  
:TQ# - select quartz tracking rate  
:U# - toggle between long and short formats  
:W1# :W2# :W3# :W4# - sets the current site number accordingly  
:X# - exit out of meade mode. This is an ARGO NAVIS™ extension

Keep in mind that some planetarium programs might expect the Baud rate to be [set](#) at 9600 when they are configured to communicate with a Meade scope.

If the planetarium program has an option to transmit the location, switch it off. Whenever the location or date and time is transmitted to ARGO NAVIS™ then it is designed to invalidate the current alignment.



## navis

### Function

navis is a null command. navis can be used as a shell startup command to ensure that the shell remains in native ARGO NAVIS™ mode. (See [SETUP SERIAL](#))



ARGO NAVIS™

## pbt

### Function

Enter pbt mode, which allows for piggybacking an ARGO NAVIS™ to a Tangent™-compatible device, such as an Orion IntelliScope™ controller, NGC-MAX™, Celestron Advanced Astromaster™, the Lumicom Sky Vector™ and the Software Bisque BBox™.

To interface these devices to ARGO NAVIS™, a special serial cable is required that acts as a 'null-modem' device. Contact [Wildcard Innovations](#) for details on how to purchase this cable.

pbt is normally invoked as a startup command (See [SETUP SERIAL](#)). It periodically issues [Tangent™ protocol](#) 'Q' commands to the attached Tangent™ device. This command requests the Tangent™ device to respond with its azimuth and altitude encoder step positions. ARGO NAVIS™ then accepts these encoder positions as if they had come from its own in-built encoder device. Thus, in typical use, the encoders will not be plugged into the ARGO NAVIS™ encoder port but instead ARGO NAVIS™ will receive all its encoder data from the attached serial device.

This therefore allows ARGO NAVIS™ to be used in conjunction with telescopes that have attached legacy Tangent™-compatible devices. The legacy device is then responsible for reading its attached encoders and for transferring this encoder data to ARGO NAVIS™ via the serial interface upon request. The net result is that the full functionality of ARGO NAVIS™, including such powerful features as **TPAS™**, is brought to the legacy telescope system.

The [SETUP ALT STEPS](#) and [SETUP AZ STEPS](#) menus should be configured to have the same encoder step values and encoder direction sense signs as the legacy system. You should align ARGO NAVIS™ as if it had the encoders attached directly to it. There is no requirement to perform a star alignment of the attached legacy device itself, as ARGO NAVIS™ simply reads raw encoder positions rather than RA/Dec co-ordinates from it.

Example –

```
% pbt
```



# ARGO NAVIS™

## rad

### Function

rad returns the Right Ascension and Declination position of the scope.

rad accepts the following optional arguments –

- -d : report co-ordinates in decimal degrees
- -r : report co-ordinates in radians
- -s : report co-ordinates in sexagesimal format

rad with no arguments returns the position in radians.

The output is in fixed format. This includes padding with leading and trailing 0's as need be. Declinations are always signed even for the +00.000000 case. The various formats can be deduced as per the following examples.

### Examples -

```
% rad
0.012873 +0.000000
% rad
1.205068 +0.288230
% rad -r
1.205214 +0.288230
% rad -d
069.0626 +16.5143
% rad -s
04:36:18 +16:30:52
%
```



## samples

### Function

Allow dumping of **TPAS™** pointing data for offline analysis by Wildcard Innovations.

The samples shell command puts **ARGO NAVIS™** into the samples command interpreter state.

When the samples command is issued, **ARGO NAVIS™** will respond with a prompt of 'samples >'

While in the samples command interpreter state, **ARGO NAVIS™** processes input a line at a time. A line can either be –

- An empty line, or
- A samples interpreter command

The samples interpreter commands are as follows –

- output : Dump pointing data in ASCII hex format
- quit : Exit the samples command interpreter state and return to the shell.

For transfer to Wildcard Innovations, all data from the output command, including the START OF DATA and END OF DATA header and footer should be saved to a file.



ARGO NAVIS™

## satellite

### Function

The satellite shell command puts ARGO NAVIS™ into the satellite orbital element processing state. When the satellite command is issued, ARGO NAVIS™ will respond with 'OK'

Orbital element files can be [downloaded](#) from the Internet. ARGO NAVIS™ uses the TLE orbital element format. A short example file follows –

```
ISS (ZARYA)
1 25544U 98067A 02135.48405093 .00042932 00000-0 52692-3 0 4479
2 25544 51.6362 217.3518 0008319 67.3940 105.9317 15.59833453198923
HST
1 20580U 90037B 02135.20522200 .00004651 00000-0 39011-3 0 9856
2 20580 28.4659 50.4208 0003933 194.1220 285.2443 14.96114979460736
OKEAN 0
1 25860U 99039A 02134.69951329 .00001845 00000-0 30159-3 0 9343
2 25860 97.8984 185.6866 0000510 90.8169 269.3102 14.72001125151752
```

While in the satellite orbital element processing state, ARGO NAVIS™ processes input a line at a time. A line can either be –

- An empty line, or
- An orbital element entry as above, or
- A satellite state command

All state commands begin with a '#' character. These state commands are as follows –

- #Quit : Leave the satellite state and return to the shell
- #Write : Commit all loadable catalog data to FLASH
- #Count : Return a count of how many satellite elements are currently loaded.
- #Purge : Remove the satellite catalog from RAM
- #Memory : Report free space in bytes in loadable catalog memory pool
- #Delete <OBJECT> : Delete the specified satellite from RAM

All input lines, except #Count, #Memory and #Quit commands, will be responded to with either –

- OK
- ERROR: <MESSAGE>



ARGO NAVIS™

## servocat

### Function

servocat is an unpublished, proprietary protocol that allows for connection to a StellarCAT *ServoCAT*<sup>™</sup> GOTO controller also running the servocat protocol.

servocat is typically used as a shell startup command (See [SETUP SERIAL](#)).

Note that StellarCAT and Wildcard Innovations recommend that users upgrade the firmware of earlier *ServoCAT*<sup>™</sup> systems to allow use of this protocol. Previously *ServoCAT*<sup>™</sup> users used the skycomm protocol. Contact StellarCAT for details.

When used in conjunction with the features of [SETUP GOTO](#), the servocat protocol offers additional benefits over the [skycomm](#) protocol, such as the ability to send the equivalent of an ARGO NAVIS<sup>™</sup> **ENTER** button press from the *ServoCAT*<sup>™</sup> hand controller during the alignment process, Alt limit checking, horizon checking and audible alarms.

An additional feature of the servocat protocol is SmartTrack<sup>™</sup> which provides for tracking of solar system objects and man-made objects at their inherent tracking rates.

Note that a special serial cable, Part No, pn-cat-cbl, is required for interfacing the *ServoCAT*<sup>™</sup> to the ARGO NAVIS<sup>™</sup>. This serial cable is different to that used to interface ARGO NAVIS<sup>™</sup> to a PC.

The Baud rate of the corresponding serial port should be set to 19200.

The red 'DSC' LED on the front panel of the *ServoCAT*<sup>™</sup> can be used to diagnose successful communications between the two devices. When the LED is flashing, it indicates communication is taking place but that ARGO NAVIS<sup>™</sup> is unaligned. When the LED is steady ON, this indicates that ARGO NAVIS<sup>™</sup> has been aligned.





## setups

### Function

The setups shell command puts ARGO NAVIS™ into the setups command interpreter state. The unit needs to be in the [SETUP LOAD CAT](#) state in order for command processing to take place.

When the setups command is issued and the unit is in the [SETUP LOAD CAT](#) state, ARGO NAVIS™ will respond with 'OK'

While in the setups command processing state, ARGO NAVIS™ processes input a line at a time. A line can either be –

- An empty line, or
- A setups command line

All setups commands begin with a '#' character. These setups commands are as follows –

- #Commit : Commit all setup parameters from RAM to non-volatile memory (EEROM device)
- #Count : Return a count of how many setup parameters exist
- #Quit : Leave the setups state and return to the shell
- #Read : Dump all setup parameters to standard output
- #Read *item\_no* : Dump the setup parameter specified by *item\_no* to standard output
- #Write *|parameter|value|comment* : Write the value for the specified setup parameter to RAM. Comment is optional.
- #Version : Return the current firmware version number

All input lines, except #Count, #Read, #Version and #Quit commands, will be responded to with either –

- OK
- ERROR: <MESSAGE>

When setup parameters are #Read, the returned format is *parameter|value|comment*



## sitech

### Function

sitech is a proprietary protocol that allows for connection to a Sidereal Technology SiTech™ GOTO controller.

sitech is typically used as a shell startup command (See [SETUP SERIAL](#)).

The Baud rate of the corresponding serial port should be set to 19200.

When ARGO NAVIS™ is configured to communicate to a SiTech™ controller using the sitech protocol, it receives its encoder data from the SiTech™ servo encoders via the serial interface. Thus, in this configuration, the encoders are not plugged into the ARGO NAVIS™ encoder port.

The [SETUP ALT STEPS](#) and [SETUP AZ STEPS](#) menus should be configured to have the same encoder step values and encoder direction sense signs as directed by Sidereal Technology. You should align ARGO NAVIS™ as if it had the encoders attached directly to it.

Note that you can also interface ARGO NAVIS™ to the SiTech™ GOTO controller using a shared encoder architecture if you require a closed-loop positioning system. Contact Sidereal Technology for details.



## skycomm

### Function

Enter Sky Commander™ emulation mode. skycomm can be used as a shell startup command (See [SETUP SERIAL](#)).

To interface ARGO NAVIS™ to a Sky Tracker™ GOTO drive system, set the shell startup command on the appropriate serial port to skycomm. Note that *ServoCAT*™ users should upgrade the firmware in their GOTO drive controller system to use the [servocat](#) protocol.

A sub-set of the Sky Commander™ protocol command set is accepted –

Remote system sends \r i.e. carriage return (control m).

Response is RA and Dec in the following format -

\_12.234\_+67.890NULL (where \_ represents space and NULL is null char)

Remote system sends O

Response is Altitude (elevation) and Azimuth offsets to the 'guided' current object in units of degrees. Format is eight raw bytes representing two floating-point values. The floating point representation is Big-Endian with a exponent biased by 128. To convert to industry standard IEEE Floating Point Format, divide the returned values by 4. The first four bytes are the Altitude (elevation) offset where +=Go Up. The next four bytes are the Azimuth offset where +=Go CCW. The current 'guided' object is that object which was most recently selected in GUIDE mode while in [MODE CATALOG](#), [MODE IDENTIFY](#) or [MODE TOUR](#) or was used to perform and alignment on in [MODE ALIGN](#) or [MODE ALIGN STAR](#).

Remote system sends R

Response is the Altitude (elevation) and Azimuth drive rates required to track the celestial sphere at the RA and Dec position that ARGO NAVIS™ determines the telescope is currently pointing to. Units are degrees/minute. Format is eight raw bytes representing two floating-point values. The floating point representation is Big-Endian with a exponent biased by 128. To convert to industry standard IEEE Floating Point Format, divide the returned values by 4. The first four bytes are the Altitude (elevation) drive rate where +=Go Up. The next four bytes are the Azimuth drive rate where +=Go CCW.

Remote system sends q

skycomm mode is exited. This is an ARGO NAVIS™ extension.



ARGO NAVIS™

## tangent

### Function

Enter Tangent™ emulation mode. This is the protocol used by NGC-MAX™, Celestron Advanced Astromaster™, the Lumicom Sky Vector™, Orion and the Software Bisque BBox™.

Tangent can be used as a shell startup command (See [SETUP SERIAL.](#)).

There are two commands -

Remote system sends 'Q'

Response is the fixed format azimuth and altitude encoder step positions normalized as per the Tangent devices. For example –

```
+01234<tab>-00123<\r>
```

Remote system sends 'P'

Response is a three digit status number, where the first digit is the number of altitude encoder errors, the second is the number of azimuth encoder errors and the third is 0 for power level low or 1 for power level OK. For example -

```
001<\r>
```

Note that Tangent devices are not capable of having their current RA and Dec position queried. They only return their raw encoder position.

Keep in mind that some star mapping and planetarium packages might expect the Baud rate to be [set](#) at 9600 when they are configured to communicate with a Tangent device.



## therm

### Function

Report the unit's current internal temperature. Conversion time takes approximately 2 seconds.

therm accepts the following optional argument –

- -f : report the current internal temperature in degrees Fahrenheit.

therm with no arguments returns current internal temperature in degrees Celsius.

### Examples –

```
% therm
```

```
30.1250C
```

```
% therm -f
```

```
86.3375F
```



ARGO NAVIS™

## uptime

### Function

Report how long the unit has been powered on for, in days, hours, minutes and seconds. When the unit is powered off, the uptime returns to zero.

### Example –

```
% uptime  
8:33.05  
%
```

The above example indicates the unit has been powered on for 8 hours, 33 minutes and 5 seconds.



ARGO NAVIS™

## user

### Function

The user shell command puts ARGO NAVIS™ into the user catalog processing state. When the user command is issued, ARGO NAVIS™ will respond with 'OK'

The User catalog format and an example is detailed in [How to create your own User catalog files](#).

While in the user catalog processing state, ARGO NAVIS™ processes input a line at a time. A line can either be –

- An empty line, or
- A User object entry line, or
- A user state command

All state commands begin with a '#' character. These state commands are as follows –

- #Quit : Leave the user state and return to the shell
- #Write : Commit all loadable catalog data to FLASH
- #Count : Return a count of how many User catalog objects are currently loaded.
- #Purge : Remove the User catalog from RAM
- #Memory : Report free space in bytes in loadable catalog memory pool
- #Delete <OBJECT> : Delete the specified User catalog object from RAM

All input lines, except #Count, #Memory and #Quit commands, will be responded to with either –

- OK
- ERROR: <MESSAGE>



ARGO NAVIS™



## Appendix A—Catalogs

- **ASTEROIDS** (assuming your ARGO NAVIS™ has an [asteroid catalog](#) currently loaded)
- **BRIGHT STARS** (a selection of stars to magnitude 6.5, particularly those with well-known historical names, such as BETELEGUSE and those with Bayer Greek alphabet or Flamsteed numbers. Names have constellation abbreviation first, then Bayer or Flamsteed identifier. For example, FOR ZETA for Zeta Fornax. They are ordered this way to make the catalog easier to browse)
- **COMETS** (assuming your ARGO NAVIS™ has a [comet catalog](#) currently loaded)
- **FROM PLANETARIUM** (consists of the single “FROM PLANETARIUM” object. When ARGO NAVIS™ is interfaced via a serial port to an appropriate planetarium program and a GOTO command is issued from that program, the RA/Dec co-ordinates corresponding to that GOTO position and optionally the name of some associated object are transmitted to the “FROM PLANETARIUM” object. This then allows you to GUIDE to the position that was sent from the planetarium program)
- **IC** (non-stellar selections from the Index Catalogue)
- **MESSIER** (the complete Messier Catalogue)
- **MISC BRIGHT NEB** (miscellaneous bright nebulae, such as emission and reflection nebulae, that do not appear in the MESSIER, NGC OR IC catalogs)
- **MISC DARK NEBULA** (miscellaneous dark nebulae)
- **MISC DOUBLE STAR** (miscellaneous double stars that do not appear in the BRIGHT STAR catalog)
- **MISC GALAXIES** (miscellaneous galaxies that do not appear in the MESSIER, NGC or IC catalog, such as ESO, MCG, UGC and Local Group galaxies)
- **MISC GALAXY CLUS** (miscellaneous galaxy clusters such as the Abell and Hickson clusters)
- **MISC GLOBULARS** (miscellaneous globular clusters that do not appear in the MESSIER, NGC or IC catalogs)
- **MISC OPEN CLUST** (miscellaneous open clusters that do not appear in the MESSIER, NGC or IC catalogs)
- **MISC PLANETARIES** (miscellaneous planetary nebulae that do not appear in the MESSIER, NGC or IC catalogs)
- **MISC VARIABLE ST** (miscellaneous variable stars that do not appear in the BRIGHT STAR catalog)
- **NGC** (the complete New General Catalogue, including all non-stellar, stellar and non-existent objects. Also includes ‘letter suffixed’ objects such as NGC 554A and NGC 554B and all objects that are also Messier objects)



- **PLANETS/MOON/SUN** (in our solar system). The detailed description for the Moon includes the current Moon phase and the local date and time of the next forthcoming phases.
- **POPULAR DEEP SKY** (a convenient cross reference to objects in the MESSIER, NGC or IC catalogs that have popular names, such as ANDROMEDA GALAXY, GHOST OF JUPITER and TARANTULA NEBULA)
- **SATELLITES** (artificial earth orbiting satellites - assuming your ARGO NAVIS™ has a [satellite catalog](#) currently loaded)
- **SCRATCH** (see [SETUP SCRATCH](#))
- **USER OBJECTS** (assuming your ARGO NAVIS™ has [user defined objects](#) currently loaded)



ARGO NAVIS™

## Appendix B—Technical specifications

### CPU's

- Motorola 5206e ColdFire™ 40MHz with full 32-bit data paths and internal caches
- PIC16C505 4MHz 8-bit micro controller

### Memory

- 2MB 70ns re-programmable NOR FLASH.
- Firmware, including all catalogs, is user upgradeable via serial port.
- Firmware and catalog upgrades can be downloaded from <http://www.wildcard-innovations.com.au/> for free.
- 512KB 50ns static RAM
- 8Kb non-volatile RAM (EEROM)

### Power

- 4 x AA alkaline, lithium or rechargeable NiMH cells (up to approximately 40 hours of continuous operation with LCD dimmed). Do not use NiCd or regular/heavy-duty zinc-oxide cells.
- DC power jack for external battery power 8V to 16V DC. Supports live insertion and removal without interruption to unit function when internal batteries also installed. Provides LCD heating function. External power cable optional. Use 350mA fuse.
- AA cells. MODE ALIGN. 58.6mA @ 5.7V, LCD 1%, no encoders. 70mA @ 5.7V, LCD 1%, Encoder Timing

TON=17 TOFF=174, low-resolution encoders. 107mA @ 5.7V, LCD 1% Encoder Timing TON=2 TOFF=10, high-resolution encoders.

- AA cells. MODE IDENTIFY. 140mA @ 5.7V, LCD 1%, Encoder Timing TON=2 TOFF=10, high-resolution encoders.
- External DC. MODE IDENTIFY. 155mA @ 12.3V, LCD 1%, Encoder Timing TON=2 TOFF=10, high-resolution encoders. 200mA @ 12.3V, LCD 100%, Encoder Timing TON=2 TOFF=10 high resolution encoders, LCD heater on.

### Front Panel

- Two buttons and a rotary dial with detents.
- 2x16 character extended temperature supertwist Liquid Crystal Display (LCD).
- Red backlit characters on dark background to preserve night vision.
- Digitally dimmable with 100 settings.
- Digitally adjustable contrast control.
- Dew/LCD heater.

### Encoder port

- 8 pin RJ receptacle to interface with standard TTL quadrature optical encoders.
- Adjustable encoder sampling rates for power saving.
- Max. encoder steps 99,999
- Max. sampling rate 16,000 samples/sec per encoder.



ARGO NAVIS™

- Encoder cable optional.

#### **Displayed resolution**

- Up to 0.01 degrees (36 arc seconds) in GUIDE mode

#### **Communications ports**

- Dual 4 pin RJ receptacles for two RS-232 channels supporting user definable speeds from 300 to 57600 Baud. 1 start bit, 8 data bits, no parity, 1 stop bit.
- Can be interfaced with a PC/Mac/WiFi adapter/Bluetooth adapter and supports use with software such as Sky Safari™, Star Atlas:PRO™, The Sky™, SkyMap Pro™ and Xephem™ for telescope cursor control. Meade™, Sky Commander™ Tangent™ and ARGO NAVIS™ native command mode. Can also be interfaced to GOTO controller such as StellarCAT ServoCAT™.
- Serial communications cables available as option.
- USB Serial Adaptors available as option.

#### **Clock**

- Real time clock with separate 3V lithium coin cell backup battery. Date, time valid to year 2100 AD.

#### **Storage temperature**

- -20°C to 60°C (-4°F to 140°F) ambient

#### **Operating temperature**

- 0°C to 50°C (32°F to 122°F) ambient when using internal battery with no heater.
- -10°C to 40°C (14°F to 104°F) ambient when using external DC power with heater.

#### **Enclosure**

- ABS plastic.
- Dew resistant but not water proof.
- Secure, thumbscrew fastened battery compartment lid.

#### **Dimensions**

195mm (L) x 101mm (W) x 50mm (H)  
7.7" (L) x 4.0" (W) x 2.0" (H)

#### **Weight**

- 336g (11.85 oz) without batteries.
- 433g (15.27 oz) with 4x AA cells

#### **Manufacturing**

Manufactured in Australia under ISO9001 quality control standards.

#### **Certification**

- Meets FCC Class B Part 15
- Meets CE EN5022 Class B, EN5024, EN6100-4-2, EN6100-4-3
- Meets C-Tick AS/NZS 3548 Class B, AS/NZS 61000-4-3

#### **Warranty & disclaimer**

Limited 1 year.

#### **Disclaimer**

Specifications are subject to change without notice.



ARGO NAVIS™

## Appendix C—Port pin descriptions

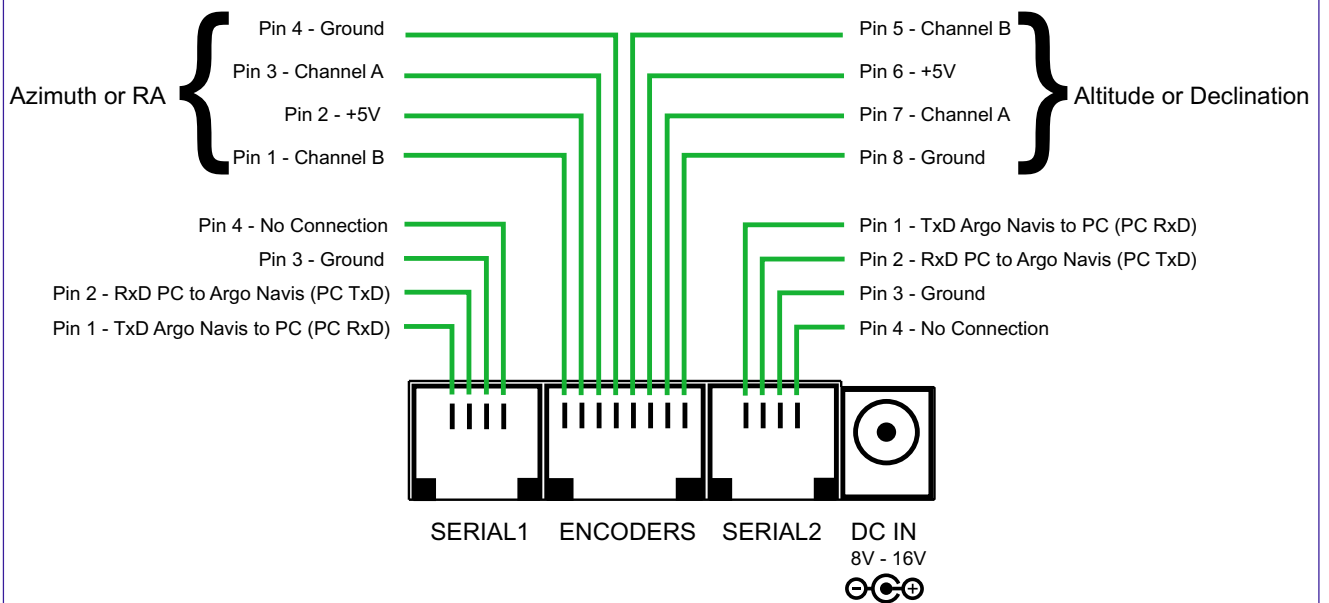

**Figure 13**

## Appendix D—Factors that affect pointing accuracy

You may find that despite following all the alignment procedures that you still can't 'zero-in' on objects. This section discusses some of the factors that affect pointing accuracy.

All telescopes move on two axes. These are the Azimuth (or RA) and Altitude (or Dec) axes. These axes must be at right angles to each other. When the axes are perfectly at right angles, they are said to be "orthogonal". When ARGO NAVIS™ computes positions, it assumes that the axes are orthogonal. If they are not, then the scope will be pointing to a different part of the sky compared to where ARGO NAVIS™ computes that it is pointing. See [SETUP MNT ERRORS](#) for a method of compensating for a lack of orthogonality when the actual error angle is known.

The scope's Optical axis should also be orthogonal to its Altitude (or Dec) axis. Again, see [SETUP MNT ERRORS](#) for a method of compensating for this when the actual error angle is known.

Tube flexure can result in a vertical pointing shift as the tube bends under its own weight. This includes trusses that bend on Dobsonians, particularly if their "top-ends" are heavily laden.

Fork mounts can experience flexure in the forks themselves.

Dobsonian scopes can exhibit a 'wobble' in their azimuth axis, particularly

if the rocker box can tilt side to side with respect to the ground-board.

Imperfectly shaped bearings can create a shift in the pointing direction. For example, the altitude bearings on some Dobsonians can cause the scope to move up and down and side to side in the cradle.

The optical encoders have a finite resolution. For example, 10,000-step encoders have a resolution of 2.16 arc minutes per step.

If the encoders are geared, then gear backlash and periodic errors might come into play.

The precision by which the FIX ALT REF step can be performed in a two star alignment is critical to pointing accuracy. Even if AUTO ADJUST ON is set, the errors already discussed above can compound the error in ascertaining the "zero degree point".

However, ARGO NAVIS™ has a powerful, in-built feature known as **TPAS™** that can assist with many of the above problems.

Additional information, both introductory and advanced, that discusses many of the causes of pointing errors and how to diagnose them, including the use of **TPAS™**, can be found in the [SETUP MNT ERRORS](#) section of this Manual.



ARGO NAVIS™

## Appendix E—Factors that affect encoder direction senses

Whether the direction sense of an encoder is '+' or '-' is dependent upon a number of factors. This section outlines those factors.

1. Encoder on Azimuth (Right Ascension) or Altitude (Declination) axis. By convention, the direction sense of one is interpreted as the opposite to the other.
2. Encoder shaft inward or outward facing. The encoder shaft can either be facing inwards towards the scope or outwards away from it.
3. Altitude encoder on left bearing or right bearing.
4. Encoder geared even or odd number of times.
5. Encoder shaft rotates or encoder body rotates while shaft stationary. For example, on most Fork-mounted scopes the Altitude encoder shaft rotates whilst the body remains stationary whereas the Azimuth encoder body rotates while its shaft remains stationary.
6. Encoder A-B Channel wiring swapped. Quadrature encoders have an A-Channel and a B-Channel. If the Channel wiring is swapped, the direction sense is reversed.
7. Encoder direction sense in SETUP AZ STEPS and SETUP ALT STEPS. Changing the sign in these menus changes the direction sense of the associated encoder.
8. Northern or Southern Hemisphere. Southern Hemisphere operation results in apparent direction sense reversal for both encoders compared to the Northern Hemisphere.



ARGO NAVIS™



## Appendix F—How to replace the lithium coin cell battery

ARGO NAVIS™ uses a 3V lithium coin cell to maintain power to the real-time clock (RTC). This clock maintains the date and time even when the unit is switched off.

Ordinarily the battery should operate for several years. Whenever it goes flat, you will see the following message at power on –

**RTC BATTERY FLAT**

followed by -

**DATE SET TO  
1/1/2000 12:00**

Replace with Panasonic CR-1220 3V or equivalent. Replacements can be ordered from [Wildcard Innovations](http://WildcardInnovations.com).

You need to perform the replacement at a static-free work-station and you need to wear a grounded wrist-strap. Observe all static electricity handling precautions. The sensitive electronic components can be damaged otherwise and you will void your warranty. If you do not have access to these facilities, seek the services of a good electronics technician.

The replacement procedure for the coin cell battery is dependent upon what style casing your ARGO NAVIS™ has. The newer Model 102B case is deep-blue in color and has a compliance plate on the AA cell battery hatch identifying it as a Model 102B. The earlier Model 102 case

is black in color and has a compliance plate beneath the communications ports identifying it as a Model 102.

### Model 102B Coin Cell Replacement

The following outlines the procedure for replacing the coin cell battery on the newer Model 102B.

Referring to Figure 14, remove the coin cell hatch screw and hatch.

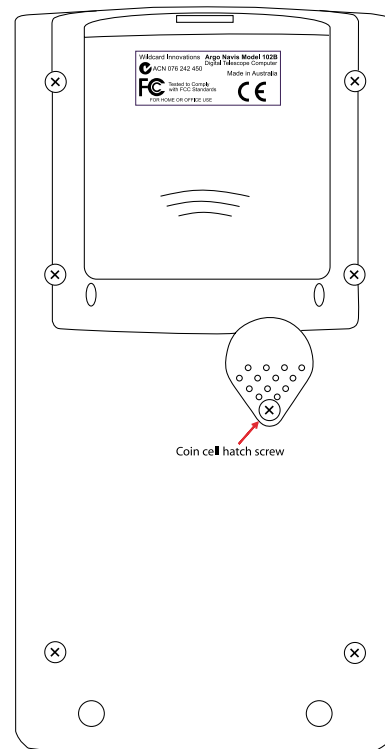

**Figure 14 (ARGO NAVIS™ Model 102B shown)**

Do not touch any of the internal electronic parts or circuit board or you could damage them.

Now identify the coin cell battery holder. Using a small, flat-bladed screwdriver, gently lift the clip, near the end that sits on the coin-cell, by a height of approximately 1mm (1/24"). Simultaneously, use another small flat bladed screwdriver to nudge the coin cell out of the holder. Discard it.

Now that the old coin-cell is removed, gently depress the clip a little with the flat-bladed screwdriver to ensure that it will maintain a tight spring-fit when the new coin cell is inserted.

Remove the new coin cell from its packaging but do not touch the terminals with your fingers. If you do so, clean them with a clean cloth. While holding the coin cell with a clean cloth or clean cotton gloves, gently insert it with the + side up under the clip. Power on the unit and observe the battery flat message should appear once again. Now power it off and power it on again. The battery flat message should now not appear. Otherwise remove the coin cell and check that the clip is tight.

### Model 102 Coin Cell Replacement

The following outlines the procedure for replacing the coin cell battery on the earlier Model 102.

To replace the battery refer to Figure 15.

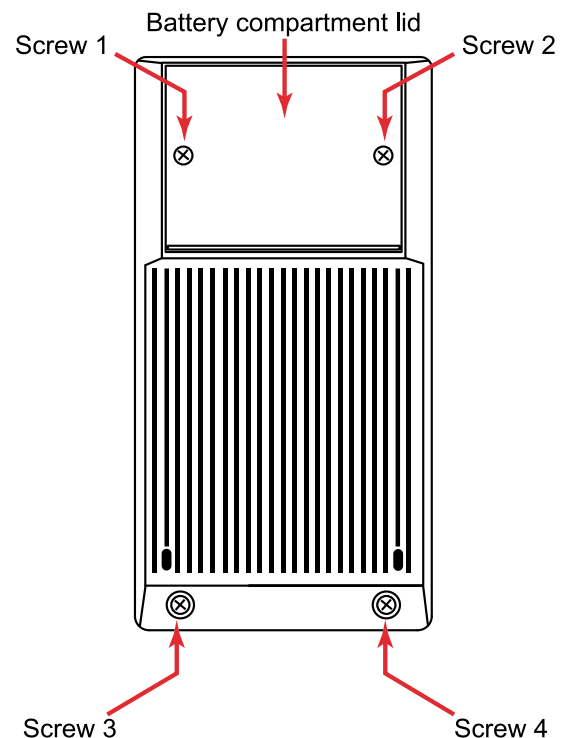

**Figure 15 (ARGO NAVIS™ Model 102 shown)**

Remove the two Philips head screws on the battery housing cover (the raised section at the top of the back) of the ARGO NAVIS™. Also remove the two screws at the bottom of the back of the ARGO NAVIS™. Gently lift the bottom of the battery cover and pry the cover off.

Now refer to Figure 16.

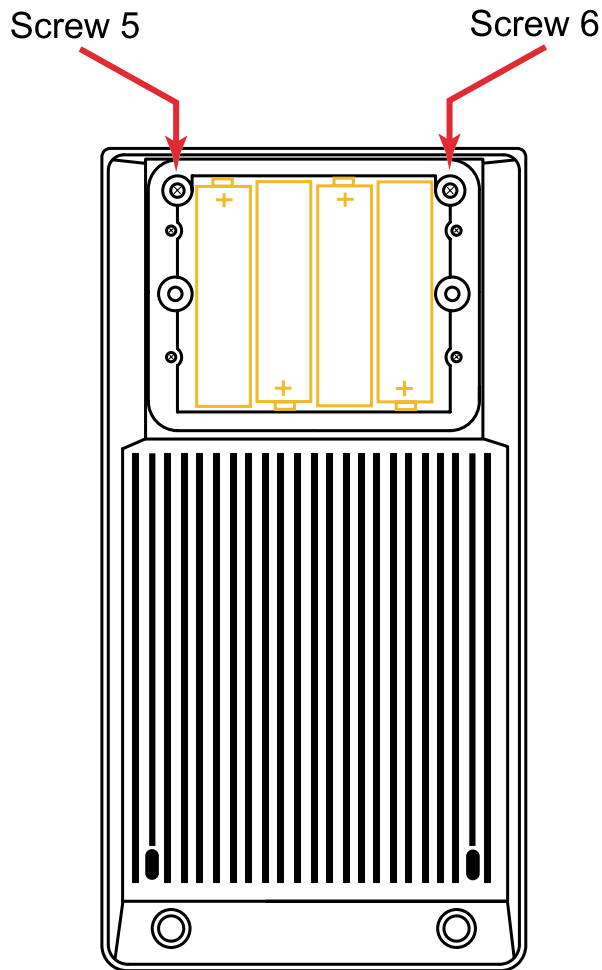

**Figure 16 (ARGO NAVIS™ Model 102 shown)**

Remove the two screws indicated. Do not remove any other screws. Now using both hands, very gently pull the upper half of the casing away from the lower half, being careful not to stretch the internal battery leads that still join the two halves together.

Gently place the upper half face down on a static-free work bench. Place the lower half, with its battery compartment side facing down, just to the right of it. The flying battery leads should just be long enough to allow you to do this.

Do not touch any of the internal electronic parts or circuit board or you could damage them.

Now identify the coin cell battery holder. Using a small, flat-bladed screwdriver, gently lift the clip, near the end that sits on the coin-cell, by a height of approximately 1mm (1/24"). Simultaneously, use another small flat bladed screwdriver to nudge the coin cell out of the holder. Discard it.

Now that the old coin-cell is removed, gently depress the clip a little with the flat-bladed screwdriver to ensure that it will maintain a tight spring-fit when the new coin cell is inserted.

Remove the new coin cell from its packaging but do not touch the terminals with your fingers. If you do so, clean them with a clean cloth. While holding the coin cell with a clean cloth or clean cotton gloves, gently insert it with the + side up under the clip. Power on the unit and observe the battery flat message should appear once again. Now power it off and power it on again. The battery flat message should now not appear. Otherwise, remove the coin cell and check that the clip is tight.

Put the two halves of the unit back together and re-insert all screws.

## Appendix G—Troubleshooting guide

This section forms a checklist to help you find causes and solutions to possible problems.

### Low battery

#### Symptoms

Some signs that the power source might be low include the following -

- The unit fails to power on.
- The unit powers on and shows a **SOURCE=BAT LOW** message during initialization.
- In MODE STATUS, STATUS POWER, the **SOURCE=BAT LOW** or **SOURCE=EXT LOW** message appears.
- The unit powers on, but then keeps showing the **INITIALIZING...** message again and again.
- The unit powers on, seems to run for a short while, then the display goes blank.
- The unit powers on but the display goes blank when the encoders are connected.
- Encoder error messages begin to appear more regularly.
- The unit behaves erratically.

#### Suggestion

Replace the batteries with fresh alkaline ones or check the external power source and external power lead.

Nickel-cadmium batteries and zinc-carbon batteries are not well suited because of their large voltage drops under load.

### Mechanical slippage

#### Symptoms

- While observing the [MODE ENCODER](#) readout, an encoder appears to 'lose' steps when it is turned back and forth in its bearing.
- While observing the [MODE ENCODER](#) readout, one encoder does not register moving.

#### Suggestion

Ensure that the set-screws are tight on the encoder shafts.

Check whether any gear or pulleys are slack.

On Dobsonians, check whether the pivot-bolt in the base of the scope is rotating.

Sight distant stationary objects when checking for mechanical slippage. Since stars appear to constantly move, they are not suitable objects to aid in the checking of mechanical slippage.

Additional information, both introductory and advanced, that discusses many of the causes of pointing errors and how to diagnose them, including the use of the powerful **TPAS™** feature, can be found in the [SETUP MNT ERRORS](#) section of this Manual.

### Encoder cable swapped

#### Symptoms

- When the scope is moved in azimuth the altitude reading in [MODE ENCODER](#) changes and vice versa.

#### Suggestion

Swap the cable connections between the azimuth and altitude encoders. Wildcard Innovations encoder cables have a white sleeve marking the altitude encoder connection.

### Encoder jack upside-down

#### Symptoms

- While observing the [MODE ENCODER](#) readout, one encoder does not register moving.

#### Suggestion

Check whether the flat 5-pin jack has been inserted upside-down into the encoder. Wildcard Innovations encoder cables have a white dot on the 5-pin jack that should match a white dot on top of the encoder.

### Incorrect encoder resolution setting

#### Symptoms

- WARP numbers always high, particularly when [AUTO ADJUST OFF](#) is set.
- Objects cannot be found.
- Poor pointing accuracy.

#### Suggestion

Check the resolution settings of your encoders in [SETUP ALT STEPS](#) and [SETUP AZ STEPS](#).

### Incorrect encoder direction senses

#### Symptoms

- After performing a star alignment, the [MODE RA DEC](#) reading shows the RA value decreasing as the scope is moved toward the East.
- When you guide back to one of the alignment stars, it will not centre in the eyepiece and only seems to get worse with time.
- After performing a star alignment, the [MODE RA DEC](#) reading shows the Dec value decreasing as the scope is moved toward the North.

#### Suggestion

Re-perform the initial set-up procedure to determine the correct direction senses and then set them in [SETUP ALT STEPS](#) and [SETUP AZ STEPS](#).

### Incorrect encoder timing setting

#### Symptoms

- Frequent encoder error messages are displayed when the telescope is slewed.

#### Suggestion

Review the section on [SETUP ENC TIMING](#). If the TON and TOFF values seem reasonable for the types of encoders you have and yet encoder error messages still result, experiment by setting TON to any non-zero value and TOFF to 0. This will cause the encoders to never switch off. If encoder error messages still result, the problem might be an encoder cable fault or a problem with one or more encoders themselves.



Keep in mind that it is possible to exceed the encoder sampling rate if, for example, the encoders are held freely in the hand and their shafts rotated quickly with the fingers. Alternatively, if the encoders are mounted on a scope but have been geared to produce a much higher resolution, the user should be careful not to exceed the sampling rate. See the section on [MODE ENCODER](#) for a discussion of the sampling rate and how to calculate the maximum slew rate for your setup.

### **RA and Dec values seem to change simultaneously when scope is moved in one axis**

#### **Symptoms**

- After performing a star alignment, you examine the readout in [MODE RA DEC](#) and see that when you move the scope only in one axis, both RA and Dec values appear to change.

#### **Suggestion**

If your mount is only roughly polar-aligned or is of the Az/Alt type such as a Dobsonian, this is not a problem at all. When such scopes move only in one axis at a time, both RA and Dec values should change simultaneously. This is because the axis of rotation of your mount does not match the axis of rotation of the sky. Only exactly aligned polar mounts have this attribute.



## Appendix H—How ARGO NAVIS orders its symbols

The *Intelligent Editing System*<sup>™</sup> allows you to rapidly enter the name of an object by spinning the **DIAL** and pressing the **ENTER** button. This table indicates whether a symbol is regarded as alphabetically before or after another.

SPACE	A	W	m
,	B	X	n
-	C	Y	o
.	D	Z	p
/	E	[	q
0	F	\	r
1	G	]	s
2	H	^	t
3	I	_	u
4	J	`	v
5	K	a	w
6	L	b	x
7	M	c	y
8	N	d	z
9	O	e	{
:	P	f	
;	Q	g	}
<	R	h	~
=	S	i	α
>	T	j	β
?	U	k	Σ
@	V	l	

The table goes from top to bottom, left to right. For example, note how lowercase 'a' is regarded as alphabetically after upper case 'Z'. It is a good idea to be consistent in your choice of case when entering your own user object names.





## Appendix I—World time zones

The following list is sorted alphabetically by country. It provides the local time zone including when Daylight Saving (Local summer time) is in effect –

### A

Afghanistan: +4.5 hours  
Albania: +1 hours (Summer +2 hours)  
Algeria: +1 hours (Summer +2 hours)  
American Samoa: -11 hours  
Andorra: +1 hours (Summer +2 hours)  
Angola: +1 hours  
Anguilla: -4 hours  
Antarctica: -2 hours (Summer -3 hours)  
Antigua: -4 hours  
Argentina: -3 hours  
Argentina western provinces: -4 hours  
Armenia: +4 hours (Summer +5 hours)  
Aruba: -4 hours  
Ascension: 0 hours  
Australia Northern Territory: +9.5 hours  
Australia Lord Howe Island: +10:30 hours (Summer +11 hours)  
Australia New South Wales: +10 hours (Summer +11 hours)  
Australia Queensland: +10 hours  
Australia Victoria: +10 hours (Summer +11 hours)  
Australia Australian Capital Territory: +10 hours (Summer +11 hours)  
Australia South: +9:30 hours (Summer +10:30 hours)  
Australia Tasmania: +10 hours (Summer +11 hours)  
Australia Western: +8 hours  
Austria: +1 hours (Summer +2 hours)  
Azerbaijan: +3 hours  
Azores: -1 hours (Summer 0 hours)

### B

Bahamas: -5 hours (Summer -4 hours)  
Bahrain: +3 hours  
Bangladesh: +6 hours  
Barbados: -4 hours  
Belarus: +2 hours (Summer +3 hours)  
Belgium: +1 hours (Summer +2 hours)  
Belize: -6 hours



ARGO NAVIS™

Benin: +1 hours  
Bermuda: -4 hours (Summer -3 hours)  
Bhutan: +6 hours  
Bolivia: -4 hours  
Bonaire: -4 hours  
Botswana: +2 hours.65  
Brazil Acre: -4 hours (Summer -5 hours)  
Brazil Atlantic Islands: -1 hours (Summer -2 hours)  
Brazil East: -3 hours (Summer -1 hours)  
Brazil West: -4 hours (Summer -3 hours)  
British Virgin Islands: -4 hours  
Brunei: +8 hours  
Bulgaria: +2 hours (Summer +3 hours)  
Burkina Faso: 0 hours  
Burundi: +2 hours

## C

Cambodia: +7 hours  
Cameroon: +1 hours  
Canada Central: -6 hours (Summer -5 hours)  
Canada Eastern: -5 hours (Summer -4 hours)  
Canada Mountain: -7 hours (Summer -6 hours)  
Canada Yukon & Pacific: -8 hours (Summer -7 hours)  
Canada Atlantic: -4 hours (Summer -3 hours)  
Canada Newfoundland: -3:30 hours (Summer -2:30 hours)  
Canary Islands: 0 hours (Summer +1 hours)  
Canton Enderbury Islands: -11 hours  
Cape Verde: -1 hours  
Caroline Island: +11 hours  
Cayman Islands: -5 hours  
Central African Rep: +1 hours  
Chad: +1 hours  
Channel Islands: 0 hours (Summer +1 hours)  
Chatham Island: +12:45 hours (Summer +13:45 hours)  
Chile: -4 hours (Summer -3 hours)  
China People's Rep: +8 hours  
Christmas Islands: -10 hours  
Cocos (Keeling) Islands: +6:30 hours  
Colombia: -5 hours  
Congo: +1 hours  
Cook Islands: -10 hours  
Costa Rica: -6 hours  
Cote d'Ivoire: 0 hours  
Croatia: +1 hours (Summer +2 hours)



ARGO NAVIS™

Cuba: -5 hours (Summer -4 hours)  
Curacao: -4 hours  
Cyprus: +2 hours (Summer +3 hours)  
Czech Republic: +1 hours (Summer +2 hours)

## **D**

Dahomey: +1 hours  
Denmark: +1 hours (Summer +2 hours)  
Djibouti: +3 hours  
Dominica: -4 hours  
Dominican Republic: -4 hours

## **E**

Easter Island: -6 hours (Summer -5 hours)  
Ecuador: -5 hours  
Egypt: +2 hours (Summer +3 hours)  
El Salvador: -6 hours  
England: 0 hours (Summer +1 hours)  
Equatorial Guinea: +1 hours  
Eritrea: +3 hours  
Estonia: +2 hours (Summer +3 hours)  
Ethiopia: +3 hours

## **F**

Falkland Islands: -4 hours (Summer -3 hours)  
Faroe Island: 0 hours (Summer +1 hours)  
Fiji: +12 hours  
Finland: +2 hours (Summer +3 hours)  
France: +1 hours (Summer +2 hours)  
French Guiana: -3 hours  
French Polynesia: -10 hours

## **G**

Gabon: +1 hours  
Galapagos Islands: -5 hours  
Gambia: 0 hours  
Gambier Island: -9 hours  
Georgia: +4 hours  
Germany: +1 hours (Summer +2 hours)  
Ghana: 0 hours  
Gibraltar: +1 hours (Summer +2 hours)  
Greece: +2 hours (Summer +3 hours)  
Greenland: -3 hours (Summer -2 hours)  
Greenland Thule: -4 hours (Summer -3 hours)  
Greenland Scoresbysun: -1 hours (Summer 0 hours)



**ARGO NAVIS™**

Grenada: -4 hours  
Grenadines: -4 hours  
Guadeloupe: -4 hours  
Guam: +10 hours  
Guatemala: -6 hours  
Guinea: 0 hours  
Guinea Bissau: 0 hours  
Guyana: -3 hours

## **H**

Haiti: -5 hours (Summer -4 hours)  
Honduras: -6 hours  
Hong Kong: +8 hours  
Hungary: +1 hours (Summer +2 hours)

## **I**

Iceland: 0 hours  
India: +5:30 hours  
Indonesia Central: +8 hours  
Indonesia East: +9 hours  
Indonesia West: +7 hours  
Iran: +3:30 hours  
Iraq: +3 hours (Summer +4 hours)  
Ireland Republic of: 0 hours (Summer +1 hours)  
Israel: +2 hours (Summer +3 hours)  
Italy: +1 hours (Summer +2 hours)

## **J**

Jamaica: -5 hours  
Japan: +9 hours  
Johnston Island: -10 hours  
Jordan: +2 hours (Summer +3 hours)

## **K**

Kazakhstan: +6 hours (Summer +7 hours)  
Kenya: +3 hours  
Kiribati: +12 hours  
Korea Dem Republic of: +9 hours  
Korea Republic of: +9 hours  
Kusaie: +12 hours  
Kuwait: +3 hours  
Kwajalein: -12 hours  
Kyrgyzstan: +5 hours (Summer +6 hours)

## **L**



**ARGO NAVIS™**

Laos: +7 hours  
Latvia: +2 hours (Summer +3 hours)  
Lebanon: +2 hours (Summer +3 hours)  
Leeward Islands: -4 hours  
Lesotho: +2 hours  
Liberia: 0 hours  
Libya: +2 hours  
Lithuania: +2 hours (Summer +3 hours)  
Luxembourg: +1 hours (Summer +2 hours)

## **M**

Macedonia: +1 hours (Summer +2 hours)  
Madagascar: +3 hours  
Madeira: 0 hours (Summer +1 hours)  
Malawi: +2 hours  
Malaysia: +8 hours  
Maldives: +5 hours  
Mali: 0 hours  
Mallorca Islands: +1 hours (Summer +2 hours)  
Malta: +1 hours (Summer +2 hours)  
Mariana Island: +10 hours  
Marquesas Islands: -9:30 hours  
Marshall Islands: +12 hours  
Martinique: -4 hours  
Mauritania: 0 hours  
Mauritius: +4 hours  
Mayotte: +3 hours  
Melilla: +1 hours (Summer +2 hours)  
Mexico: -6 hours  
Mexico Baja Calif Norte: -8 hours (Summer -7 hours)  
Mexico Nayarit: -7 hours  
Mexico Sinaloa: -7 hours.68  
Mexico Sonora: -7 hours  
Midway Island: -11 hours  
Moldova: +2 hours (Summer +3 hours)  
Moldovian Rep Pridnestrovye: +2 hours (Summer +3 hours)  
Monaco: +1 hours (Summer +2 hours)  
Mongolia: +8 hours  
Morocco: 0 hours  
Mozambique: +2 hours  
Myanmar: +6:30 hours

## **N**

Namibia: +1 hours (Summer +2 hours)



**ARGO NAVIS™**

Nauru Republic of: +12 hours  
Nepal: +5:45 hours  
Netherlands: +1 hours (Summer +2 hours)  
Netherlands Antilles: -4 hours  
Nevis Montserrat: -4 hours  
New Caledonia: +11 hours  
New Hebrides: +11 hours  
New Zealand: +12 hours (Summer +13 hours)  
Nicaragua: -6 hours (Summer -5 hours)  
Niger: +1 hours  
Nigeria: +1 hours  
Niue Island: -11 hours  
Norfolk Island: +11:30 hours  
Northern Ireland: 0 hours (Summer +1 hours)  
Northern Mariana Islands: +10 hours  
Norway: +1 hours (Summer +2 hours)

## O

Oman: +4 hours

## P

Pakistan: +5 hours  
Palau: +9 hours  
Panama: -5 hours  
Papua New Guinea: +10 hours  
Paraguay: -4 hours (Summer -3 hours)  
Peru: -5 hours  
Philippines: +8 hours  
Pingelap: +12 hours  
Poland: +1 hours (Summer +2 hours)  
Ponape Island: +11 hours  
Portugal: 0 hours (Summer +1 hours)  
Principe Island: 0 hours  
Puerto Rico: -4 hours

## Q

Qatar: +3 hours

## R

Reunion: +4 hours  
Romania: +2 hours (Summer +3 hours)  
Russian Federation zone eight: +9 hours (Summer +10 hours)  
Russian Federation zone eleven: +12 hours (Summer +13 hours)  
Russian Federation zone five: +6 hours (Summer +7 hours)  
Russian Federation zone four: +5 hours (Summer +6 hours)



ARGO NAVIS™

Russian Federation zone nine: +10 hours (Summer +11 hours)  
Russian Federation zone one: +2 hours (Summer +3 hours)  
Russian Federation zone seven: +8 hours (Summer +9 hours)  
Russian Federation zone six: +7 hours (Summer +8 hours)  
Russian Federation zone ten: +11 hours (Summer +12 hours)  
Russian Federation zone three: +4 hours (Summer +5 hours)  
Russian Federation zone two: +4 hours (Summer +5 hours)  
Rwanda: +2 hours

## **S**

Saba: -4 hours  
Samoa: -11 hours  
San Marino: +1 hours (Summer +2 hours)  
Sao Tome e Principe: 0 hours  
Saudi Arabia: +3 hours  
Scotland: 0 hours (Summer +1 hours)  
Senegal: 0 hours  
Seychelles: +4 hours  
Sierra Leone: 0 hours  
Singapore: +8 hours  
Slovakia: +1 hours (Summer +2 hours)  
Slovenia: +1 hours (Summer +2 hours)  
Society Island: -10 hours  
Solomon Islands: +11 hours  
Somalia: +3 hours  
South Africa: +2 hours  
Spain: +1 hours (Summer +2 hours)  
Sri Lanka: +5:30 hours  
St Christopher: -4 hours  
St Croix: -4 hours  
St Helena: 0 hours  
St John: -4 hours  
St Kitts Nevis: -4 hours  
St Lucia: -4 hours  
St Maarten: -4 hours  
St Pierre & Miquelon: -3 hours (Summer -2 hours)  
St Thomas: -4 hours  
St Vincent: -4 hours  
Sudan: +2 hours  
Suriname: -3 hours  
Swaziland: +2 hours  
Sweden: +1 hours (Summer +2 hours)  
Switzerland: +1 hours (Summer +2 hours)  
Syria: +2 hours (Summer +3 hours)



**ARGO NAVIS™**



## T

Tahiti: -10 hours  
Taiwan: +8 hours  
Tajikistan: +6 hours  
Tanzania: +3 hours  
Thailand: +7 hours  
Togo: 0 hours  
Tonga: +13 hours  
Trinidad and Tobago: -4 hours  
Tuamotu Island: -10 hours  
Tubuai Island: -10 hours  
Tunisia: +1 hours  
Turkey: +2 hours (Summer +3 hours)  
Turkmenistan: +5 hours  
Turks and Caicos Islands: -5 hours (Summer -4 hours)  
Tuvalu: +12 hours

## U

Uganda: +3 hours  
Ukraine: +2 hours (Summer +3 hours)  
United Arab Emirates: +4 hours  
United Kingdom: 0 hours (Summer +1 hours)  
USA Central: -6 hours (Summer -5 hours)  
USA Eastern: -5 hours (Summer -4 hours)  
USA Mountain: -7 hours (Summer -6 hours)  
USA Arizona: -7 hours  
USA Indiana East: -5 hours  
USA Pacific: -8 hours (Summer -7 hours)  
USA Alaska: -9 hours (Summer -8 hours)  
USA Aleutian: -10 hours  
USA Hawaii: -10 hours  
Uruguay: -3 hours  
Uzbekistan: +5 hours

## V

Vanuatu: +11 hours (Summer +12 hours)  
Vatican City: +1 hours (Summer +2 hours)  
Venezuela: -4 hours  
Vietnam: +7 hours  
Virgin Islands: -4 hours

## W

Wake Island: +12 hours  
Wales: 0 hours (Summer +1 hours)



ARGO NAVIS™

Wallis and Futuna Islands: +12 hours  
Windward Islands: -4 hours

## **Y**

Yemen: +3 hours  
Yugoslavia: +1 hours (Summer +2 hours)

## **Z**

Zaire Kasai: +2 hours  
Zaire Kinshasa Mbandaka: +1 hours  
Zaire Haut Zaire: +2 hours  
Zaire Kivu: +2 hours  
Zaire Shaba: +2 hours  
Zambia: +2 hours  
Zimbabwe: +2 hours



**ARGO NAVIS™**

## Appendix J—Warranty

Wildcard Innovations (Wildcard) warrants that its products shall be free from defects in materials and workmanship for a period of one year from the date of original retail purchase. Wildcard will repair or replace such product or part thereof, which, upon inspection by Wildcard, is found to be defective in materials or workmanship. As a condition to the obligation of Wildcard to repair or replace such product, the product must be returned to Wildcard together with proof-of-purchase satisfactory to Wildcard.

The Proper Return Authorization Number must be obtained from Wildcard in advance of return. Email customer service at [sales@wildcard-innovations.com.au](mailto:sales@wildcard-innovations.com.au) to receive the number to be displayed on the outside of your shipping carton.

All returns must be accompanied by a written statement setting forth the name, address, daytime telephone number and/or email address of the owner, together with a brief description of any claimed defects. Parts or product for which replacement is made shall become the property of Wildcard.

The customer shall be responsible for all costs of transportation and insurance, both to and from the Wildcard repair facility, and shall be required to prepay such costs. The customer shall be responsible for carrying out all firmware upgrade procedures when firmware is made available to correct defects or otherwise.

Wildcard shall use reasonable effort to repair or replace any product covered by this limited warranty within thirty days of receipt. In the event repair or replacement shall require more than thirty days, Wildcard shall notify the customer accordingly. Wildcard reserves the right to replace any product that has been discontinued from its product line with a new product of comparable value and function. In the event no product of comparable value and function is then marketed by Wildcard, Wildcard may, in lieu of replacement, pay the current fair market value of the product in serviceable condition.

This warranty shall be void and of no force of effect in the event a covered product has been modified in design or function, or subject to abuse, misuse, mishandling or unauthorized repair or has been damaged through the use of cables or components not supplied or directly endorsed by Wildcard. Misuse shall include failure to observe all warnings within this manual. Further, product malfunction or deterioration due to normal wear is not covered by this warranty.

Wildcard disclaims any warranties, express or implied, whether of merchantability or fitness for a particular use, except as expressly set forth herein.

The sole obligation of Wildcard under this limited warranty shall be to repair or replace the covered product, in accordance with the terms set forth herein. Wildcard expressly disclaims any lost profits, general, special, indirect or consequential damages which may result from breach of any warranty, or arising out of the use or inability to use any Wildcard product. Any warranties which are implied and which cannot be disclaimed shall be limited in duration to a term of one year from the date of original retail purchase.

Some countries and states do not allow the exclusion or limitation of incidental or consequential damages or limitation on how long an implied warranty lasts, so the above limitations and exclusions may not apply to you.

This warranty gives you specific legal rights, and you may also have other rights that vary from country to country and state to state.

Wildcard reserves the right to modify or discontinue, without prior notice to you, any of its products.



If warranty problems arise, or if you need assistance in using your Wildcard product, contact:

**Your ARGO NAVIS™ dealer from whom you purchased the unit**

**or**

**[sales@wildcard-innovations.com.au](mailto:sales@wildcard-innovations.com.au)**

**Wildcard Innovations Pty. Ltd.**

**20 Kilmory Place**

**Mount Kuring-Gai NSW 2080**

**Australia**

**Phone +61 2 9457 9049**

**Fax +61 2 9457 9593**

**Monday-Friday 9AM-5PM AEST**

**<http://www.wildcard-innovations.com.au/>**

This warranty supersedes all other product warranties. This warranty is valid to customers who have purchased this product from an Authorized Wildcard dealer.



**ARGO NAVIS™**

## Appendix K—Conformance

### FCC CONFORMITY

**Note:** This equipment has been tested and found to comply with the limits for a Class B digital device, pursuant to part 15 of the FCC Rules. These limits are designed to provide reasonable protection against harmful interference in a residential installation.

This equipment generates, uses and can radiate radio frequency energy and, if not installed and used in accordance with the instructions, may cause harmful interference to radio communications. However, there is no guarantee that interference will not occur in a particular installation.

If this equipment does cause harmful interference to radio or television reception, which can be determined by turning the equipment off and on, the user is encouraged to try to correct the interference by one or more of the following measures –

- Reorient or relocate the receiving antenna.
- Increase the separation between the equipment and receiver.
- Connect the equipment into an outlet on a circuit different from that to which the receiver is connected.
- Consult the dealer or an experienced radio/TV technician for help.

Modifications not expressly approved by the manufacturer could void the user's authority to operate the equipment under FCC rules.





**ARGO NAVIS™ Model 102**  
**Declaration of Conformity**

**Manufacturer's Name:** Wildcard Innovations Pty. Ltd.

**Manufacturer's Address:** 20 Kilmory Place, Mount Kuring-Gai, NSW 2080 Australia

**declares, that the product**

**Product Name:** Argo Navis

**Model Number:** Model 102

**conforms to the following Product Specifications**

**EMC:** EN55022:1998 Class B Complies  
EN55024:1998 EN61000-4-2 Complies, Criterion A  
EN61000-4-3 Complies, Criterion A

**Supplementary Information:**

This unit is not for mains connection.

The product was tested by EMC Technologies Pty. Ltd. Castle Hill, NSW, Australia.

Wildcard Innovations  
Mount-Kuring-Gai NSW  
21 July 2002



**ARGO NAVIS™**

## ARGO NAVIS™ Model 102 C-Tick Declaration of Conformity

**Manufacturer's Name:** Wildcard Innovations Pty. Ltd.

**Manufacturer's Address:** 20 Kilmory Place, Mount Kuring-Gai, NSW 2080 Australia

**Australian Business No.** 56 076 242 240

**ACA Supplier's Code:** N11511

**declares, that the product**

**Product Name:** Argo Navis

**Model Number:** Model 102

**conforms to the following mentioned standards**

**EMC:** AS/NZS 3548 Class B Complies  
AS/NZS 61000-4-3 Complies, Criterion A

**Supplementary Information:**

This unit is not for mains connection.

The product was tested by EMC Technologies Pty. Ltd. Castle Hill, NSW, Australia.

Wildcard Innovations  
Mount-Kuring-Gai NSW  
21 July 2002



ARGO NAVIS™



## Appendix L—Glossary

**Asterism** — a group of stars that is neither a constellation nor an open cluster.

**Baud rate** — the communications speed of a serial port.

**BOOT LOADER mode** — the mode in which ARGO NAVIS™ is placed in order to have its firmware upgraded. To put the unit in BOOT LOADER mode, power it off, press and keep depressed **EXIT** and power it on. Then release the **EXIT** button.

**Celestial Pole** — the point in the sky around which the stars appear to rotate. In the Northern Hemisphere the North Celestial Pole (NCP) is at Declination +90°. The closest bright star is Polaris. In the Southern Hemisphere, the South Celestial Pole (SCP) is at Declination -90°. The closest bright star (Magnitude 5.4) is Sigma Octantis.

**Current Object** — a term used to refer to the last object referenced either in MODE ALIGN, MODE ALIGN STAR, MODE CATALOG, MODE IDENTIFY or MODE TOUR.

**Declination** — the celestial equivalent to latitude. Measured in degrees. See Right Ascension.

**Detent** — a mechanical catch that regulates something to move. The ARGO NAVIS™ **DIAL** has detent “clicks” that you can feel when you rotate it.

**EEROM** – Electrically Erasable Read-Only Memory. ARGO NAVIS™ uses EEROM to store such parameters as your mount type, location and encoder resolution settings so that these values may be retained even when the power is switched off or if the batteries are removed.

**Encoder** — an electro-mechanical device that creates pulses when its shaft is rotated. Encoders are fitted to your telescope on each of its two axes and are the means by which your telescope computer can determine where the telescope is pointing.

**Firmware** — a term used to describe software that is embedded in an electronic appliance such as the ARGO NAVIS™



ARGO NAVIS™

**FLASH** — a type of high-speed electronic memory that can be written to and erased electrically. ARGO NAVIS™ uses FLASH memory to store its firmware and catalogs, including user-loadable catalogs. Firmware and catalogs can be downloaded from a PC using the supplied ARGONAUT™ software utility.

**Hubble Morphology** — a system for classifying a galaxy based on its appearance. For example, whether it is spiral, spiral-barred, elliptical, irregular, peculiar, etc. ARGO NAVIS™ uses a succinct notation used by astronomers to describe galaxy morphologies.

**J2000.0 Epoch – 12:00 UTC, 1st January 2000.** Due to the effects of precession, nutation and proper motion, the positions of objects are catalogued by astronomers according to where they were at some moment in time, or 'Epoch'. The 'J' stands for Julian and refers to the time-keeping system used. Older catalogs often have B1950.0 positions. In this case, 'B' stands for Besselian. It is the current convention of the International Astronomical Union (IAU) that celestial co-ordinates are reported with respect the fixed International Celestial Reference Frame (ICRF) which is for practical purposes the same as the previous FK5 J2000.0 co-ordinate system. This co-ordinate system remains invariant to the effects of precession and nutation and so by IAU convention, all object positions are reported according to where an object happened to be at midday UTC on 1 Jan 2000. ARGO NAVIS™ follows the IAU convention and displays RA and Dec values with respect the ICRF.

**Julian Date** — the number of days that have elapsed since Julian day 0 on 1 January 4713 BC Julian.

**Meridian** – an imaginary circle passing North-South through the celestial poles and the zenith directly above you.

**Nadir** — the point directly beneath you (opposite to zenith)

**Nutation** — an approximately 11,000 year “wobble” in the Earth’s axis that causes an apparent displacement of the stars when viewed from the Earth. See Precession.

**Precession** — an approximately 25,000 year “wobble” in the Earth’s axis that causes an apparent displacement of the stars when viewed from the Earth. See Nutation.



Refraction — the bending of light rays through the atmosphere that causes objects close to the horizon to appear higher in altitude than they actually are.

Real Time — a computing term used to describe a system that responds extremely quickly to external events. As you move your telescope, ARGO NAVIS™ has sufficient compute power to respond in real-time.

Right Ascension — the celestial equivalent to longitude. Abbreviated as RA. Measured in hours, minutes, seconds. See Declination.

RS-232 — designation of a computer serial communications standard. Not to be confused with Universal Serial Bus (USB). ARGO NAVIS™ is fitted with two independent RS-232 serial ports. Some PC's have a 9-way RS-232 serial male D-connector. However, some newer machines do not have RS-232. In this case, either install a PCI or PCIe serial card or use a USB Serial Adapter. Wildcard Innovations recommends the Keyspan USA-19HS.

RTC — Real Time Clock. ARGO NAVIS™ battery-backed time of day clock.

Shell — the name of a command interpreter program that runs on each ARGO NAVIS™ serial port. The "shell" accepts the names of programs and other command parameters (called arguments) on a command line and then calls upon the ARGO NAVIS™ multi-tasking operating system to run them.

Sidereal — 'Star' time – the rate at which stars appear to move across the sky. The orbit of the Earth around the Sun makes the Sun appear to drift eastward about 1° per day with respect to the stars. In one year, when the earth has completed 365.2422 rotations with respect to the sun, it has made exactly 1 additional rotation with respect to the stars. Therefore 1 year is equivalent to 366.2422 sidereal days. This makes for a Sidereal Day being approximately 4 minutes shorter than a Synodic or 'solar' day.

Synodic — 'Sun' time. The familiar rate of time like that which occurs on a wristwatch.

Time zone — the number of hours and minutes the local time is offset from Universal Co-ordinated Time (UTC).

Topocentric — on the Earth's surface. A topocentric Azimuth-Altitude co-ordinate system is one centred on the observer's location on the surface of the Earth. A topocentric Altitude



of  $0^\circ$  corresponds to the local horizon and that of  $90^\circ$  to the zenith. A topocentric Azimuth of  $0^\circ$  is due North and that of  $90^\circ$  due East.

UTC — Universal Co-ordinated Time. For practical purposes, very close to the Greenwich Mean Time (GMT) time reference.

Zenith — the point in the sky directly above you (opposite nadir).



ARGO NAVIS™

## Index

- Alignment procedures
  - AUTO ADJUST ON, 62
  - dobsonians, 26
  - fork rough align, 28
  - GEM rough align, 29
  - introduction, 25
  - MODE ALIGN, 39
  - MODE ALIGN STAR, 41
  - MODE FIX ALT REF, 60
- Argonaut
  - clock scaling, 198
  - date/time setting, 196
  - establishing communication, 175
  - firmware transfer, 194
  - functions, 166
  - installation, 167
  - orbital element file sources, 180
  - running, 175
  - setups transfer, 189
  - software utility, 166
  - transferring catalogs, 184
  - updating catalogs, 187
  - user catalog format, 182
- asteroid
  - command, 212
- battery
  - coin cell replacement, 241
- battery power, 12
  - external, 13
  - internal, 12
- Baud rate
  - definition, 262
- BOOT LOADER
  - definition, 262
- catalogs
  - listing, 234
  - MODE CATALOG, 46
- celestial pole
  - definition, 262
- comet
  - command, 213
- Conformance
  - CE, 260
  - FCC, 259
- date
  - command, 214
  - Setting via SETUP DATE/TIME, 103
- daytime encoder test
  - how to perform, 128
- declination
  - definition, 262
- detent
  - definition, 262
- DIAL, 9
- enc
  - command, 215
- encctl
  - command, 216
- encoder
  - direction senses, 17
  - errors, 16
  - interface, 9
  - sampling rate, 54
  - SETUP ENC TIMING, 108
  - slipping, 55
  - technical background, 14
  - test procedure, 16
  - testing with MODE ENCODER, 53
- equatorial table
  - MODE EQ TABLE, 57
- event
  - command, 217
- fp
  - command, 218
- Glossary, 262
- Hubble morphology
  - definition, 263
- Initial setup**, 12
- interfaces, 8
- J2000.0
  - definition, 263
  - MODE RA DEC, 72
  - relation to ICRF, 72
- Julian Date
  - definition, 263
- LCD
  - brightness adjust, 101
  - contrast adjust, 102
  - heater, 119
  - liquid crystal display, 8
- Linux
  - file transfer utilities, 204
- MAC OS-X
  - Argoload file transfer utility, 205
- meade
  - startup command, 219
- meridian
  - definition, 263
- MODE ALIGN, 39
  - aligning on any object, 39



ARGO NAVIS™

- MODE ALIGN STAR, 41
- MODE AZ ALT, 45
- MODE CATALOG
  - below horizon indicator, 50
  - below horizon indicator example, 52
  - detailed object description, 49
  - FROM PLANETARIUM, 46
  - Intelligent Editing System, 47
  - introduction, 46
  - manual scroll of description, 50
  - Moon phase, 51
  - PLANETS/SUN/MOON, 47
  - scrolling description, 50
  - sequential stepping of items, 49
- MODE ENCODER, 53
- MODE EQ TABLE, 57
- MODE FIX ALT REF
  - introduction, 60
  - using, 62
- MODE IDENTIFY
  - below horizon indicator, 68
  - constellation filter, 65
  - horizon mask filter, 66
  - introduction, 64
  - magnitude filter, 65
  - object filter, 64
  - within filter, 66
- MODE RA DEC, 71
- MODE SETUP, 73
- MODE SIDEREAL, 75
- MODE STATUS
  - introduction, 76
  - STATUS POWER, 76
  - STATUS SETUP, 76
  - STATUS THERMAL, 76
- MODE TIME, 78
- MODE TIMER, 79
- MODE TOUR
  - below horizon indicator, 85
  - constellation filter, 82
  - horizon mask filter, 82
  - introduction, 80
  - magnitude filter, 81
  - object filter, 81
  - rejoin last tour, 85
  - within filter, 82
- Moon phase
  - MODE CATALOG, 51
- nadir
  - definition, 263
- navis
  - startup command, 221
- nutations
  - definition, 263
- Operating modes
  - menus, 37
- pbt
  - startup command, 222
- Port pin descriptions, 238
- power sources, 12
- precession
  - definition, 264
- Programmer's reference, 211
- rad
  - command, 223
- Right Ascension
  - definition, 264
- RS-232
  - definition, 264
- samples
  - command, 224
- satellite
  - command, 225
- servocat
  - alarm sounds SETUP GOTO, 114
  - interfacing to, 206
  - operation with, 207
  - satellite tracking, 208
  - SETUP GOTO, 113
  - SmartTrack, 207
  - startup command, 226
  - using with Argo Navis, 206
- Setting
  - encoder steps, 14
  - location, 22
  - mount type, 14, 18
  - refraction, 24
- SETUP ALIGN PICK, 87
- SETUP ALT REF, 90
- SETUP ALT STEPS, 92
- SETUP ARCHIVE, 93
- SETUP ATLAS, 98
- SETUP AZ STEPS, 100
- SETUP BRIGHTNESS, 101
- SETUP CONTRAST, 102
- SETUP DATE/TIME, 103
- SETUP DEBUG, 106
- SETUP DEFAULTS, 107
- SETUP ENC TIMING, 108
- SETUP EQ TABLE, 111
- SETUP GOTO, 113
- SETUP GUIDE MODE
  - arrow sense change, 117
  - BELOW HORZ H indicator, 118
  - GUIDE DECIMALS, 117
  - introduction, 116
- SETUP LCD HEATER, 119
- SETUP LOAD CAT, 121



- SETUP LOCATION, 123
- SETUP MNT ERRORS, 127
- SETUP MOUNT, 126
- SETUP REFRACTION, 157
- SETUP SCRATCH, 159
- SETUP SCROLL, 161
- SETUP SERIAL, 162
- setups
  - command, 227
  - transferring to/from PC, 189
- sitech
  - SETUP GOTO, 113
  - startup command, 228
- skycomm
  - startup command, 229
- synodic
  - definition, 264
- tangent
  - startup command, 230
- Technical specifications, 236
- therm
  - command, 231
- time
  - local apparent sidereal time (LAST), 75
  - MODE TIME, 78
  - Network Time Protocol, 196
  - setting via Argonaut, 198
  - SETUP/DATE/TIME, 103
  - software clock scaling, 198
- timezone. See Mode Time
  - by country, 248
- setting. See SETUP DATE/TIME
- topocentric
  - definition, 265
- TPAS
  - ACQUIRE DATA submenu, 142
  - COMPUTE submenu, 146
  - DEFINE MODEL submenu, 145
  - pointing terms, 132
  - polar align assist, 156
  - recommended number of stars, 154
  - REVIEW DATA submenu, 151
  - RMS (Root Mean Square), 131
  - sampling stars, 143
  - SET ERROR VALUES submenu, 149
  - Standard Deviation, 148
  - Telescope Pointing Analysis System, 130
  - what terms to use, 155
- uptime
  - command, 232
- user
  - command, 233
  - user interface, 8
- UTC
  - Universal Co-ordinated Time, 265
- WARP factor
  - definition, 42
- Warranty, 257
- World time zones
  - by country, 248
- zenith
  - definition, 265



ARGO NAVIS™



Products, instructions or specifications may change without notice.

Wildcard Innovations Pty. Ltd.  
20 Kilmory Place, Mount Kuring-Gai, NSW 2080 Australia

ABN 56 076 242 450

Phone +61-2-9457-9049

Fax +61-2-9457-9593

<http://www.wildcard-innovations.com.au/>

Sales & Support Enquiries

[sales@wildcard-innovations.com.au](mailto:sales@wildcard-innovations.com.au)

Corporate & other Enquiries

[wildcard@wildcard-innovations.com.au](mailto:wildcard@wildcard-innovations.com.au)

ARGO NAVIS™, ARGONAUT™, *Intelligent Editing System™*, *SmartTrack™*, *Telescope Pointing Analysis System™* and **TPAS™** are trademarks of  
Wildcard Innovations Pty. Ltd.

All other trademarks belong to their respective owners.

© Copyright 2002-2014 Wildcard Innovations Pty. Ltd.

Printing of a single copy of this User Manual for personal use permitted.



ARGO NAVIS™